

SPECIFICATION

inline

HINGE DOOR 3 SIDED

RANGE	INLINE
PRODUCT	HING DOOR 3 SIDED
CODE	AQ1037S
SIZE	1400x800
PROFILE COLOUR	SILVER
GLASS THICKNESS	8mm
GLASS FINISH	CLEAR
GLASS TREATMENT	CLEAN & CLEAR™
HEIGHT	1950
ADJUSTMENT IN RECESS	N/A
ADJUSTMENT WITH SIDE PANEL	760-785 (S.P)
OPTIONAL SIDE PANEL	YES
APERTURE	632
GUARANTEE	LIFETIME
CE	EN14428
GLASS BS EN	EN12150-1T
PROFILE MATERIAL	ALUMINUM/6463#
HANDLE MATERIAL	STAINLESS STEEL
ROLLER MATERIAL	N/A
QUICK RELEASE ROLLERS	N/A
FIXED PANEL SIZE	337.5x2/703.5x2 (S.P)
MOVING PANEL SIZE	650
PRODUCT HAND	UNIVERSAL
PRODUCT WEIGHT	122KG
PACKAGED DIMENSIONS	2030x786x240
BARCODE	5031978034310

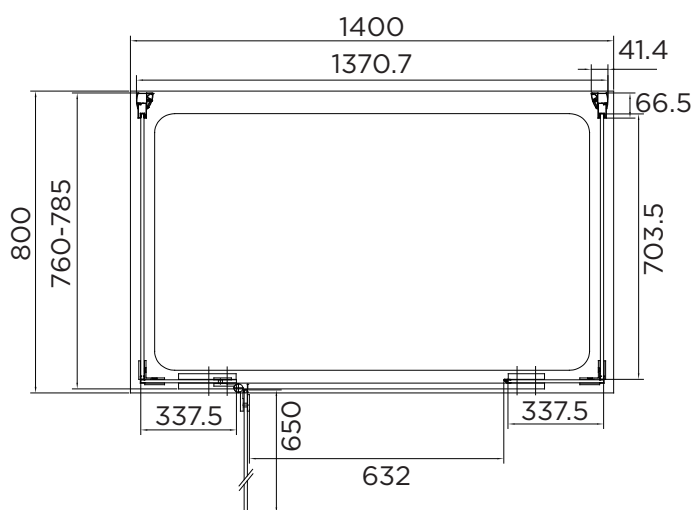

*All shower enclosures carry a Lifetime Guarantee when fitted with an Aquadart shower tray, a 10 year Guarantee will be given when fitted with any other manufacturer's tray.

To register your Guarantee visit: www.aquadart.co.uk | Spare Parts available at: www.aprilaquadartspares.co.uk

All measurements in mm and are nominal