



The  
Radiator  
Company



**2022 Brochure & Price List 2<sup>nd</sup> Edition**



Our Brochure is available through Easyquote software making quoting & ordering easier.



# The Radiator Company

The largest selection of designer radiators and towel rails to suit any home interior.

## Design

---

- Over 52 exclusive and affordable designs.
- Italian design & manufacture.
- Efficient low water content designs saving energy and reducing running costs.

## Choice

---

- UK's largest brochure selection of radiators and towel rails.
- Over 1250 sizes and colours are available from stock, delivered in 48-72 hours.
- Thousands of Made to Order options in over 200 colours and special finishes.
- Sectional Specialists in Steel Multi Column, Aluminium and Cast Iron.

## Service

---

- A dedicated UK Customer Service Team to make your purchase as smooth as possible.
- Order from our network of Plumbing & Heating Merchants including over 500 Showrooms nationwide.
- Free Delivery on all radiators and towel rails to UK mainland Showrooms and Merchants.
- Minimum 10-Year Guarantee on all radiators and towel rails.
- All radiators and towel rails are CE/UKCA approved and certified to BS EN442.

---

The Radiator Company is a brand of **IRSAP**, Italy's leading manufacturer of design led radiators.





# Radiators

**New** Colour Coordination Service (pages 6-7 / 196)

## Steel Multi Column (pages 8-31 / 128-149)

	<b>Product</b>	<b>Technical</b>
Ancona® Stock	8-17	128-137
Ancona® Made to Order	18-27	138-145
Ancona® Bench Seat	28-29	146-147
Ancona® Curved	30	148
Ancona® Electric	31	149

## Contemporary Designer (pages 32-63 / 150-175)

	<b>Product</b>	<b>Technical</b>
Ceramica Collection	34-35	150
Torré	36-37	151
Niro	38-39	152
Iseo	40-41	153
Sebino	42-43	154
Odolo	44-45	155
Canto	46	156
Ellipsis Stainless Steel	47	157
Ellipsis	48-49	158-161
Sitar	50-51	162-165
Sax	52-53	166-167
Piano	54-55	168-169
Water Lily	56	170
Immagina	57	171
Athena	58-59	172
Relax	60-61	174-175
Halo	62-63	173

## Sectional Aluminium (pages 64-73 / 176-185)

	<b>Product</b>	<b>Technical</b>
Vip	66-67	178-179
Oscar	68-69	180-181
Vox	70-71	182-183
Mix	72-73	184-185

## Traditional Cast Iron (pages 74-87 / 186-195)

	<b>Product</b>	<b>Technical</b>
Ledbury	76-77	188-189
Aston	78-79	187
Telford	80-81	190-191
Linton	82-83	192-193
Trieste	84-85	194
Bohemia	86-87	195

## Towel Rails (pages 88-115 / 198-216)

	Product	Technical
Step BDO	90	198
Step	91	199
Athena BDO	92	200
Athena Towel Rail	93	200
Relax Bagno	94	201
Echo	95	202
Piano Towel Rail	96	203
Piano Lato	97	202
Quadre	98	204
Griffin	99	205
Pulsar	100	206
Ellipsis Towel Rail	101	207
Sitar Lato	102	208
Sitar BDO	103	208
Poll BDO	104	209
Poll	105	210
Poppy	106-107	211
Lupin	108-109	212
Iris	110-111	213
Blues	112	206
Chalfont Range	113	214-215
Lingfield	114	216
Linton Towel Rail	115	216

## Valves & Accessories (pages 116-127)

Heating Elements	116-117
Valves	118-125
Accessories	126-127

## Technical Details & Prices (pages 128-216)

For details of our convector range (Trench & Mini), full Terms & Conditions and to find your local showroom or merchant: **01342 302250** or visit **theradiatorcompany.co.uk** where you will also find helpful tools such as our **heat output (BTU) calculator** as well as our **curved** and **sectional radiator builder**.

**Index** (page 217)

**Helpful Advice & How to Buy** (pages 218-219)



# Colour Coordination New



We understand that many interior designs can be enhanced with carefully applied colour coordination or contrasts to create a standout feature. Today we have a huge choice of brands and exciting colour palettes and tones to choose from for our walls and woodwork, providing the opportunity to create truly stunning rooms. If you are looking to create a uniquely personal look using colours from either popular or premium paint brands, we can take your chosen colour and create a highly durable powder coat finish that will allow your radiator to blend in with your wall colour, or stand out if you want to make a statement!



*Ancona radiator with matching Pistol TRVs, pipe covers and shrouds colour coordinated to Benjamin Moore paint Aegean Teal (2136-40)*

The first step is to order a colour sample, for which a small charge of £120 inc VAT will apply (this will be deducted from the full order when placed). We will then mix a batch of powder and prepare a sample for you to check and approve. Once you are happy, you can proceed to order your radiators. To achieve your desired colour and allow for the sample and final production, we have an extension on our standard delivery times to allow for the process, this could be up to 6 weeks for the sample, and once the sample has been approved, up to 8 weeks for the completion of your radiator order.

Timescales will be determined by the size and quantity of radiators you require, we will be able to provide a more accurate estimation when we quote for your project.



*Ledbury radiator colour coordinated to Benjamin Moore paint Van Deusen Blue (HC-156)*

Making sure that you get something that reflects the effort you have taken in choosing your colours is important. Once we know the radiators you are interested in and the make, name and code of your chosen colour, we can supply a quote and an estimate of delivery times.



*Oscar radiator with matching Pistol TRVs, pipe covers and shrouds colour Coordinated to Dulux Natural Slate paint*

Because our radiators are finished using a bespoke powder coat application, they will differ from the final wall finish of an emulsion paint. Each manufacturer has a unique formula and the gloss level and finished texture will vary between brands, a powder coat finish will not match these finishes exactly. Our powder coat finish will have a gloss level of circa 20-25%, like an eggshell, many matt emulsions will have gloss levels of around 2 – 6%, so it is important to provide a test sample before we proceed with the complete order, so you can see how it sits next to your wall colour.



*Sitar radiator colour coordinated to Farrow & Ball® paint Citron 74*



*Sitar radiator colour coordinated to Farrow & Ball® paint Citron 74 contrasted with Mid Brunswick Green*

### The process is simple;

- 1) Choose your radiators from our stock white range, we need to know the number and size of radiators that will need painting, so we can calculate the amount of powder we will need. If you would like a size that is not a stock item, additional time will be required to produce your chosen radiator. Timescales will be determined by the size and quantity of radiators you require, we will be able to provide a more accurate estimation when we quote for your project. **Please note that sometimes we will require a physical sample to colour match from.**
- 2) We will provide a full quote for the estimated costs and timescales for producing your radiators in your chosen colour, including the initial £120 Inc VAT charge for a test sample.
- 3) Place and pay for an order for a test sample in your chosen colour (which will be deducted from the final order), providing the make, colour name and any code references. The £120 Inc VAT charge will apply for each sample required.
- 4) If you like the test sample, we will require your written approval before we can proceed with the full order. If the sample is not satisfactory, we can either try again (a second sample charge will apply, we can however only refund the first sample cost off the final order), we can amend your order to a standard colour, or we can cancel the order.
- 5) We will supply a final order summary for your approval before progressing with production.

To achieve your desired colour and allow for the sample and final production, we have an extension on our standard delivery times to allow for the process, this could be up to 6 weeks for the sample, and once the sample has been approved, up to 8 weeks for the completion of your radiator order. Estimated delivery times will be supplied when we provide a quote for the project.



The colour coordination icon indicates which products are available for this service and are shown on the relevant technical pages. Please call us on **01342 302250** or visit **theradiatorcompany.co.uk** for more information.

# Ancona® - Steel Multi Column

Italy, has earned an outstanding worldwide reputation for being at the leading edge of radiator design, style and practical functionality. Produced in our factory in Italy the Ancona® range of Steel Multi Column radiators take the classic look of cast iron and combines it with the flexibility of steel; suitable for all interiors. Multiple column depths, heights and widths provide an extensive choice of sizes and outputs to suit any room or location.

## Stock (pages 10-17)

Our stylish and timeless stock Ancona® Steel Multi Column is held in our UK warehouse for fast delivery

The most popular 2, 3 or 4 column sizes in 5 height options and 3 mounting options are available from stock;

- White RAL 9016 delivered in 48-72 hours
- Bare Metal Lacquer delivered in 48-72 hours.
- Feature Finishes: Copper, Textured Anthracite & Pearl Bronze in up to 3 weeks.
- **New** Colour Coordination service, price and lead time on application see pages 6-7.

We list all possible combinations on pages 130-137 in the technical section.



## Made To Order (pages 18-27)

The perfect solution, made to order in our Italian factory to fit your requirements.

We offer a vast range of sizes of Ancona Multi Column in 2-6 column options; with 3 different mounting options wall-hung, cast feet or welded feet. Added to this we have over 188 RAL colours plus 34 special finishes including Galvanised & Bare Metal Lacquer.

Combine all these choices and you have over 3 million combinations of sizes, colours and mounting options. To help make selection easier please use our **online radiator builder**, a simple way to select the best size, options and heat requirements for your space.



® Ancona is a registered trademark of IRSAP UK Limited



# Ancona® - Finishes & Options



## Ancona® Bare Metal Lacquer (pages 16-17)

This industrial bare metal finish is hand finished so every radiator is unique. Variations in colour, welding and burnishing marks differ from one section to another and add to the idiosyncrasy of each radiator. Once sections are hand burnished to give a smooth surface, a clear gloss lacquer is applied, protecting the bare metal and enhancing their irregular nature and individuality. **We offer a large range of stocked sizes, see pages 136-137.**



Antique Brass

Antique Copper

Satin Nickel

## Ancona® Galvanised (pages 26-27)

We have developed a range of truly unique, stunning and “on trend” finishes; Antique Copper, Antique Brass & Satin Nickel. The finish is created by hand polishing individual sections of Ancona®, and then using a galvanising process (similar to chroming). 5 stages in total are needed to complete the look with a final hand brushing & application of a protective lacquer. The result is distinctive & hardwearing, with each radiator unique & individual. Please note: Galvanised Ancona’s are available with welded feet only. **See pages 144-145 for full range of sizes.**

## Ancona® Bench Seat (pages 28-29)

A practical solution providing both seating and heating, perfect for boot rooms, utility rooms and conservatories. The Ancona bench seat comes supplied with a solid wooden top. **See pages 146-147 for full range of sizes.**



## Ancona® Curved (page 30)

Fitting a curved Ancona into your bay window or around a curved wall will give a truly bespoke finish to a room. All come with welded feet as standard & are available in 188 RAL colours & 30 special finishes. Use our **curved radiator builder online** or download the easy to follow Specification Instructions on our website [theradiatorcompany.co.uk](http://theradiatorcompany.co.uk) .

## Ancona® Electric (page 31)

Our range of fully electric Ancona sizes provide the option to place your radiator in spaces where it is not possible or convenient to connect to the normal heating system. Available in one height (600mm) there are 7 sizes available with 3 sizes now available from stock. These radiators are filled with an oil/glycol mix and are IP24 rated.

**See page 149 for full range of sizes.**



® Ancona is a registered trademark of IRSAP UK Limited

Ancona® stock radiators are incredibly versatile with literally hundreds of possible sizes in 2, 3 or 4 columns from 3-40 sections, in a choice of 3 mounting options (slip on welded feet, cast feet or 2 types of wall brackets) all available from stock.

Please visit our sectional radiator builder online [theradiatorcompany.co.uk](http://theradiatorcompany.co.uk).

## Design

### Ancona® from stock

Our stylish and timeless Ancona® Steel Multi Column is held in our UK warehouse for fast delivery.

- White RAL 9016 delivered in 48-72 hours
- Bare Metal Lacquer delivered in 48-72 hours
- Feature Finishes; Copper, Pearl Bronze & Textured Anthracite delivered in up to 3 weeks
- 2, 3 & 4 column options
- 5 heights; 300mm, 500mm, 600mm, 750mm & 1800mm
- 3 mounting options; Slip-on Welded Feet, Wall Brackets & Cast Feet
- Up to 40 pre-assembled sections, nipple & gasket joined
- 10-year guarantee



White RAL 9016

Copper

Textured Anthracite

Pearl Bronze

See our full Stocked range of over 360 sizes on pages 130-137

## Choice

### Columns

Ancona® stock radiators can be specified in either 2, 3 or 4 column depths in over 360 sizes in up to 40 sections.



2 Column



3 Column



4 Column

### Mounting Options

Ancona® stock (excluding lacquer) can be mounted in one of 3 ways;

- Slip-on Welded Feet; for a contemporary look
- Cast Feet; for a classic look
- Wall Brackets to position your steel multi column at any height

Stock Bare Metal Lacquer radiators can be wall or floor mounted with universal brackets or slip on welded feet, please see pages 136-137 for more information.

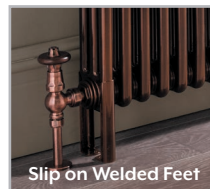

Slip on Welded Feet

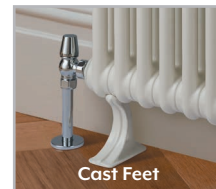

Cast Feet

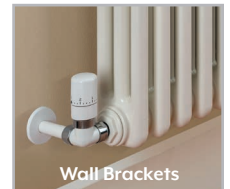

Wall Brackets

### Ancona® Towel Bars & Pegs

Made from steel and chromed, Ancona® towel bars can be added to Ancona® radiators to provide useful hanging space in kitchens or bathrooms. **Available from stock in 48-72 hours see page 127.**



## Service

**All Ancona® stock white and bare metal lacquer models are delivered in 48-72 hours.**

**Feature Finishes: Copper, Textured Anthracite & Pearl Bronze are available in up to 3 weeks.**



**New Colour Coordination Service - please see pages 6-7 for full details and how to order.**

**Save £45 with our valve kit promotion, see product pages at the back of the brochure for full details**

\*Saving based on the value of individual items when bought separately. Order any of our selected valves and matching pipe covers at the same time as your radiator.

Choose from our full list of Ancona® sizes on pages 128-137 or by using our online radiator builder to select the best solution for your room. It will take you through the process quickly and easily and allows you to save your ideas to your own Wish List. Go to our website [theradiatorcompany.co.uk](http://theradiatorcompany.co.uk).

© Ancona is a registered trademark of IRSAP UK Limited



# Ancona<sup>®</sup> 2 Column

Stocked White



New Colour Coordinating service

Cast Feet, 1800mm x 386mm with Chrome Vintage TRVs.

# Ancona<sup>®</sup> 3 Column

Stocked White

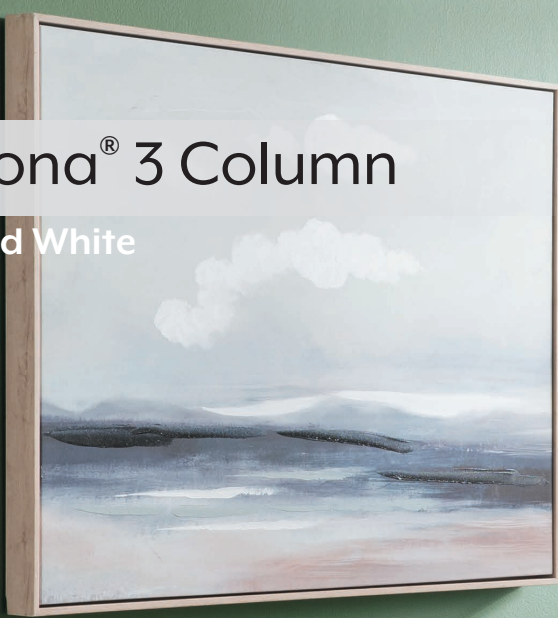

Wall Brackets, 500mm x 836mm with Chrome Corner Ideal TRVs

# Ancona<sup>®</sup> 4 Column

Stocked White



**New** Colour Coordinating service

Slip on Welded Feet, 750mm x 836mm with White Ideal TRVs

# Ancona® Textured Anthracite

## Feature Finishes



Textured Anthracite finish with Wall Brackets, 4 column, 600mm x 1196mm with Nickel Vintage TRVs

# Ancona<sup>®</sup> Copper

Feature Finishes



Pearl Bronze

Copper finish with Wall Brackets, 2 column, 1800mm x 476mm with Antique Copper Vintage XL TRVs.

# Ancona<sup>®</sup> 3 Column

Stocked Lacquer

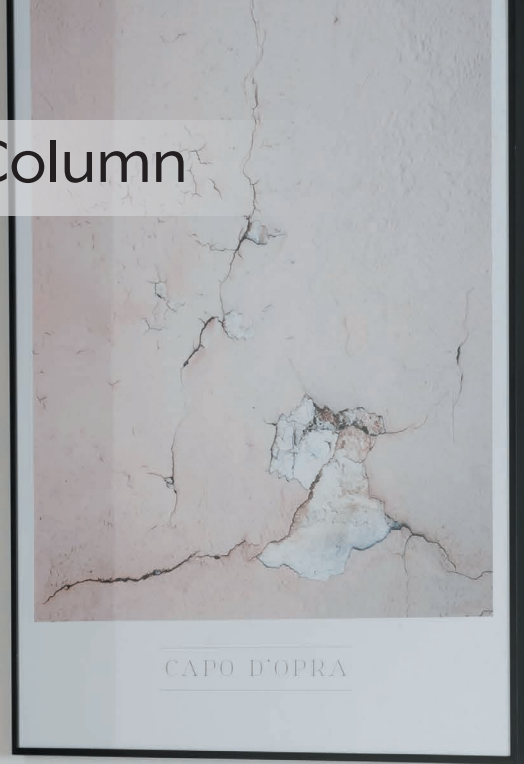

With Slip on Welded Feet, 600mm x 926mm with Nickel Vintage XL TRVs.





# Ancona<sup>®</sup> 2 Column

Stocked Lacquer



With Slip on Welded Feet, 1800mm x431mm with Nickel Vintage XL TRVs.

# Ancona® - Made to Order

Produced in our Italian factory our made to order range of Ancona® steel multi column is the largest range in the UK, allowing maximum flexibility to create a radiator that matches your exact requirements. We offer over a vast range of Ancona Multi column in 2, 3, 4, 5 and 6 column options, with 3 different mounting options wall-hung, cast feet or welded feet.

Please visit our sectional radiator builder online [theradiatorcompany.co.uk](http://theradiatorcompany.co.uk).

## Design

Prices from £167.00

### Ancona® Made to Order

- 2-6 column options
- 25 heights; 195mm up to 2500mm
- 3 mounting options; Welded Feet, Cast Feet or Standard Wall Brackets
- Up to 40 sections factory welded (40+ sections requires site assembly)
- 10-Year Guarantee
- 188 RAL colours including RAL 9016 as standard plus 34 special finishes
- Up to 4 week delivery for standard white, RAL colours and special finishes
- Up to 6 weeks for bare metal lacquer, up to 10 weeks for galvanised

See our full Made To Order range on pages 20-27

For sizes available direct from stock please see pages 128-137



## Choice

### Columns

All made to order Ancona® radiators can be specified in either 2, 3, 4, 5 or 6 column depths, this allows you to achieve the output you require in the space you have available.



2 column



3 column



4 column



5 column



6 column

### Mounting Options

Our Ancona® made to order can be mounted in one of three ways: Welded Feet, Cast Feet, and Wall Brackets. Wall Brackets will allow you to position your steel multi column radiator at any height.

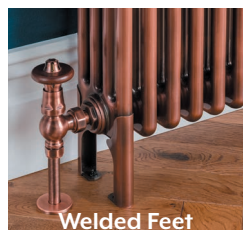

Welded Feet

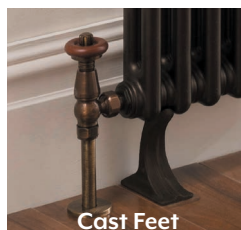

Cast Feet



Wall Brackets

## Service

Use our **online radiator builder** to select the best solution for your room. It will take you through the process quickly and easily and allows you to save your ideas to your own Wish List. Go to our NEW website [theradiatorcompany.co.uk](http://theradiatorcompany.co.uk)

### Valves

With Ancona you have a wide choice of valves to choose from, depending on your overall interior décor you could select our traditional valves, Vintage or the larger Vintage XL, available in a selection of traditional finishes. Or you might have a more modern scheme where the Ideal or Pistol range are better suited.

**Save £45 with our valve kit promotion, see product pages in the back of the brochure for full details or page 118.**



Vintage XL  
Antique Copper

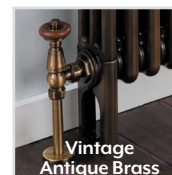

Vintage  
Antique Brass

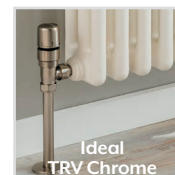

Ideal  
TRV Chrome

® Ancona is a registered trademark of IRSAP UK Limited

# Ancona® - Made to Order Finishes

The Ancona® made to order range is available in 188 RAL colours including our standard white RAL 9016, a bright porcelain white. As an alternative, RAL 9010 Pure White, a soft creamier white can be specified at the standard white price. We also offer 34 special finishes including Gun Metal Grey, Textured White and Ivory, Mottled, Metallics, Golds or Bare Metal Lacquer finishes. Our Galvanised finishes are available in a select range of set sizes. **Call 01342 302250 for a RAL chart and Special Finish chart.**



## 188 RAL Colours

Match your room style by selecting from a full rainbow of 188 RAL colours. Use either contrasting colours to create a bold statement or sympathetic colours so your Ancona® blends in to your wall.



## 34 Special Finishes including Bare Metal Lacquer and Galvanised

There are 34 classic colours to choose from including: metallics, mottled, textured effects, as well as bare metal lacquer and galvanised finishes, for a Special Finish chart please call our Customer Service team on **01342 302250**.



Textured Black Matt



Textured Stone



Mottled Silver



Gun Metal Grey



Mottled Copper



Pearl White



Black Sparkle



Bare Metal Lacquer



Galvanised  
Antique Copper



Galvanised  
Antique Brass

® Ancona is a registered trademark of IRSAP UK Limited

# Ancona<sup>®</sup> Made to Order

Welded Feet



4 column, 750mm x 926mm in Pearl Grey with Chrome Vintage TRVs



3 column, 1800mm x 476mm in Textured Stone with Nickel Vintage XL TRVs

# Ancona<sup>®</sup> Made to Order

Cast Feet



3 column, 1500mm x 566mm in Mottled Copper with Antique Copper Vintage TRVs



4 column, 300mm x 881mm in Textured White with Nickel Vintage TRVs

# Ancona<sup>®</sup> Made to Order

## Wall Brackets



3 column, 600mm x 701mm in Textured White with White Ideal TRVs





2 column, 2000mm x 476mm in Carbon with Nickel Vintage XL TRVs

A photograph of an Ancona Galvanised Antique Brass radiator in a room. The radiator is a three-column design with a dark, aged brass finish. It is positioned against a light-colored wall. To the left, a framed picture of a butterfly hangs on the wall. To the right, a modern tripod floor lamp with a brass shade and black legs stands near a window. The floor is made of dark wood planks. The radiator has two vintage-style TRVs (Thermostatic Radiator Valves) at the bottom, one on each side, with wooden knobs.

# Ancona® Galvanised

Antique Brass

3 column, 597mm x 611mm in Antique Brass finish with Antique Brass Vintage TRVs

# Ancona® Galvanised

## Antique Copper



Satin Nickel

3 column, 1897mm x 476mm in Antique Copper with Antique Copper Vintage XL TRVs

# Ancona<sup>®</sup> Bench Seat

Horizontal Made to Order



Horizontal, 6 column, 460mm x 1350mm in Mottled White Gold with Wooden Top and Chrome Pistol TRVs.

# Ancona<sup>®</sup> Bench Seat

Vertical Made to Order



Vertical, 5 column, 496mm x 1016mm in White RAL 9016 with Wooden Top and Nickel Vintage TRVs.

# Ancona® Curved

Made to Order



Internal curve with Welded Feet, 4 column, 500mm x 1376mm in Textured Ivory

# Ancona® Electric

Stock and Made to Order



3 Column 600mm x 843mm in White RAL 9016

# Contemporary Designer - Stock & Made to Order

Our contemporary designer range contains models that can be used throughout the home. Developed to reflect the latest trends in design these radiators will complement any interior scheme. The wide selection of sizes, formats and colour options allows you to select the perfect radiator to suit your heat output requirements, space and interior.

Knowing the heat output required (BTU/Watts) to heat your room is key when choosing your radiator. For help on calculating this and selecting the correct size of your chosen radiator please visit our website [theradiatorcompany.co.uk](http://theradiatorcompany.co.uk).

**All Stocked Designer Radiators are now delivered in 48-72 hours.**

## Design

*Prices from £315.00*

As Italy's leading manufacturer with over 50 years experience of innovative design, we offer the widest choice of stylish high quality radiators with guarantees ranging from 10 to 20 years.

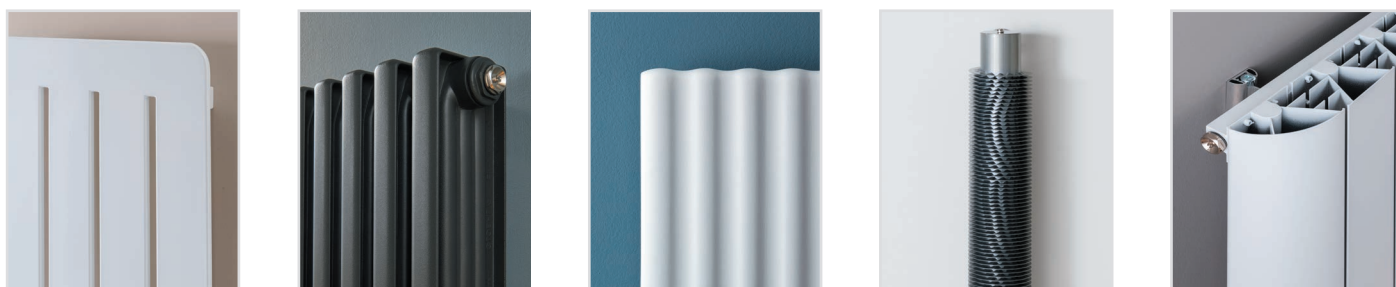

## Choice

### Aluminium

We have 4 exciting designer aluminium ranges, the Iseo, Niro, Sebino and Canto. All with the efficient features of aluminium and available in a range of sizes and colours for quick delivery. Plus we have the Odolo taking it's inspiration from traditional designs, the soft curves deliver a classic style.

Our Low Water Content radiators are designed for improved efficiency which contribute to reduced running costs while delivering great output.



For Low Water Content radiators look out for this symbol (shown left) in the technical section.



### Radiant Panels



Our Ceramica radiators are produced from what would have historically been a waste product of the production of marble worktops and tiles. This marble powder can now be fully recycled, bound together with water and eco-friendly adhesive agents and is compressed to form these high-quality products.

Made in Italy using a ground-breaking, patented technology, the use of low temperatures in the production process uses less energy and therefore has lower CO2 emissions, meaning it has a very low environmental impact. These radiators can be fully recycled, and have been designed to complement systems with renewable energy sources.

Unlike traditional radiators, the Ceramica range produces radiant heat. Compared to standard convection, radiant heat means less disturbance and distribution of dust particles, and an even and direct transfer of heat.



# Contemporary Designer - Stock & Made to Order

## Choice

### Mild Steel and Stainless Steel

There is an extensive choice of vertical, horizontal, single & double formats, as well as a variety of tube designs so you can have the right combination of design and heat output. In a range of material types such as mild and stainless steel, our designer radiators complement all types of interiors.



## Service

All our designer models with stock sizes are now available for delivery in 48-72 hours. Every stock size is listed in bold in the price tables. Made to order radiators available in 4-9 weeks.

Use our **online BTU (heat output) calculator** to get a guide of your room requirements which you can then check with your installer. Once you know your outputs use our **online radiator builder** to select the best solution for your room. It will take you through the process quickly and easily and allows you to save your ideas to your own Wish List. Go to our website [theradiatorcompany.co.uk](http://theradiatorcompany.co.uk)

### Painted Valves

You have the option to fully coordinate your designer radiator colour with your valves & pipe covers to create a unique & individual statement. *Note: valves & pipe covers must be ordered at the same time as the radiator.* See page 119 for full details.



Pistol TRV in Azurite with matching Pipe Covers & Shrouds

### Accessories

Make the most of your radiator by adding a towel bar or hanging peg. Great for kitchens, bathrooms and hallways these accessories can bring extra functionality to any radiator. See page 126 for full details.



**SAVE £45** WHEN YOU BUY OUR IDEAL TRV KIT WITH ANY DESIGNER ORDER\* QUOTE **PROMOVI** AT TIME OF ORDER (White or Chrome only, see product pages at the back of the brochure for full details)

\*Saving based on the value of individual items when bought separately.

Order any of our selected valves & matching pipe covers at the same time as your radiator; PROMOVIW (white), PROMOVIC (chrome).

## Finishes



**New Colour Coordination Service** for selected stock ranges, products that are available for this service will have the Colour Coordination icon (shown left) on their individual technical pages. Please see pages 6-7 for full details and how to order.

### 188 RAL Colours (made to order)

Match your room style by selecting from a full rainbow of 188 RAL colours. Use either contrasting colours to create a bold statement or sympathetic colours so your designer radiator blends into your wall. For a RAL chart please call **01342 302250**.



### 30 Special Finishes (made to order)

A choice of metallics, mottled and textured effects. For a Special Finish chart please call our Customer Service team on **01342 302250**.



Mottled Silver

Mottled Copper

Carbon

Sienna Brown

Sunstone

Ancient Bronze

Grey Sparkle

Gun Metal Grey

Azurite

Black Sparkle

Textured Black Matt

# Ceramica Collection

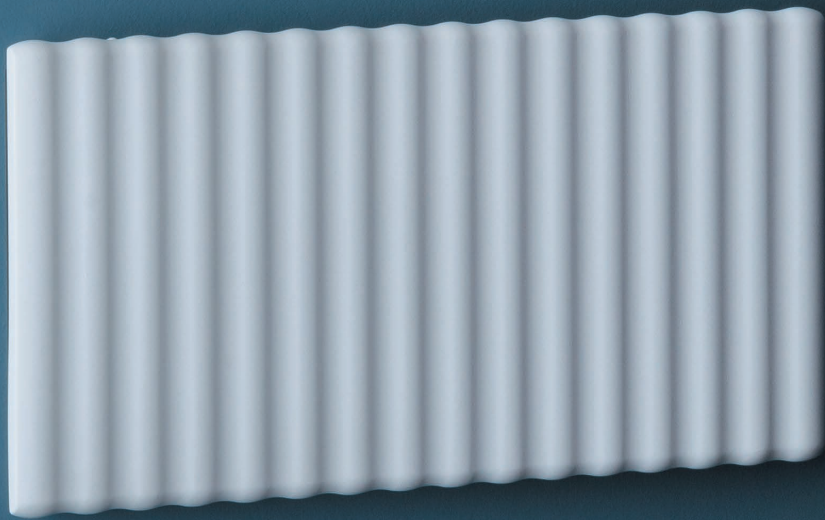

Senso Model



Varena Model 550mm x 1100mm with integrated valves



Pavia Model 1800mm x 300mm with integrated valves

Torré



Horizontal 600mm x 956mm in Textured Matt White RAL 9016 with White Ideal TRVs



Vertical 1800mm x 356mm in special finish RAL 9007 Grey Aluminium with Chrome Corner Ideal TRVs

# Niro



Horizontal 631mm x 799mm in White RAL 9016 with White Corner Ideal TRVs



Vertical 1831mm x 479mm in RAL 7016 with Nickel Ideal TRVs

Iseo



Horizontal 500mm x 1185mm in White RAL 9016 with White Ideal TRVs





Vertical 1800mm x 335mm in RAL 7016 with matching painted Pistol TRVs

# Sebino



Horizontal 634mm x 820mm in White RAL 9010



New Matt Silver finish

Vertical 1834mm x 500mm in White RAL 9010 with White Corner Ideal TRVs

# Odolo



649mm x 1024mm in White RAL 9010 shown with White Ideal TRVs



1849mm x 524mm in White RAL 9010 shown with White Ideal TRVs

# Canto



668mm x 1020mm in RAL 7016 shown with Nickel Ideal TRVs.

# Ellipsis Stainless Steel



Double 1800mm x 413 in Polished Stainless Steel with Chrome Corner Ideal TRVs

# Ellipsis



Double horizontal 600mm x 1020mm in RAL 7016 with Nickel Corner Ideal TRVs





Single vertical 1820mm x 480mm shown in White RAL 9016 with Chrome Ideal TRVs

# Sitar



Double horizontal 504mm x 1220mm in White RAL 9016 with White Ideal TRVs.



Single horizontal

Double vertical 1820mm x 402mm shown in RAL 9007 with Nickel Ideal TRVs.

# Sax



Double horizontal 520mm x 900mm shown in RAL 9016 with White Ideal TRVs



Double vertical 1800mm x 400mm shown in RAL 9006 White Aluminium with Chrome Pistol TRVs

# Piano



Double horizontal 456mm x 1220mm in Black Sparkle with Chrome Corner Ideal TRVs



Double vertical 1820mm x 456mm in White RAL 9016 with Ideal TRVs

# Water Lily



Single 2020mm x 312mm in Matt Black with Nickel Corner Ideal TRVs



Immagina



LED Version 1800mm x 500mm shown in Black RAL 9005

# Athena



Horizontal 410mm x 1200mm in RAL 8019 with Nickel Corner Ideal TRVs



Vertical 1800mm x 410mm in White RAL 9016 with White Corner Ideal TRVs

# Relax



Double horizontal 578mm x 1401mm shown in RAL 9007 with Nickel Corner Ideal TRVs



Inox single vertical

Single vertical 1853mm x 381mm in White RAL 9016 with White Corner Ideal TRVs

# Halo



Horizontal 133 diameter x 2000 in Matt Black 9005



Vertical 1800mm x 155mm diameter, shown in Metallic Silver with Pistol TRVs.

# Sectional Aluminium - Stock

Smooth, clean lines and slim profiles make these ranges perfect for both new homes and as replacement radiators. Their practical functionality makes them suitable for living rooms, bedrooms, or studies and our variety of accessories can also enhance their use in kitchens, bathrooms, and hallways.

Use our online radiator builder to help select the best configuration for your room; [theradiatorcompany.co.uk](http://theradiatorcompany.co.uk).

Sectional Aluminium is available in;

- **White RAL 9010 in 48-72 hours**
- **23 RAL and 30 special finishes available in up to 3 weeks.**

## Design

Prices from **£250.00**

Energy Efficient & Made from Recycled Materials



Low water content

- An aluminium radiator will heat up in just over half the time of a steel radiator and use 50% less water, saving money by using less fuel. This makes aluminium among the **most energy-efficient radiators available**.
- As aluminium radiators are a third lighter than steel radiators, it means they are extremely light and easy to install on any type of wall.
- Aluminium radiators are excellent heat conductors; our products have high thermal efficiency and contain a lower amount of water, therefore heating up faster than those produced with other materials. They are therefore easier to control & cost much less to run.

With modern building methods and regulations requiring more insulation and higher U values for windows, having a more efficient heating system that can react quickly to changes in temperature and that can produce enough heat from smaller heat emitters means a more comfortable living environment and cheaper utility bills.

All our Sectional Aluminium radiators are made in Italy and are available in 4 different profiles.



Vox



Mix



Vip with optional end panels

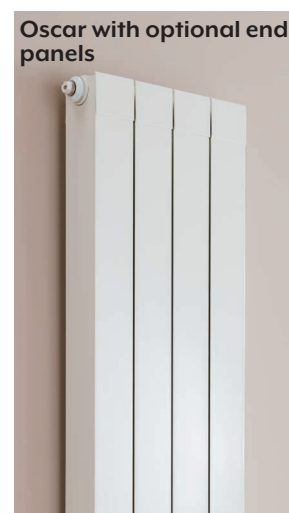

Oscar with optional end panels

## Choice

Our Sectional Aluminium ranges boast incredible versatility with hundreds of possible size options all available from stock. Meet your size requirements with 3 to 20 sections, finished in a choice of 23 RAL colours (shown on page 197) and 30 special finishes (shown right).

See our online radiator builder for more information; [theradiatorcompany.co.uk](http://theradiatorcompany.co.uk).



# Sectional Aluminium - Stock

## Service

White models available from stock in 48-72 hours delivery

**23 RAL colours & 30 special finishes available in up to 3 weeks** (Please allow an extra 10 working days for orders of more than 10 radiators).

Use our **online BTU (heat output) calculator** to get a guide of your room requirements which you can then check with your installer. Once you know your outputs use our **online radiator builder** to select the best solution for your room. It will take you through the process quickly and easily and allows you to save your ideas to your own Wish List. Go to our website **theradiatorcompany.co.uk**

See our Assembled options for our most popular sizes, other sizes can be made to your specification using the sectional data.

Please note; delivery lead times on coloured aluminium start from when we have receipt of your chosen RAL colour number and description in writing. Please ensure the selected RAL colour number and name is included on your order to avoid potential delays.

### Painted Valves

You now have the option to fully coordinate your aluminium radiator colour with your valves and pipe covers to create a unique and individual statement. Image right is a Mix in Azurite with matching Pistol TRV, pipe covers & shrouds. **Note: valves & pipe covers must be ordered at the same time as the radiator.** See page 119 for full details.



### Aluminium Accessories

Aluminium accessories include hanging pegs, towel bars and for the Oscar and Vip, end panels to create a clean side profile, see page 177 for more details.



**SAVE £45** WHEN YOU BUY OUR **IDEAL TRV KIT** WITH ANY ALUMINIUM ORDER\* QUOTE **PROMOVI** AT TIME OF ORDER (White or Chrome only, see product pages in the back of the brochure for full details)

\*Saving based on the value of individual items when bought separately. Order any of our selected valves & matching pipe covers at the same time as your radiator; PROMOVIW (white), PROMOVIC (chrome).

## Finishes

White RAL 9010 delivered in 48-72 hours



### New Colour Coordinating Service

Available for all sectional aluminium, see product pages 6-7 for full details including process & lead times.

### 23 RAL Colours

All our Sectional Aluminium radiators are available in a selection of the 23 most popular colours from the RAL range (shades of White, Cream, Grey, Brown, Red & Black), on page 197. Available in up to 3 weeks.

Please call 01342 302250 for a RAL chart.



### Special Finish Options

Our aluminium ranges are also available in 30 exclusive special finishes (some of which are shown below), combining the efficiency of aluminium with a truly stunning finish. Available in up to 3 weeks. **Please call 01342 302250 for a Special Finish chart.**



Mottled Silver Mottled Copper Carbon Sienna Brown Sunstone Ancient Bronze Grey Sparkle Gun Metal Grey Azurite Black Sparkle Textured Black Matt

For orders of more than 10 radiators in colour or special finishes please allow an extra 10 working days for delivery.

Vip



590mm x 1060mm in White RAL 9010 shown with White Pistol TRVs



790mm x 820mm in Grey Sparkle shown with Nickel Pistol TRVs

# Oscar



1646mm x 420mm colour coordinated in Dulux Natural Slate shown with optional matching end panels and matching Pistol TRVs



1846mm x 340mm in White RAL 9010 shown with White Ideal TRVs

Vox



590mm x 740mm in White RAL 9010 with White Ideal TRVs



1846mm x 340mm in RAL 9006 White Aluminium with Nickel Corner Ideal TRVs

Mix



440mm x 1060mm in Azurite with Nickel Corner Ideal TRVs





690mm x 1060mm in RAL 9010 with White Pistol TRVs

# Traditional Cast Iron - Stock & Made to Order

The epitome of traditional heating, cast iron radiators are a must for any period restoration; suitable for living rooms, bedrooms, kitchens, hallways and dining rooms. Our choice of six classic designs offer the clean simplicity of “column” or the “decorative classic”. These radiators will be a perfect match for any existing radiators and being new, they come with a ten year guarantee.

## Design

Prices from £162.00

As a material, cast iron has its own unique properties; these radiators will hold their heat for a long time, compared to a similar steel model, although they are slower to heat up and therefore less responsive to sudden changes in temperature.

### Column

Probably the most well-known form of cast iron radiators, the original imported column models bring a real charm and character to any period property.



Ledbury



Aston



Telford

### Decorative Classic

The intricate and detailed designs of the Trieste and Bohemia with their tasteful scrollwork, bring a touch of splendour to your home. Our Linton range reflects the style of the 1920s, with smooth clean lines and a choice of exclusive galvanised and painted finishes.



Bohemia



Linton



Trieste

## Choice

### Sectional

Our sectional cast iron range is incredibly versatile with literally hundreds of possible sizes from a wide range of column depths & heights finished to your size. Use our **online radiator builder** to select the best solution for your room on our website [theradiatorcompany.co.uk](http://theradiatorcompany.co.uk).

### Mounting Options

Cast iron radiators are very heavy and therefore best mounted with floor supports. All of our ranges are available with Footed Ends as standard. The Telford & Ledbury have selected sizes without footed ends which can be sold with optional Cast Feet.



Footed End Sections



Cast Foot

### Solid Brass Wall Ties & Airvents New

Available to buy with all of our cast iron radiators, see page 189 for details.



## Service

All stocked cast iron lines are listed in bold in the technical section, primer finish delivered in 5-7 working days.

Use our **online radiator builder** to select the best solution for your room. It will take you through the process quickly and easily and allows you to save your ideas to your own Wish List. Go to our website [theradiatorcompany.co.uk](http://theradiatorcompany.co.uk)

Our range of valves include the classically styled Vintage TRV, Vintage XL TRV as well as the Black & Brass TRVs.



**SAVE £45**

WHEN YOU BUY OUR **VINTAGE TRV KIT** WITH ANY CAST IRON ORDER\* QUOTE **PROMOV2** AT TIME OF ORDER  
(For all Vintage TRV finishes, please see product pages in the back of the brochure for full details)

\*Saving based on the value of individual items when bought separately. Order any of our selected valves & matching pipe covers at the same time as your radiator.

# Cast Iron Finishes

Our range of Cast Iron radiators are available in a wide choice of finishes. We offer a choice of colour ranges and levels of finishing for you to select from. Please note; that as a result of the casting process, cast iron radiators have a rough surface finish with small imperfections which will show after the painting process.



## RAL Colours

A range of 24 of the most popular colours from the RAL range. We use a robust, polyester powder coat paint, which is applied by our specialist UK based painters, to achieve a long-lasting, durable finish. Visit page 197 for full list of RAL colours and please call **01342 302250** for a RAL chart.

*Please Note; delivery lead times on coloured cast iron start from when we have receipt of your chosen RAL colour number / special finish in writing; please ensure the selected RAL colour number / special finish and name is included on your order.*

## Primer Finish

Our standard finish is primer, which requires finishing to prevent rust from forming. If carried out by hand this can be a long and difficult process as cast iron is very heavy and the entire surface must be covered with an appropriate undercoat and topcoats for full protection.



Mottled Bronze

Gun Metal Grey

Textured Stone

Mottled Copper

## Special Finishes

We can also overpaint your Ledbury, Trieste or Telford cast iron radiator in any of the special finishes in our Special finish chart including metallics, mottled & textured effects (excludes Mottled White Gold). For a Special Finish chart please call our Customer Service team on **01342 302250**.

## Colour Coordination Service

In addition to the finishes listed above and below, we can also arrange for selected stocked models to be painted to reflect the colours of the most popular and premium paint brands. We can take your chosen colour and create a highly durable powder coat finish that will allow your radiator to blend in with your wall colour (or stand out if you want to make a statement!). Available for the Ledbury, Telford, and Trieste cast iron ranges only, please turn to pages 6-7 for full details.



Aston Polished

## Polished

Our Aston and Linton radiators are available in a beautiful high lustre, polished finish. Created by hand, an initial black paint is used to protect hidden, hard to access areas of the radiator and to highlight the visible polished areas. The front, sides and tops of the sections are polished whilst the rear and more difficult to access areas between the sections remain black. A series of burnishing & polishing processes produces the final stunning results.

## Linton / Bohemia Special & Galvanised Finishes

The Linton and Bohemia cast iron models are available in our 24 RAL colours, 4 special finishes exclusive to the range and a galvanised copper finish.

We can also Burnish both models and the Linton can be given a high lustre Polish (please see page shown 192 for the Linton & 195 for the Bohemia).

Please note, due to the printing process, these colours may not be representative of the true finished colour.



Galvanised Copper

Burnished

Soft Gold

# Ledbury



Mini 4 column, 475mm x 1048mm in RAL 7016 with footed end sections and Nickel Vintage TRVs



New Colour Coordinating service

6 Column, 665mm x 628mm in Matt White with Antique Brass Vintage XL TRVs

Aston



3 column, 860mm x 610mm in RAL 7044 Silk Grey with Chrome Vintage XL TRVs



Polished finish

4 column, 760mm x 493mm in White RAL 9010 with Chrome Vintage TRVs

# Telford



6 column, 280mm x 990mm shown in Mottled Copper with cast feet & Antique Copper Vintage TRVs





2 column 1035mm x 690mm in White RAL 9010 with footed ends and Chrome Vintage TRVs.

# Linton



3 Column, 621mm x 1098mm in Polished with Nickel Vintage XL TRV valves



2 Column, 921mm x 442mm in Antique Brass with Antique Brass Vintage XL TRV valves

# Trieste



Mini 2 Column, 514mm x 1088mm in Ancient Bronze with Antique Brass Vintage XL TRVs



3 Column, 961mm x 804mm in Matt White with Antique Brass Vintage XL TRVs

# Bohemia



720mm x 688mm in Burnished with Nickel Vintage XL TRVs

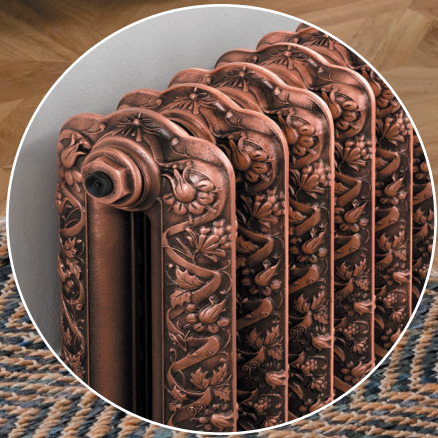

Galvanised Copper

720mm x 688mm in RAL 9010 with Nickel Vintage XL TRV valves

# Towel Rails - Stock and Made to Order

With space often at a premium, a towel rail functions as both a heat source and as a towel warmer; perfect for bathrooms, kitchens and cloakrooms.

Look out for our stocked Towel Rails delivered in 48-72 hours.

## Design

Prices from £141.00

As Italy's leading manufacturer with over 50 years experience, we offer the widest choice of stylish high-quality towel rails with guarantees ranging from 10 to 20 years.

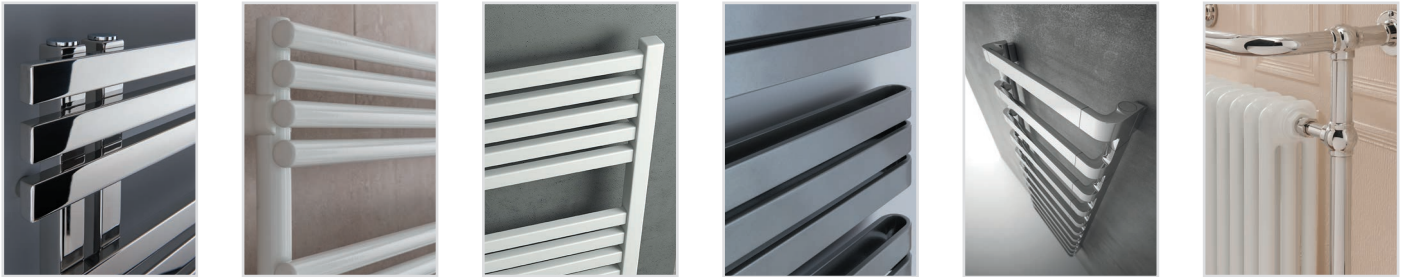

## Choice

An extensive choice of styles, from standard vertical formats to horizontal and side loading towel rails. We offer a wide variety of tube styles, including round, flat, oval, and rectangular in a range of materials; mild steel, stainless steel, and brass for the more traditional style.

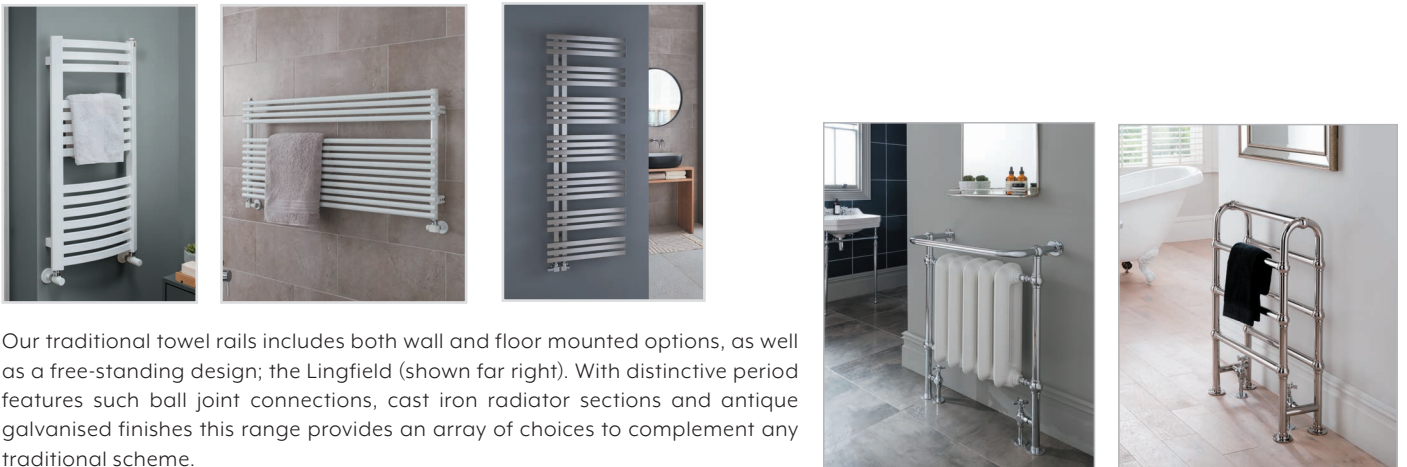

Our traditional towel rails includes both wall and floor mounted options, as well as a free-standing design; the Lingfield (shown far right). With distinctive period features such as ball joint connections, cast iron radiator sections and antique galvanised finishes this range provides an array of choices to complement any traditional scheme.

## Service

Look out for our Towel Rails which now have stock lines available for delivery in 48-72 hours; all stock lines are shown in bold in a separate 'stock' table in the technical section.

### Painted Valves

You have the option to fully coordinate your towel rail colour with your valves and pipe covers to create a unique and individual statement. Picture right shows a Lupin ladder rail in RAL 7016 with matching Cylinder valves and pipe covers and shrouds. See page 119 for full details.



**SAVE £45** WHEN YOU BUY OUR **CYLINDER VALVE KIT** WITH ANY TOWEL RAIL ORDER\*, PLEASE QUOTE **PROMOV3** AT TIME OF ORDER (White or Chrome only, see product pages in the back of the brochure for full details)

\*Saving based on the value of individual items when bought separately.  
Order any of our selected valves & matching pipe covers at the same time as your radiator; PROMOV3W (white), PROMOV3C (chrome).



# Towel Rails - Stock and Made to Order

## Electric and Dual Fuel Towel Rails



### Electric

Fully electric self-contained units that are powered by mains electricity, they can be supplied with a variety of elements, some that have complete temperature and timing options built-in, some that are basic on-off options that can be controlled by an additional control panel. These standalone towel rails allow you to install a towel rail without the need for any new pipework and can be used independently of your heating system.



Purple 'electric' symbol denotes which towel rails have fully electric models.



### Dual Fuel

Most towel rails are installed as part of a standard central heating system, but this means they will be cold when the heating is turned off in summer. With a dual fuel option, you can have the best of both worlds. Using a special valve connection, you can add an electric element to your towel rail that allows you to use your towel rail and warm your towels in the summer without having to turn on your heating.



Towel rails that can be converted will have this blue dual fuel symbol on their respective pages

Please turn to pages 116-117 for more detailed information and prices.



## Finishes

Popular stock sizes in White RAL 9016 or Chrome are available for delivery in 48-72 hours

### 188 RAL Colours

Match your bathroom, kitchen, or cloakroom style by selecting from a full rainbow of 188 RAL colours. Use either contrasting colours to create a bold statement or sympathetic colours so your Towel Rail blends into your wall. For a RAL chart please call **01342 302250**.



### 30 Special Finishes

A choice of metallics, mottled and textured effects. For a Special Finish chart please call our Customer Service team on **01342 302250**.



For orders of more than 10 radiators in colour or special finishes please allow an extra 10 working days for delivery.

# Step BDO



BDO Step 430mm x 1500mm shown in White Pearl

Step



Step Electric in Chrome

Step 1240mm x 500mm shown in Chrome

# Athena BDO



455mm x 1200mm in RAL 7040 shown with Nickel Cylinder valves.

# Athena Towel Rail



1600mm x 500mm in White RAL 9016 shown with White 3 Style Corner valves.

# Relax Bagno



1853mm x 517mm in Polished Stainless Steel with Corner Ideal TRV valves

# Echo



1695mm x 600mm in White RAL 9016 with White Cylinder valves

# Piano Towel Rail



Dual Fuel options see pages 116-117



1520mm x 506mm in RAL 9006 with Chrome 3 Style Corner valves



# Piano Lato



1260mm x 550mm in White RAL 9016 with White Cylinder valves

Dual Fuel options see pages 116-117

# Quadre



1216mm x 430mm in Matt Black with Chrome Mini Cube valves

# Griffin



Dual Fuel options see pages 116-117

1220mm x 400mm in RAL 7012 with Nickel Cylinder Valves

# Pulsar



Dual Fuel options see pages 116-117

1224mm x 500mm in Platinum with Nickel Mini Cube valves

# Ellipsis Towel Rail



1380mm x 400mm shown in Platinum with Nickel Ideal TRVs.

# Sitar Lato



Dual Fuel options see pages 116-117

1348mm x 500mm in RAL 9007 with Nickel Cylinder valves

# Sitar BDO



543mm x 1220mm in White with White 3 Style Corner valves

# Poll BDO



660mm x 1200mm in RAL 9016 with White Cylinder valves



# Poll



Dual Fuel options see pages 116-117

1480mm x 600mm shown in RAL 9016 with 3 Style Corner valves.

# Poppy

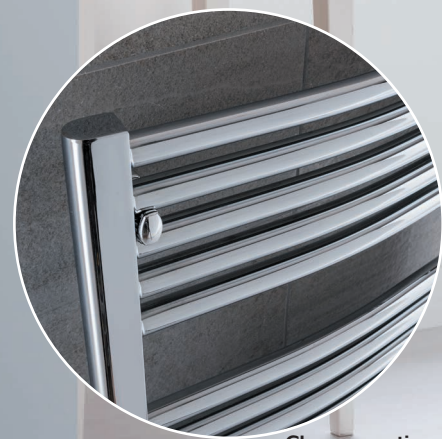

Chrome option

White 1497mm x 598mm with White Cylinder valves



Dual Fuel options see pages 116-117

RAL 9005 1497mm x 398mm with Chrome 3 Style Corner valves

# Lupin



Electric Chrome option

1210mm x 600mm in Chrome with Chrome 3 Style valves



Dual Fuel options see pages 116-117

1497mm x 500mm in RAL 9007 with Nickel Cylinder valves

# Iris

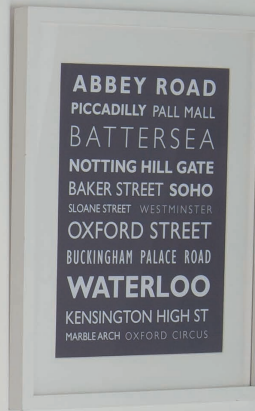

Dual Fuel options see pages 116-117

600mm x 1000mm with Chrome 3 Style Corner valves



1200mm x 500mm shown with Chrome 3 Style Corner valves

# Blues



1400mm x 500mm in Polished Stainless Steel with 3 Style valves



# Chalfont Range

Floor Standing



Wall Hung



750mm x 500mm in Chrome

Floor Standing 938mm x 675mm in Chrome

# Lingfield



850mm x 600mm in Chrome with Chrome Crosshead valves

# Linton Towel Rail



**New** RAL colours available for cast iron sections

900mm x 490mm with White RAL 9016 cast iron sections and Chrome Crosshead valves

# Heating Elements & Dual Fuel Kits

All available from stock and delivered in 48-72 hours.

Heating elements are used as a heat source in electric radiators, towel rails and dual fuel towel rails. You can easily install your radiator or towel rail as dual fuel by connecting it to your central heating system along with a heating element, meaning you are able to run your product as electric in the summer months.

All towel rails that can be converted to dual fuel will have a dual fuel symbol in the technical section



Follow these simple stages to select the correct Dual Fuel Kit for your towel rail.

## 1. Valve Configurations

All radiators will require a valve, select either a T-piece or a Dual Fuel valve to suit your installation.

## 2. Types of Element

There are four types of electric elements to choose from (see below and opposite).

## 3. How to choose your Element

It is important to select the correct size element for your towel rail. Too small and it will not provide enough heat, too large and it can burn out. The chart above right that shows the towel rail output in watts and the corresponding recommended size of element.

Towel Rail output range in Watts	Electric Elements
165 - 255	200w
260 - 375	300w
380 - 530	400w
535 - 735	600w
740 - 920	800w
920 - 1100	1000w

## Round Bluetooth Element Bluetooth

- 5 heat settings from 30°C to 60°C regulating the internal radiator temperature, denoted by 5 LED's
- Full operational control of the element on smartphone / tablet via Bluetooth (with "Terma BLUE-Line" App: iOS / Android)
- Provides a choice of internal temperature (30°C to 60°C) or ambient room temperature (15°C to 30°C) regulation.
- 7 day timer. 2 hour drying function
- Lot20 EcoDesign Directive compliant\*
- Guarantee - 2 years
- Delivered in 48-72 hours



Description	Model	Output	IP Rating	Black Ex VAT	Black Inc VAT	Silver Ex VAT	Silver Inc VAT
Round Bluetooth Element	AARBELE	120, 200, 300, 400, 600, 800, 1000 & 1200 watts	IPx5	£166.00	£199.20	£166.00	£199.20

\*Lot 20 EcoDesign Directive Compliancy - The Round & Square Bluetooth Elements (or any element fitted with the Wi-Fi Timer device) are all compliant with Lot 20; whereby an electric room radiator (does not apply to electric towel rails) has to have a weekly timer and adaptive start control/out of home control.

## Low Temperature 43D Element

- Element pre-programmed to run at an internal temperature of 43°C, for Low Surface Temperature (LST) style operation\*
- When specifying this element, to help ensure correct surface temperature, reduce the output of your radiator (as water) by 40% (i.e for a 200w towel rail install the 120w element)
- No Timer. 2 hour drying function
- Frost & overheating protection
- IPx5. Class I.
- Guarantee - 2 years
- Delivered in 48-72 hours



Description	Model	Output	IP Rating	Silver Ex VAT	Silver Inc VAT
Low Temperature 43D Element	LT43ELE	120, 200, 300, 400, 600 & 1000 watts	IPx5	£142.00	£170.40

\*Note: Small areas of the towel rail could exceed 43° by a marginal amount during the initial heating up process

## Cable Masking Cover (for Round Bluetooth & Low Temperature elements only)



Delivered in 48-72 hours

Description	Suitable for	Model	White Ex VAT	White Inc VAT	Black Ex VAT	Black Inc VAT	Silver Ex VAT	Silver Inc VAT	Chrome Ex VAT	Chrome Inc VAT
Element Masking Cover	AARBELE & LT43ELE Models	AAMASK	£9.00	£10.80	£9.00	£10.80	£9.00	£10.80	£9.00	£10.80

# Heating Elements & Dual Fuel Kits

All available from stock and delivered in 48-72 hours.

## Digital Square Element

- 30 Heat settings from 30°C to 60°C in steps of 1°C. Regulates the internal temperature and displays this on screen.
- Daily 24hr timer. 0.5 to 4hr drying function.
- 4x Buttons: Dryer, Power, Temp +/-.
- Frost & overheating protection.
- IPx5. Class 1. Guarantee - 2 years
- Delivered in 48-72 hours



Chrome + Grey Cable



White + White Cable

Description	Model	Output	IP Rating	White Ex VAT	White Inc VAT	Chrome Ex VAT	Chrome Inc VAT
Digital Square Element	AADSELE	120, 200, 300, 400, 600 & 1000 watts	IPx5	£150.00	£180.00	£168.00	£201.60

## Square Bluetooth Element Bluetooth®

- Full operational control of the element on smartphone/tablet via Bluetooth (with "Terma BLUE-Line" App: IOS/ANDROID).
- Provides a choice of internal temp (30°C to 60°C) or ambient room temp (15°C to 30°C) regulation.
- 7 day timer. 1-4hr drying function.
- Lot20 EcoDesign Directive compliant\*
- Frost & overheating protection.
- IPx5. Class 1. Guarantee - 2 years
- Delivered in 48-72 hours



Chrome + Grey Cable



White + White Cable



Black + Black Cable



Silver + Grey Cable

Description	Model	Output	IP Rating	White Ex VAT	White Inc VAT	Black / Silver Ex VAT	Black / Silver Inc VAT	Chrome Ex VAT	Chrome Inc VAT
Square Bluetooth Element	AASBELE	120, 200, 300, 400, 600, 800 & 1000 watts	IPx5	£203.00	£243.60	£212.00	£254.40	£220.00	£264.00

## Corner TRV Valve for Dual Fuel

- This valve is ideal for dual fuel as it incorporates a TRV, Lockshield with an integrated T Piece, to accommodate the element.
- Valve colour: Chrome
- Delivered in 48-72 hours



Image shows left hand option

Description	Model	Chrome Ex VAT	Chrome Inc VAT
Dual Fuel TRV Valve - Right Hand	VVDFTRVRH	£212.00	£254.40
Dual Fuel TRV Valve - Left Hand	VVDFTRVLH		

## T-Piece (for Dual Fuel)

- A T Piece is required for Dual Fuel installation as it allows both an element and a valve to be fitted to the same tapping on a radiator.
- We offer one type of valve where no T Piece is required (detailed above). Or you can source your own standard pair of valves to fit along with this T Piece.
- Delivered in 48-72 hours



White



Chrome



Matt Black



Matt Silver

Description	Model	Price Ex VAT	Price Inc VAT
White T-Piece (for Dual Fuel)	AATPIECEW	£11.00	£13.20
Matt Black T-Piece (for Dual Fuel)	AATPIECEB	£11.00	£13.20
Matt Silver T-Piece (for Dual Fuel)	AATPIECES	£11.00	£13.20
Chrome T-Piece (for Dual Fuel)	AATPIECEC	£13.00	£15.60

## Fused Spur with Programmer

- Combination fused spur & 7 day timer in one. Fully controllable from anywhere in the world via free app (ANDROID & IOS).
- 40mm projection. Fits over standard flush or surface mount back box - 32mm deep.
- 3kw load capacity.
- Non IP Rated - install outside bathroom.



Description	Model	Price Ex VAT	Price Inc VAT
Fused Spur and Wi-Fi Timer Combination Device	AAFSWTIMER	£144.00	£172.80

Delivered in 48-72 hours

# Valves

Every Radiator needs a pair of valves to operate. A good quality valve not only benefits from efficient performance they also add to the appearance of your finished radiator. All our valves have a 5 year warranty and can be delivered within 48-72 hours.

## Wheelhead and Lockshield;

Every Radiator requires a pair of valves that work together, the Wheelhead adjusts the flow of water into the radiator and the Lockshield balances the flow of water around the whole system, ensuring each radiator heats up at the same rate, these should be adjusted by your installer.

## TRV or Manual?

Thermostatic Radiator Valves (TRVs) monitor the room temperature. They usually have between 4 to 6 levels and the valve opens and closes automatically to reach and maintain the desired level. TRVs can help maximise the efficiency of your system reducing energy consumption and are now a requirement as part of building regulations relating to new builds and refurbishments. Manual valves are adjusted by hand; they allow a constant flow of water through your radiator regardless of the room temperature and radiators will only turn off when the main thermostat reaches its set point or the programmer turns the heating off.

## Angled, Corner or Straight?



## Pipework and Pipe centres;

All our valves have 15mm connections as standard unless otherwise stated; if you need different connections please specify when ordering your valves. The use of plastic pipe has become more popular; however, our valves are not designed to operate with plastic pipes. Also, if chrome pipework is used most valves will not grip it securely because chrome is a harder surface than copper or iron and leaks can occur. Special fittings are required to enable valves to grip chrome pipe work and these must be specified at time of order. The position of the pipework for your radiator will be affected by the valves you select. All angled valves have a dimension to allow for adjusting pipe work. You should make adequate allowances for manufacturing tolerances in pipe centres. For straight valves, a minimum of 150mm should be allowed from the base of the radiator for ease of installation.

**Please note: We will always supply angled valves as standard, if you require straight please specify at time of order. We endeavour to ensure all pipe centres are correct, however manufacturing tolerances must be considered; we strongly recommend that pipe work is not altered or adjusted until the new radiator or towel rail is fitted. The Radiator Company will not accept any responsibility for claims resulting from incorrect pipe centres.**

# Valve Kit Offer

## SAVE MONEY

WHEN YOU BUY OUR SELECTED VALVE KIT'S WITH ANY RADIATOR ORDER\*  
(see product pages in the back of the brochure for full details)

### IDEAL TRV (white / chrome)



Please quote **PROMOV1**  
(specifying 'W' for white or 'C' chrome)

### VINTAGE TRV (any finish)



Please quote **PROMOV2**  
(please specify your finish at time of order)

### CYLINDER VALVE (white / chrome)



Please quote **PROMOV3**  
(specifying 'W' for white or 'C' chrome)

\*Saving based on the value of individual items when bought separately. Order any of our selected valves & matching pipe covers at the same time as your radiator quoting the relevant promo code.

# Painted Valves

Create a unique and individual statement with your valves and pipe covers. The valves pictured below can be painted in the same colour as your radiator from one of our 23 RAL colours shown on page 197, 30 Special Finishes and "Feature Finishes" from the Ancona® range.

Pictured right is a Lupin Towel Rail in RAL 7016 with matching painted Cylinder valves and pipe covers and shrouds.

Painted valves are delivered in up to 3 weeks.

*Note: Painted valves & pipe covers can only be ordered in the same colour and at the same time you order your painted radiator and can not be purchased separately.*



To provide complete coordination, simply follow these three easy steps:

## 1. Select your valve;

Pistol TRV (shown in Azurite)



Description	Model	Colour Ex VAT	Colour Inc VAT
DELIVERY TIMES		UP TO 3 WEEKS	
Angled or Straight	VVPISLTRV	£307.00	£368.40

Cylinder (shown in RAL 7016)



Description	Model	Colour Ex VAT	Colour Inc VAT
DELIVERY TIMES		UP TO 3 WEEKS	
Angled or Straight	VVCYL	£213.00	£255.60

Crosshead (shown in Mottled Copper)



Description	Model	Colour Ex VAT	Colour Inc VAT
DELIVERY TIMES		UP TO 3 WEEKS	
Angled or Straight	VVCRO	£302.00	£362.40

## 2. Select your colour from a choice of 23 RAL colours and 30 special finishes

There are 23 RAL colours and 30 special finishes to choose from including metallics, mottled and textured effects. For a RAL or Special Finish chart please call our Customer Service team on 01342 302250.



Copper

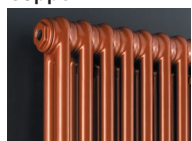

Textured Anthracite



Pearl Bronze



Available when purchasing Ancona® Feature Finishes only (see pages 12-13 & 130-135)  
Please call **01342 302250** for sample swatches

## 3. Select matching pipe covers and shrouds.

We can also match the colour of the pipe covers and pipe shrouds for your radiators or towel rails in any one of the colour options shown above. Each pair of painted pipe covers comes with matching shrouds.



Azurite



Mottled Copper



Textured Black Matt



Platinum

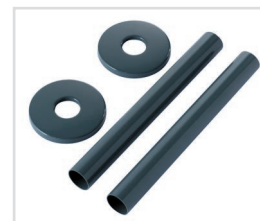

RAL 7016

Description	Model	Colour Ex VAT	Colour Inc VAT
DELIVERY TIMES		UP TO 3 WEEKS	
Pipe Covers (Pair)	AAPIPECOVR	£145.00	£174.00

Each set is supplied with 2 x 160mm pipe covers & 2 shrouds. Delivery on coloured pipe covers is up to 3 weeks.

# TRV Valves

Stocked valves are listed in bold & will be delivered in 48-72 hours.

## Corner Ideal TRV shown on pages 12, 37, 48 & 54

Available in six finishes  
Delivered in 48-72 hours.



Chrome Wheelhead & Lockshield



Chrome Corner Ideal TRV on Ancona\*

<b>Pipe Centers</b> For corner valves allow an extra 90mm in total	<b>Valve Height</b> 116mm	<b>Please Note</b> Corner Ideal TRV valves are not Bi-directional
---	------------------------------	--



Antique Brass



White



Black



Nickel



Antique Copper

Description	Model	Chrome Ex VAT	Chrome Inc VAT	White Ex VAT	White Inc VAT	Nickel Ex VAT	Nickel Inc VAT	Black Ex VAT	Black Inc VAT	Antique Copper Ex VAT	Antique Copper Inc VAT	Antique Brass Ex VAT	Antique Brass Inc VAT
Corner only	VVCOIDTRV	<b>£165.00</b>	<b>£198.00</b>	<b>£165.00</b>	<b>£198.00</b>	<b>£230.00</b>	<b>£276.00</b>	<b>£230.00</b>	<b>£276.00</b>	<b>£230.00</b>	<b>£276.00</b>	<b>£230.00</b>	<b>£276.00</b>



# TRV Valves

Stocked valves are listed in bold & will be delivered in 48-72 hours.

## Ideal TRV shown on pages 13, 36, 45 & 55.

Available in six finishes, in angled or straight options, the Ideal TRV is a great value Thermostatic valve. Delivered in 48-72 hours.



Straight Nickel



Nickel Angled Ideal TRV on Ancona\*

Pipe Centers For angled valves allow an extra 80mm in total	Valve Height 125mm	Please Note Ideal TRV valves are not Bi-directional
--	-----------------------	--



Chrome



Antique Brass



Antique Copper



Black



White

Please note:

All valves are sold in pairs, a lockshield and a wheelhead. Angled will be supplied as standard, please specify if you require straight valves.

Description	Model	Chrome Ex VAT	Chrome Inc VAT	White Ex VAT	White Inc VAT	Nickel Ex VAT	Nickel Inc VAT	Black Ex VAT	Black Inc VAT	Antique Copper Ex VAT	Antique Copper Inc VAT	Antique Brass Ex VAT	Antique Brass Inc VAT
Angled or straight	VVIDETRV	<b>£158.00</b>	<b>£189.60</b>	<b>£158.00</b>	<b>£189.60</b>	<b>£195.00</b>	<b>£234.00</b>	<b>£195.00</b>	<b>£234.00</b>	<b>£195.00</b>	<b>£234.00</b>	<b>£195.00</b>	<b>£234.00</b>

## Ideal TRV Kits

Ideal TRV Kit consists of valves, pipe covers and shrouds, saving up to £21.00 compared to when bought separately.



Description	Model	Chrome Ex VAT	Chrome Inc VAT	White Ex VAT	White Inc VAT	Nickel Ex VAT	Nickel Inc VAT	Black Ex VAT	Black Inc VAT	Antique Copper Ex VAT	Antique Copper Inc VAT	Antique Brass Ex VAT	Antique Brass Inc VAT
Valve, Cover and Shroud Kit	VVIDETRVKIT	<b>£189.00</b>	<b>£226.80</b>	<b>£189.00</b>	<b>£226.80</b>	<b>£227.00</b>	<b>£272.40</b>	<b>£227.00</b>	<b>£272.40</b>	<b>£227.00</b>	<b>£272.40</b>	<b>£227.00</b>	<b>£272.40</b>

## Vintage TRV shown on pages 20, 22, 26, 76 & 79

The Vintage TRV valve offers great value.

- Made from die-cast brass
- Best suited to 2, 3, & 4 column Ancona's®
- Height 115mm
- Weight 460g
- Available from stock in 48-72 hours
- Made in Italy

<b>Pipe Centers</b> For angled valves allow an extra 90mm in total	<b>Valve Height</b> 115mm	<b>Please Note</b> Vintage TRV valves are not Bi-directional
---	------------------------------	---



Nickel Angled Wheelhead & Lockshield (Black Top)



Antique Copper Wheelhead (Walnut Top)



Polished Brass Wheelhead (Walnut Top)



Chrome Wheelhead (Black Top)



Antique Brass Wheelhead (Walnut Top)

Description	Model	Polished Brass Ex VAT	Polished Brass Inc VAT	Chrome Ex VAT	Chrome Inc VAT	Nickel Ex VAT	Nickel Inc VAT	Antique Brass Ex VAT	Antique Brass Inc VAT	Antique Copper Ex VAT	Antique Copper Inc VAT
Vintage TRV Angled	VVVINTRV	<b>£183.00</b>	<b>£219.60</b>	<b>£195.00</b>	<b>£234.00</b>	<b>£263.00</b>	<b>£315.60</b>	<b>£255.00</b>	<b>£306.00</b>	<b>£255.00</b>	<b>£306.00</b>
Vintage TRV Straight	VVVINTRV	£209.00	£250.80	<b>£225.00</b>	<b>£270.00</b>	£315.00	£378.00	£305.00	£366.00	£305.00	£366.00

Please note: all valves are sold in pairs, a lockshield & a wheelhead. Angled supplied as standard, please specify if you require straight valves. Straight Vintage TRV valves in Chrome are available from stock in 48-72 hours, all other finishes will be delivered in 5 weeks.

## Vintage TRV Kit

Kit consists of valves, pipe covers and shrouds, save up to £25.00 when buying the Vintage TRV Kit (see page 123 for images).

Description	Model	Polished Brass Ex VAT	Polished Brass Inc VAT	Chrome Ex VAT	Chrome Inc VAT	Nickel Ex VAT	Nickel Inc VAT	Antique Brass Ex VAT	Antique Brass Inc VAT	Antique Copper Ex VAT	Antique Copper Inc VAT
Angled Valve, Cover and Shroud Kit	VVVINTRVKIT	<b>£215.00</b>	<b>£258.00</b>	<b>£227.00</b>	<b>£272.40</b>	<b>£292.00</b>	<b>£350.40</b>	<b>£283.00</b>	<b>£339.60</b>	<b>£283.00</b>	<b>£339.60</b>
Straight Valve, Cover and Shroud Kit	VVVINTRVKIT	£239.00	£286.80	<b>£255.00</b>	<b>£306.00</b>	£347.00	£416.40	£337.00	£404.40	£337.00	£404.40

## Vintage TRV special corner valves

Vintage TRV valves are available in a selection of handed return angled valve options. Return angled valves are left and right-handed, you can select the correct option by identifying which side of the radiator has the flow connection; e.g flow connection on the left side requires a left-hand wheelhead and matching lockshield.

Please specify left or right-hand return for the wheelhead when ordering the return angled valves, Chrome is available from stock in 48-72 hours, delivery is 5 weeks for all other finishes. Please call 01342 302250 for more information.

Description	Model	Polished Brass Ex VAT	Polished Brass Inc VAT	Chrome Ex VAT	Chrome Inc VAT	Nickel Ex VAT	Nickel Inc VAT	Antique Brass Ex VAT	Antique Brass Inc VAT	Antique Copper Ex VAT	Antique Copper Inc VAT
Angled to Wall	VVVINTRV	£227.00	£272.40	<b>£245.00</b>	<b>£294.00</b>	£347.00	£416.40	£332.00	£398.40	£332.00	£398.40



Left-hand return angled valve in Chrome



Nickel Angled Wheelhead & Lockshield (Black Top)

## Vintage XL TRV

shown on pages 15,17, 27 & 83.

The Vintage XL TRVs large size creates an impactful presence.

- Made from die-cast brass
- Best suited to 5 & 6 column Ancona's® and Cast Iron radiators
- Height 160mm
- Weight 881g
- Available from stock in 48-72 hours
- Made in Italy

<b>Pipe Centers</b> For angled valves allow an extra 120mm in total	<b>Valve Height</b> 160mm	<b>Please Note</b> Vintage XL TRV valves are not Bi-directional
--	------------------------------	--



Polished Brass Wheelhead (Walnut Top)



Chrome Wheelhead (Black Top)



Antique Copper Wheelhead (Walnut Top)



Antique Brass Wheelhead (Black Top)

Description	Model	Polished Brass Ex VAT	Polished Brass Inc VAT	Chrome Ex VAT	Chrome Inc VAT	Nickel Ex VAT	Nickel Inc VAT	Antique Brass Ex VAT	Antique Brass Inc VAT	Antique Copper Ex VAT	Antique Copper Inc VAT
Angled	VVVINXLTRV	<b>£356.00</b>	<b>£427.20</b>	<b>£372.00</b>	<b>£446.40</b>	<b>£446.00</b>	<b>£535.20</b>	<b>£446.00</b>	<b>£535.20</b>	<b>£446.00</b>	<b>£535.20</b>

Please note: all valves are sold in pairs, a lockshield & a wheelhead. Angled only.

## Vintage XL TRV Kit

Kit consists of valves, pipe covers and shrouds, save up to £24.00 when buying the Vintage XL TRV Kit.



Description	Model	Polished Brass Ex VAT	Polished Brass Inc VAT	Chrome Ex VAT	Chrome Inc VAT	Nickel Ex VAT	Nickel Inc VAT	Antique Brass Ex VAT	Antique Brass Inc VAT	Antique Copper Ex VAT	Antique Copper Inc VAT
Valve, Cover and Shroud Kit	VVVINXLKIT	<b>£387.00</b>	<b>£464.40</b>	<b>£401.00</b>	<b>£481.20</b>	<b>£475.00</b>	<b>£570.00</b>	<b>£475.00</b>	<b>£570.00</b>	<b>£475.00</b>	<b>£570.00</b>

# Traditional Valves

Stocked valves are listed in bold & will be delivered in 48-72 hours.

## Black & Brass TRV

Delivered in 48-72 hours.



Brass Angled Wheelhead & Lockshield



Brass Straight Wheelhead & Lockshield



Chrome Straight Wheelhead & Lockshield



Chrome Angled Wheelhead & Lockshield

<b>Pipe Centers</b> For angled valves allow an extra 80mm in total	<b>Valve Height</b> 127mm	<b>Please Note</b> Black & Brass TRV valves are not Bi-directional
---	------------------------------	---

Description	Model	Brass Ex VAT	Brass Inc VAT	Chrome Ex VAT	Chrome Inc VAT
Angled or straight	VVNB&BTRV	<b>£178.00</b>	<b>£213.60</b>	<b>£187.00</b>	<b>£224.40</b>

Please note: all valves are sold in pairs, a lockshield and a wheelhead. Angled will be supplied as standard, please specify if you require straight valves.

## Pistol TRV shown on pages 53, 61, 63 & 73

Available in three standard finishes as well as painted options (see page 119), the Pistol TRV is available in angled or straight configurations.

Delivered in 48-72 hours.

<b>Pipe Centers</b> For angled valves allow an extra 80mm in total	<b>Valve Height</b> 128mm	<b>Please Note</b> Pistol TRV valves are not Bi-directional
---	------------------------------	--



Chrome Angled Wheelhead & Lockshield (shown in the fully open position)



White Angled Wheelhead



Nickel Angled Wheelhead

## Standard Finishes

Description	Model	Chrome Ex VAT	Chrome Inc VAT	White Ex VAT	White Inc VAT	Nickel Ex VAT	Nickel Inc VAT
Angled or Straight	VVPSLTRV	<b>£217.00</b>	<b>£260.40</b>	<b>£225.00</b>	<b>£270.00</b>	<b>£302.00</b>	<b>£362.40</b>

Please note: all valves are sold in pairs, a lockshield and a wheelhead. Angled will be supplied as standard, please specify if you require straight valves.

## Pistol TRV Kits

Pistol TRV Kit consists of valves, pipe covers and shrouds, save up to £25.00.

Description	Model	Chrome Ex VAT	Chrome Inc VAT	White Ex VAT	White Inc VAT	Nickel Ex VAT	Nickel Inc VAT
Valve, Cover and Shroud Kit	VVPSLTRVKIT	<b>£245.00</b>	<b>£294.00</b>	<b>£255.00</b>	<b>£306.00</b>	<b>£330.00</b>	<b>£396.00</b>



# Manual Valves for towel rails

Stocked valves are listed in bold & will be delivered in 48-72 hours.

## 3 Style Corner Valve

shown on pages 93, 96 & 103.



<b>Pipe Centers</b> For angled valves allow an extra 80mm in total	<b>Valve Height</b> 55mm	<b>Please Note</b> 3Style valves are not Bi-directional
---	-----------------------------	--

Description	Model	White Ex VAT	White Inc VAT	Chrome Ex VAT	Chrome Inc VAT	Silver Ex VAT	Silver Inc VAT
Angled or straight	VV3STY	<b>£180.00</b>	<b>£216.00</b>	<b>£156.00</b>	<b>£187.20</b>	<b>£198.00</b>	<b>£237.60</b>

Please note: all valves are sold in pairs, a lockshield and a wheelhead. Angled will be supplied as standard, please specify if you require straight valves.

## Mini Cube

shown on pages 98 & 100.



<b>Pipe Centers</b> For angled valves allow an extra 72mm in total	<b>Valve Height</b> 79mm	<b>Please Note</b> Mini Cube valves are not Bi-directional
---	-----------------------------	---

Description	Model	White Ex VAT	White Inc VAT	Chrome Ex VAT	Chrome Inc VAT	Nickel Ex VAT	Nickel Inc VAT
Angled Only	VVMICUAN	<b>£183.00</b>	<b>£219.60</b>	<b>£183.00</b>	<b>£219.60</b>	<b>£222.00</b>	<b>£266.40</b>

## Crosshead

shown on pages 114 & 115.



<b>Pipe Centers</b> For angled valves allow an extra 80mm in total	<b>Valve Height</b> 110mm	<b>Please Note</b> Crosshead valves are not Bi-directional
---	------------------------------	---

Valves are sold in pairs, a lockshield and a wheelhead. Angled supplied as standard, please specify if you require straight valves.

Description	Model	Chrome Ex VAT	Chrome Inc VAT	Antique Copper Ex VAT	Antique Copper Inc VAT	Nickel Ex VAT	Nickel Inc VAT
Angled or straight	VVCRO	<b>£184.00</b>	<b>£220.80</b>	<b>£245.00</b>	<b>£294.00</b>	<b>£288.00</b>	<b>£345.60</b>

This valve can be painted in a choice of 23 RAL colours and 30 Special Finishes see page 119

## Cylinder

shown on pages 102, 104 & 106.



<b>Pipe Centers</b> For angled valves allow an extra 80mm in total	<b>Valve Height</b> 85mm	<b>Please Note</b> Cylinder valves are not Bi-directional
---	-----------------------------	--

Valves are sold in pairs, a lockshield and a wheelhead. Angled supplied as standard, please specify if you require straight valves.

Description	Model	White Ex VAT	White Inc VAT	Chrome Ex VAT	Chrome Inc VAT	Nickel Ex VAT	Nickel Inc VAT
Angled or straight	VVCYL	<b>£118.00</b>	<b>£141.60</b>	<b>£118.00</b>	<b>£141.60</b>	<b>£143.00</b>	<b>£171.60</b>

This valve can be painted in a choice of 23 RAL colours and 30 Special Finishes see page 119

# Pipe Covers & Shrouds

Available in 7 set colours; White, Chrome, Antique Copper, Nickel, Polished Brass, Antique Brass & Black.

Pipe covers and shrouds are the perfect method of creating a neat finish for your radiators. They remove the need to paint copper pipes and hide unsightly holes drilled in the floor or wall for the feed pipe.

Available in 7 standard finishes, they can be delivered in 48-72 hours.

Each set is supplied with two 160mm covers and two shrouds.



Description	Model	Chrome Ex VAT	Chrome Inc VAT	Polished Brass Ex VAT	Polished Brass Inc VAT	White Ex VAT	White Inc VAT	Nickel Ex VAT	Nickel Inc VAT	Antique Copper Ex VAT	Antique Copper Inc VAT	Antique Brass Ex VAT	Antique Brass Inc VAT	Black Ex VAT	Black Inc VAT
DELIVERY TIMES		48-72 HOURS						48-72 HOURS							
Pipe covers	AAPIPECOV	£45.00	£54.00	£45.00	£54.00	£45.00	£54.00	£51.00	£61.20	£51.00	£61.20	£51.00	£61.20	£51.00	£61.20

Save money when you buy your pipe covers and shrouds as part of a valve kit, see page 118 for more information.

## Accessorise your Radiator

These towel bars are designed to fit our round-tubed designer radiators as well as selected models of our oval and rectangular tubed radiators in both single and double configurations, ideal for providing additional hanging space in your kitchen or bathroom to air towels or hang bathrobes. Available in White, Chrome plus 188 RAL Colours & 30 Special Finishes.

**White & Chrome delivered in 48-72 hours**, Colours delivered in up to 3 weeks.

### Towel Bars

Description	Length	Model	White Ex VAT	White Inc VAT	Colour Ex VAT	Colour Inc VAT	Chrome Ex VAT	Chrome Inc VAT
DELIVERY TIMES			48-72 HOURS		UP TO 3 WEEKS		48-72 HOURS	
Round Hanging Bar - Small	370mm	AAHB370	£55.00	£66.00	£71.00	£85.20	£81.00	£97.20
Round Hanging Bar - Large	480mm	AAHB480	£62.00	£74.40	£76.00	£91.20	£93.00	£111.60
Square Hanging Bar - Small	450mm	AAHB450	£55.00	£66.00	£71.00	£85.20	£81.00	£97.20
Square Hanging Bar - Large	550mm	AAHB550	£62.00	£74.40	£76.00	£91.20	£93.00	£111.60



Square Hanging Bar Large White



Round Hanging Bar Large White

### Hanging Pegs

Description	Height	Model	White Ex VAT	White Inc VAT	Colour Ex VAT	Colour Inc VAT	Chrome Ex VAT	Chrome Inc VAT
DELIVERY TIMES			48-72 HOURS		UP TO 3 WEEKS		48-72 HOURS	
Square Hanging Peg	50mm	AAHPSQ50	£55.00	£66.00	£70.00	£84.00	£75.00	£90.00
Round Hanging Peg	55mm	AAHPRO55	£55.00	£66.00	£70.00	£84.00	£75.00	£90.00



Round Hanging Bar Small Chrome

A nominal £5 charge for postage & packing will be applied to any orders under £50 in value.

# Ancona® Accessories

## Ancona® Towel Bars & Pegs

Adapt your Ancona® for the bathroom or kitchen with a towel bar or peg.  
Available from stock.

### Towel Bars

Ancona's must be a minimum of 8 sections wide in order for a towel bar to fit

Description	Model	Price Ex VAT	Price Inc VAT
DELIVERY TIMES		48-72 HOURS	
To fit 8 sections or more	PPANCSTB08	£64.00	£76.80
To fit 10 sections or more	PPANCSTB10	£75.00	£90.00

Please Note: The towel bar will sit off centre for Ancona radiators that have an uneven number of sections.



Ancona® Towel Bar Chrome



Ancona® Pegs Chrome



Ancona® Towel Bar Chrome

### Pegs

Description	Model	Chrome Ex VAT	Chrome Inc VAT	Colour Ex VAT	Colour Inc VAT
DELIVERY TIMES		48-72 HOURS		UP TO 3 WEEKS	
Square 50mm Peg	PPANCSSQ50	£75.00	£90.00	£70.00	£84.00
Round 55mm Peg	PPANCSTB10	£75.00	£90.00	£70.00	£84.00

## Optional Solid Brass Wall Ties & Airvents New

These solid brass wall ties provide a stylish finishing touch to any Ancona® radiator; select to match your valves.  
Available as a kit including matching airvent and blanking plug in Antique Brass, Chrome, Polished Brass and Brushed Nickel.  
Please note these wall ties and airvents are an optional extra and do not come as standard with your Ancona® radiator.

Description	Model	Number of Wall Ties	Number of Airvents	Number of Blank Plugs	Price Ex VAT	Price Inc VAT
DELIVERY TIMES					48-72 HOURS	
Single Wall Tie	PPANWT	1	N/A	N/A	£64.00	£76.80
Single Airvent & Blank Plug	PPLAVBP	N/A	1	1	£18.00	£21.60
Wall Tie, Airvent & Blank Plug Kit	PPANWTAVKIT2	2	1	1	£140.00	£168.00
Wall Tie, Airvent & Blank Plug Kit	PPANWTAVKIT3	3	1	1	£198.00	£237.60
Wall Tie, Airvent & Blank Plug Kit	PPANWTAVKIT4	4	1	1	£258.00	£309.60
Wall Tie, Airvent & Blank Plug Kit	PPANWTAVKIT5	5	1	1	£318.00	£381.60

Antique Brass

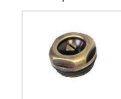

Chrome



Polished Brass

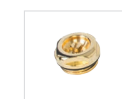

Brushed Nickel

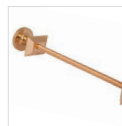
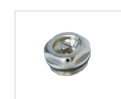

### Manual Brass Airvents

As an alternative, why not order an Ancona® manual brass airvent to co-ordinate with your chosen colour or to match your valve. 1 airvent is needed per Ancona® radiator; please specify at time of order. **Available from stock.**

Description	Model	Price Ex VAT	Price Inc VAT
DELIVERY TIMES		48-72 HOURS	
Brass airvent	PPAVB	£4.00	£4.80



® Ancona is a registered trademark of IRSAP UK Limited

A nominal £5 charge for postage & packing will be applied to any orders under £50 in value.

# Ancona® Stock pages 8-15

High quality Italian design & manufacture.

Steel multi column 45mm sections. CE/UKCA approved & certified to BS EN442.

White RAL 9016 as standard, Feature Finishes: Copper, Pearl Bronze & Textured Anthracite. (Please call **01342 302250** for sample swatches)  
Colour Coordination Service available, see pages 6-7 for full details.

**Stock White RAL 9016: 48-72 Hours**

Feature Finishes: Up to 3 weeks

45

All sections  
45mm wide



## Vintage TRV Kit

**SAVE £45**

WHEN YOU BUY A VINTAGE TRV KIT WITH ANY ANCONA® ORDER\* QUOTING **PROMOV2** AT TIME OF ORDER

\*Saving based on the value of individual items when bought separately. Order any of our selected valves and matching pipe covers at the same time as your radiator.

## Online Radiator Builder

Use our **NEW ONLINE RADIATOR BUILDER** to help you select the best solution for your room. It will take you through the process quickly and easily and allows you to save your ideas to your own Wish List. To select the right size of radiator for your room you need to calculate the BTU (heat output) you require to heat your room, you can use our online calculator to work this out.

Go to our new website [theradiatorcompany.co.uk](http://theradiatorcompany.co.uk)



Edit Build	
<b>Build Summary</b>	
Radiator Columns	3
Height & Length	H 500mm x L 1016mm
Color	Standard White
Mounting Options	Welded Feet
Valve	Ideal TRV Angled Valve White
Lead Time	48-72 hours
BTU value of this selection is: ⓘ	
<b>BTU:3828</b>	
<b>Watts:1122</b>	
Not sure? <a href="#">Check BTU</a>	
Total price:	<a href="#">Add to Basket</a> <a href="#">Add to Wishlist</a>

- 1 Calculate the heat output you need for your room, using our **online BTU (Heat Output) Calculator** or check with your installer, remember you may need more than one radiator to heat your room.
- 2 Use the tables on pages 130-137 to find the best size to suit your space and heat output you need; if you cannot get the right size and output combination from a 2 column radiator try an alternative height or column (depth) option.
- 3 Choose the style of mounting option you want; for Ancona stock white & Feature Finishes standard wall brackets are included in the radiator price, for Bare Metal Lacquer Ancona stock universal wall brackets only are included in the price
- 4 If selecting cast feet or slip on welded feet there is an additional cost, see right for cast feet and slip on welded feet kits and page 137 for bare metal lacquer slip on welded feet pricing tables.

If you need an alternative size, there are thousands of other sizes we can make to order from the full Ancona range which can be found on pages 140-145



# Ancona® Stock White & Feature Finishes Mounting Options

**Mounting Options for Ancona Stock in White & Feature Finishes, (Bare Metal Lacquer mounting options can be found on page 137)**

Once you have chosen your radiator size simply choose your preferred mounting option; standard wall brackets are included in the radiator price. Cast feet and slip on welded feet are an additional cost, see pricing tables below.

We will supply the correct number of brackets and wall ties with each order; prices for extra brackets / feet and wall ties are available on request, please call **01342 302250**.

Note: Ancona's over 40 sections will incur a £35 joining charge, please see bottom of this page for more information

Please specify your preferred mounting option at time of order (remember cast feet and slip on welded feet are not included in the radiator price)

Note: Ancona's must be a minimum of 100mm from the floor for all mounting options

## Wall mounting options included in radiator price

### Standard wall brackets

Supplied as standard with every Ancona order unless an alternative is specified.

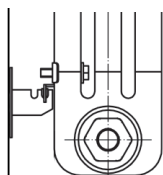

Pipe centres from wall:  
 2 column = 64mm - 74mm  
 3 column = 82mm - 92mm  
 4 column = 102mm - 112mm

### Wall ties



adjustable from 32mm to 42mm

## Optional cast feet kit prices (includes wall ties)

Section & Column Range	No. of Feet	Model	White Ex VAT	White Inc VAT	Feature Finishes Ex VAT	Feature Finishes Inc VAT
DELIVERY TIMES			48-72 HOURS		UP TO 3 WEEKS	
2-20 Sections / 2-4 Columns	2	PPANCSCFKIT2	£54.00	£64.80	£72.00	£86.40
21-30 Sections / 2-4 Columns	3	PPANCSCFKIT3	£81.00	£97.20	£108.00	£129.60
31-40 Sections / 2-4 Columns	4	PPANCSCFKIT4	£108.00	£129.60	£144.00	£172.80

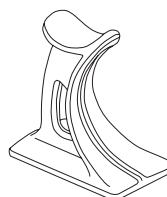

Pipe centres from wall:  
 2 column = 64mm - 74mm  
 3 column = 82mm - 92mm  
 4 column = 102mm - 112mm

Note: Please remember to add 100mm to the height of the Ancona section you have chosen if you are using cast feet.

## Optional slip on welded feet kit prices (includes wall ties)

Sections	No. of Feet	Model	White Ex VAT	White Inc VAT	Feature Finishes Ex VAT	Feature Finishes Inc VAT
DELIVERY TIMES			48-72 HOURS		UP TO 3 WEEKS	
Up to 20 Sections	2	PPANCSSOFKIT2	£78.00	£93.60	£106.00	£127.20
21-39 (odd number of sections)	3	PPANCSSOFKIT3	£117.00	£140.40	£159.00	£190.80
22-40 (even number of sections)	4	PPANCSSOFKIT4	£156.00	£187.20	£212.00	£254.40

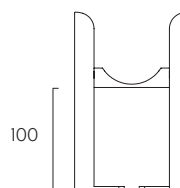

Pipe centres from wall:  
 2 column = 64mm - 74mm  
 3 column = 82mm - 92mm  
 4 column = 102mm - 112mm

Note: Please remember to add 100mm to the height of the Ancona section you have chosen if you are using slip on welded feet.

## Nylon Spanner

The perfect tool for tightening Ancona Bushes and air vents. An exact fit, this robust nylon spanner reduces the risk of damaging your radiator with inappropriate metal tools.

Description	Model	Price Ex VAT	Price Ex VAT
DELIVERY TIMES		48-72 HOURS	
Nylon Spanner	MCSPANNER	£10.00	£12.00



## Helpful notes & advice;

Please call us on **01342 302250** if you need any further information or help with specifying your Ancona.

Due to transport and handling restrictions, Stock Ancona's are supplied pre-assembled up to a maximum of 40 sections. For radiators outside these parameters there is an additional joining charge, please consult Customer Services to discuss alternative requirements. All Ancona's come supplied as a finished radiator with ½" B.O.E. (Bottom Opposite End) connections as standard.

**A nominal £5 charge for postage and packing will be applied to any orders under £50 in value**



## 1800mm High

Width (mm)	Sections	Model	Watts Δt 50°C	Btu's Δt 50°C	White Ex VAT	White Inc VAT	Feature Finishes Ex VAT	Feature Finishes Inc VAT
DELIVERY TIMES					48-72 HOURS		UP TO 3 WEEKS	
161	3	ANCS2C18X3	372	1269	£151.05	£181.26	£225.36	£270.43
206	4	ANCS2C18X4	496	1692	£201.40	£241.68	£300.48	£360.58
251	5	ANCS2C18X5	620	2115	£251.75	£302.10	£375.60	£450.72
296	6	ANCS2C18X6	744	2539	£302.10	£362.52	£450.72	£540.86
341	7	ANCS2C18X7	868	2962	£352.45	£422.94	£525.84	£631.01
386	8	ANCS2C18X8	992	3385	£402.80	£483.36	£600.96	£721.15
431	9	ANCS2C18X9	1116	3808	£453.15	£543.78	£676.08	£811.30
476	10	ANCS2C18X10	1240	4231	£503.50	£604.20	£751.20	£901.44
521	11	ANCS2C18X11	1364	4654	£553.85	£664.62	£826.32	£991.58
566	12	ANCS2C18X12	1488	5077	£604.20	£725.04	£901.44	£1,081.73
611	13	ANCS2C18X13	1612	5500	£654.55	£785.46	£976.56	£1,171.87
656	14	ANCS2C18X14	1736	5923	£704.90	£845.88	£1,051.68	£1,262.02
701	15	ANCS2C18X15	1860	6346	£755.25	£906.30	£1,126.80	£1,352.16
746	16	ANCS2C18X16	1984	6769	£805.60	£966.72	£1,201.92	£1,442.30
791	17	ANCS2C18X17	2108	7192	£855.95	£1,027.14	£1,277.04	£1,532.45
836	18	ANCS2C18X18	2232	7616	£906.30	£1,087.56	£1,352.16	£1,622.59
881	19	ANCS2C18X19	2356	8039	£956.65	£1,147.98	£1,427.28	£1,712.74
926	20	ANCS2C18X20	2480	8462	£1,007.00	£1,208.40	£1,502.40	£1,802.88

Widths include measurement for bushes.

Please note due to manufacturing tolerances widths shown may vary by +/- 2mm.

## Feature Finishes

### Copper

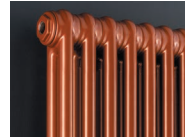

### Textured Anthracite



### Pearl Bronze



Please call **01342 302250** for sample swatches

## Mounting options for stock sizes

Once you have chosen your radiator size, simply choose your preferred mounting option; standard wall brackets are included in the radiator price.

## Floor mounting options

Cast feet and slip on welded feet are an additional cost, see pricing tables below.

We will supply the correct number of brackets and wall ties with each order; prices for extra brackets / feet and wall ties are available on request, please call 01342 302250.

Ancona's must be a minimum of 100mm from the floor for all mounting options

Note: Ancona's over 40 sections will incur a £35 joining charge, please see bottom of page 129 for more information.

## Wall mounting options included in radiator price

### Standard wall brackets

These will always be supplied with every Ancona order unless an alternative is specified at time of order

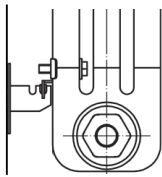

Pipe centres from wall:

2 column = 64mm - 74mm

3 column = 82mm - 92mm

4 column = 102mm - 112mm

### Wall ties



adjustable from 32 to 42mm

## Optional cast feet kit prices (includes wall ties)

Section & Column Range	No. of Feet	Model	White Ex VAT	White Inc VAT	Feature Finishes Ex VAT	Feature Finishes Inc VAT
DELIVERY TIMES			48-72 HOURS		UP TO 3 WEEKS	
2-20 Sections / 2-4 Columns	2	PPANCSCFKIT2	£54.00	£64.80	£72.00	£86.40
21-30 Sections / 2-4 Columns	3	PPANCSCFKIT3	£81.00	£97.20	£108.00	£129.60
31-40 Sections / 2-4 Columns	4	PPANCSCFKIT4	£108.00	£129.60	£144.00	£172.80

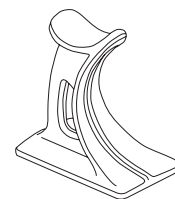

100

Pipe centres from wall:

2 column = 64mm - 74mm

3 column = 82mm - 92mm

4 column = 102mm - 112mm

Note: Please remember to add 100mm to the height of the Ancona section you have chosen if you are using cast feet.

## Optional Slip on welded feet kit prices (includes wall ties)

Sections	No. of Feet	Model	White Ex VAT	White Inc VAT	Feature Finishes Ex VAT	Feature Finishes Inc VAT
DELIVERY TIMES			48-72 HOURS		UP TO 3 WEEKS	
Up to 20 Sections	2	PPANCSSOFKIT2	£78.00	£93.60	£106.00	£127.20
21-39 (odd number of sections)	3	PPANCSSOFKIT3	£117.00	£140.40	£159.00	£190.80
22-40 (even number of sections)	4	PPANCSSOFKIT4	£156.00	£187.20	£212.00	£254.40

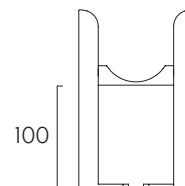

100

Pipe centres from wall:

2 column = 64mm - 74mm

3 column = 82mm - 92mm

4 column = 102mm - 112mm

Note: Please remember to add 100mm to the height of the Ancona section you have chosen if you are using slip on welded feet.



## 750mm High

Width (mm)	Sections	Model	Watts At 50°C	Btu's At 50°C	White Ex VAT	White Inc VAT	Feature Finishes Ex VAT	Feature Finishes Inc VAT
DELIVERY TIMES					48-72 HOURS		UP TO 3 WEEKS	
161	3	ANCS3C75X3	222	757	£90.15	£108.18	£174.51	£209.41
206	4	ANCS3C75X4	296	1010	£120.20	£144.24	£232.68	£279.22
251	5	ANCS3C75X5	370	1262	£150.25	£180.30	£290.85	£349.02
296	6	ANCS3C75X6	444	1515	£180.30	£216.36	£349.02	£418.82
341	7	ANCS3C75X7	518	1767	£210.35	£252.42	£407.19	£488.63
386	8	ANCS3C75X8	592	2020	£240.40	£288.48	£465.36	£558.43
431	9	ANCS3C75X9	666	2272	£270.45	£324.54	£523.53	£628.24
476	10	ANCS3C75X10	740	2525	£300.50	£360.60	£581.70	£698.04
521	11	ANCS3C75X11	814	2777	£330.55	£396.66	£639.87	£767.84
566	12	ANCS3C75X12	888	3030	£360.60	£432.72	£698.04	£837.65
611	13	ANCS3C75X13	962	3282	£390.65	£468.78	£756.21	£907.45
656	14	ANCS3C75X14	1036	3535	£420.70	£504.84	£814.38	£977.26
701	15	ANCS3C75X15	1110	3787	£450.75	£540.90	£872.55	£1,047.06
746	16	ANCS3C75X16	1184	4040	£480.80	£576.96	£930.72	£1,116.86
791	17	ANCS3C75X17	1258	4292	£510.85	£613.02	£988.89	£1,186.67
836	18	ANCS3C75X18	1332	4545	£540.90	£649.08	£1,047.06	£1,256.47
881	19	ANCS3C75X19	1406	4797	£570.95	£685.14	£1,105.23	£1,326.28
926	20	ANCS3C75X20	1480	5050	£601.00	£721.20	£1,163.40	£1,396.08
971	21	ANCS3C75X21	1554	5302	£631.05	£757.26	£1,221.57	£1,465.88
1016	22	ANCS3C75X22	1628	5555	£661.10	£793.32	£1,279.74	£1,535.69
1061	23	ANCS3C75X23	1702	5807	£691.15	£829.38	£1,337.91	£1,605.49
1106	24	ANCS3C75X24	1776	6060	£721.20	£865.44	£1,396.08	£1,675.30
1151	25	ANCS3C75X25	1850	6312	£751.25	£901.50	£1,454.25	£1,745.10
1196	26	ANCS3C75X26	1924	6565	£781.30	£937.56	£1,512.42	£1,814.90
1241	27	ANCS3C75X27	1998	6817	£811.35	£973.62	£1,570.59	£1,884.71
1286	28	ANCS3C75X28	2072	7070	£841.40	£1,009.68	£1,628.76	£1,954.51
1331	29	ANCS3C75X29	2146	7322	£871.45	£1,045.74	£1,686.93	£2,024.32
1376	30	ANCS3C75X30	2220	7575	£901.50	£1,081.80	£1,745.10	£2,094.12
1421	31	ANCS3C75X31	2294	7827	£931.55	£1,117.86	£1,803.27	£2,163.92
1466	32	ANCS3C75X32	2368	8080	£961.60	£1,153.92	£1,861.44	£2,233.73
1511	33	ANCS3C75X33	2442	8332	£991.65	£1,189.98	£1,919.61	£2,303.53
1556	34	ANCS3C75X34	2516	8585	£1,021.70	£1,226.04	£1,977.78	£2,373.34
1601	35	ANCS3C75X35	2590	8837	£1,051.75	£1,262.10	£2,035.95	£2,443.14
1646	36	ANCS3C75X36	2664	9090	£1,081.80	£1,298.16	£2,094.12	£2,512.94
1691	37	ANCS3C75X37	2738	9342	£1,111.85	£1,334.22	£2,152.29	£2,582.75
1736	38	ANCS3C75X38	2812	9595	£1,141.90	£1,370.28	£2,210.46	£2,652.55
1781	39	ANCS3C75X39	2886	9847	£1,171.95	£1,406.34	£2,268.63	£2,722.36
1826	40	ANCS3C75X40	2960	10100	£1,202.00	£1,442.40	£2,326.80	£2,792.16

## Optional Solid Brass Wall Ties & Airvents New

These solid brass wall ties provide a stylish finishing touch to any Ancona® radiator; select to match your valves. Available as a kit including matching airvent and blank plug in Antique Brass, Chrome, Polished Brass and Brushed Nickel. Please note these wall ties and airvents are an optional extra and do not come as standard with your Ancona® radiator.

Description	Model	Number of Wall Ties	Number of Airvents	Number of Blank Plugs	Price Ex VAT	Price Inc VAT
DELIVERY TIMES		48-72 HOURS				
Single Wall Tie	PPANWT	1	N/A	N/A	£64.00	£76.80
Single Airvent & Blank Plug	PPLAVBP	N/A	1	1	£18.00	£21.60
Wall Tie, Airvent & Blank Plug Kit	PPANWTAVKIT2	2	1	1	£140.00	£168.00
Wall Tie, Airvent & Blank Plug Kit	PPANWTAVKIT3	3	1	1	£198.00	£237.60
Wall Tie, Airvent & Blank Plug Kit	PPANWTAVKIT4	4	1	1	£258.00	£309.60
Wall Tie, Airvent & Blank Plug Kit	PPANWTAVKIT5	5	1	1	£318.00	£381.60

Antique Brass

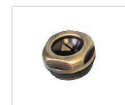

Chrome



Polished Brass

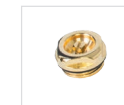

Brushed Nickel

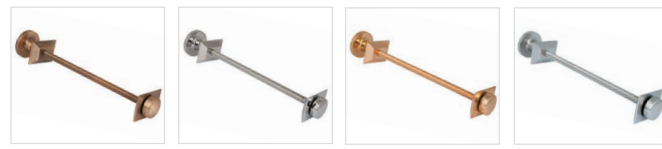

Please specify your finish at time of order

\*Saving based on the value of individual items when bought separately. Order any of our selected valves and matching pipe covers at the same time as your radiator.

## 1800mm High

Width (mm)	Sections	Model	Watts At 50°C	Btu's At 50°C	White Ex VAT	White Inc VAT	Feature Finishes Ex VAT	Feature Finishes Inc VAT
DELIVERY TIMES					48-72 HOURS		UP TO 3 WEEKS	
161	3	ANCS3C18X3	504	1720	£197.64	£237.17	£284.55	£341.46
206	4	ANCS3C18X4	672	2293	£263.52	£316.22	£379.40	£455.28
251	5	ANCS3C18X5	840	2866	£329.40	£395.28	£474.25	£569.10
296	6	ANCS3C18X6	1008	3439	£395.28	£474.34	£569.10	£682.92
341	7	ANCS3C18X7	1176	4013	£461.16	£553.39	£663.95	£796.74
386	8	ANCS3C18X8	1344	4586	£527.04	£632.45	£758.80	£910.56
431	9	ANCS3C18X9	1512	5159	£592.92	£711.50	£853.65	£1,024.38
476	10	ANCS3C18X10	1680	5732	£658.80	£790.56	£948.50	£1,138.20
521	11	ANCS3C18X11	1848	6305	£724.68	£869.62	£1,043.35	£1,252.02
566	12	ANCS3C18X12	2016	6879	£790.56	£948.67	£1,138.20	£1,365.84
611	13	ANCS3C18X13	2184	7452	£856.44	£1,027.73	£1,233.05	£1,479.66
656	14	ANCS3C18X14	2352	8025	£922.32	£1,106.78	£1,327.90	£1,593.48
701	15	ANCS3C18X15	2520	8598	£988.20	£1,185.84	£1,422.75	£1,707.30
746	16	ANCS3C18X16	2688	9171	£1,054.08	£1,264.90	£1,517.60	£1,821.12
791	17	ANCS3C18X17	2856	9745	£1,119.96	£1,343.95	£1,612.45	£1,934.94
836	18	ANCS3C18X18	3024	10318	£1,185.84	£1,423.01	£1,707.30	£2,048.76
881	19	ANCS3C18X19	3192	10891	£1,251.72	£1,502.06	£1,802.15	£2,162.58
926	20	ANCS3C18X20	3360	11464	£1,317.60	£1,581.12	£1,897.00	£2,276.40

### Feature Finishes

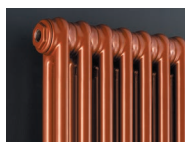

Copper; A bright finish with red and gold tones. Copper is a very popular finish.



Pearl Bronze; A deep lustrous finish, the combination of darker and lighter tones creates a patina effect and an aged look.



Textured Anthracite; this earthy near black/anthracite finish pairs well with many colour schemes, providing a sophisticated tone and nuance.

Please call **01342 302250** for sample swatches

### Mounting options for stock sizes

Once you have chosen your radiator size simply choose your preferred mounting option; standard wall brackets are included in the radiator price see pages 131 for technical drawings and pipe centres.

### Floor mounting options

Optional Cast feet & slip on welded feet are an additional cost, see pricing tables & technical drawings on pages 131/ 135.





# Ancona® Bare Metal Lacquer pages 16-17

High quality Italian design & manufacture.  
Steel multi column (2, 3 and 4 column options)  
45mm sections.  
CE/UKCA approved & certified to BS EN442.

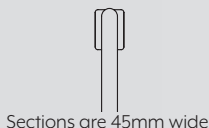

Bare Metal Lacquer

**Bare Metal Lacquer: 48-72 Hours**

All prices include universal wall brackets (optional slip on feet shown page 137).  
The radiators widths include bushes.  
Pipe centres left to right = width + valves.



**SAVE £45** WHEN YOU BUY OUR **VINTAGE TRV KIT** WITH ANY ANCONA® ORDER\*  
QUOTING **PROMOV2** AT TIME OF ORDER

For all Vintage TRV finishes

This finish highlights the raw basic steel product showcasing the manufacturing marks created by the processes of welding and sanding to deliver an industrial look. Each radiator will be unique, with the random position of the weld lines on the column tubes and the level of the final sanding. The clear lacquer allows these characteristics to be the hero and maintains the natural steel finish. Please see page 137 (right) for examples of weld lines and sanding marking.

## 2 Column - 1800mm High

Width (mm)	Sections	Model	Watts Δt 50°C	Btu's Δt 50°C	Lacquer	
					Ex VAT	Inc VAT
DELIVERY TIMES					48-72 HOURS	
161	3	ANCS2C18X3L	372	1269	£188.82	£226.58
206	4	ANCS2C18X4L	496	1692	£251.76	£302.11
251	5	ANCS2C18X5L	620	2115	£314.70	£377.64
296	6	ANCS2C18X6L	744	2539	£377.64	£453.17
341	7	ANCS2C18X7L	868	2962	£440.58	£528.70
386	8	ANCS2C18X8L	992	3385	£503.52	£604.22
431	9	ANCS2C18X9L	1116	3808	£566.46	£679.75
476	10	ANCS2C18X10L	1240	4231	£629.40	£755.28
521	11	ANCS2C18X11L	1364	4654	£692.34	£830.81

Width (mm)	Sections	Model	Watts Δt 50°C	Btu's Δt 50°C	Lacquer	
					Ex VAT	Inc VAT
DELIVERY TIMES					48-72 HOURS	
566	12	ANCS2C18X12L	1488	5077	£755.28	£906.34
611	13	ANCS2C18X13L	1612	5500	£818.22	£981.86
656	14	ANCS2C18X14L	1736	5923	£881.16	£1,057.39
701	15	ANCS2C18X15L	1860	6346	£944.10	£1,132.92
746	16	ANCS2C18X16L	1984	6769	£1,007.04	£1,208.45
791	17	ANCS2C18X17L	2108	7192	£1,069.98	£1,283.98
836	18	ANCS2C18X18L	2232	7616	£1,132.92	£1,359.50
881	19	ANCS2C18X19L	2356	8039	£1,195.86	£1,435.03
926	20	ANCS2C18X20L	2480	8462	£1,258.80	£1,510.56

2 Column - 65mm



Widths include measurement for bushes. Please note due to manufacturing tolerances widths shown may vary by +/- 2mm.

## 3 Column - 500mm High

Width (mm)	Sections	Model	Watts Δt 50°C	Btu's Δt 50°C	Lacquer	
					Ex VAT	Inc VAT
DELIVERY TIMES					48-72 HOURS	
161	3	ANCS3C50X3L	153	522	£102.72	£123.26
206	4	ANCS3C50X4L	204	696	£136.96	£164.35
251	5	ANCS3C50X5L	255	870	£171.20	£205.44
296	6	ANCS3C50X6L	306	1044	£205.44	£246.53
341	7	ANCS3C50X7L	357	1218	£239.68	£287.62
386	8	ANCS3C50X8L	408	1392	£273.92	£328.70
431	9	ANCS3C50X9L	459	1566	£308.16	£369.79
476	10	ANCS3C50X10L	510	1740	£342.40	£410.88
521	11	ANCS3C50X11L	561	1914	£376.64	£451.97
566	12	ANCS3C50X12L	612	2088	£410.88	£493.06
611	13	ANCS3C50X13L	663	2262	£445.12	£534.14
656	14	ANCS3C50X14L	714	2436	£479.36	£575.23
701	15	ANCS3C50X15L	765	2610	£513.60	£616.32
746	16	ANCS3C50X16L	816	2784	£547.84	£657.41
791	17	ANCS3C50X17L	867	2958	£582.08	£698.50
836	18	ANCS3C50X18L	918	3132	£616.32	£739.58
881	19	ANCS3C50X19L	969	3306	£650.56	£780.67
926	20	ANCS3C50X20L	1020	3480	£684.80	£821.76
971	21	ANCS3C50X21L	1071	3654	£719.04	£862.85

Width (mm)	Sections	Model	Watts Δt 50°C	Btu's Δt 50°C	Lacquer	
					Ex VAT	Inc VAT
DELIVERY TIMES					48-72 HOURS	
1016	22	ANCS3C50X22L	1122	3828	£753.28	£903.94
1061	23	ANCS3C50X23L	1173	4002	£787.52	£945.02
1106	24	ANCS3C50X24L	1224	4176	£821.76	£986.11
1151	25	ANCS3C50X25L	1275	4350	£856.00	£1,027.20
1196	26	ANCS3C50X26L	1326	4524	£890.24	£1,068.29
1241	27	ANCS3C50X27L	1377	4698	£924.48	£1,109.38
1286	28	ANCS3C50X28L	1428	4872	£958.72	£1,150.46
1331	29	ANCS3C50X29L	1479	5046	£992.96	£1,191.55
1376	30	ANCS3C50X30L	1530	5220	£1,027.20	£1,232.64
1421	31	ANCS3C50X31L	1581	5394	£1,061.44	£1,273.73
1466	32	ANCS3C50X32L	1632	5568	£1,095.68	£1,314.82
1511	33	ANCS3C50X33L	1683	5742	£1,129.92	£1,355.90
1556	34	ANCS3C50X34L	1734	5916	£1,164.16	£1,396.99
1601	35	ANCS3C50X35L	1785	6090	£1,198.40	£1,438.08
1646	36	ANCS3C50X36L	1836	6264	£1,232.64	£1,479.17
1691	37	ANCS3C50X37L	1887	6438	£1,266.88	£1,520.26
1736	38	ANCS3C50X38L	1938	6612	£1,301.12	£1,561.34
1781	39	ANCS3C50X39L	1989	6786	£1,335.36	£1,602.43
1826	40	ANCS3C50X40L	2040	6960	£1,369.60	£1,643.52

3 Column - 101mm



4 Column - 139mm



Sections are 45mm wide

Widths include measurement for bushes. Please note due to manufacturing tolerances widths shown may vary by +/- 2mm.



### 3 Column - 600mm High

Width (mm)	Sections	Model	Watts Δt 50°C	Btu's Δt 50°C	Lacquer Ex VAT	Lacquer Inc VAT
DELIVERY TIMES			48-72 HOURS			
161	3	ANCS3C60X3L	180	614	£103.74	£124.49
206	4	ANCS3C60X4L	240	819	£138.32	£165.98
251	5	ANCS3C60X5L	300	1024	£172.90	£207.48
296	6	ANCS3C60X6L	360	1228	£207.48	£248.98
341	7	ANCS3C60X7L	420	1433	£242.06	£290.47
386	8	ANCS3C60X8L	480	1638	£276.64	£331.97
431	9	ANCS3C60X9L	540	1842	£311.22	£373.46
476	10	ANCS3C60X10L	600	2047	£345.80	£414.96
521	11	ANCS3C60X11L	660	2252	£380.38	£456.46
566	12	ANCS3C60X12L	720	2457	£414.96	£497.95
611	13	ANCS3C60X13L	780	2661	£449.54	£539.45
656	14	ANCS3C60X14L	840	2866	£484.12	£580.94
701	15	ANCS3C60X15L	900	3071	£518.70	£622.44
746	16	ANCS3C60X16L	960	3276	£553.28	£663.94
791	17	ANCS3C60X17L	1020	3480	£587.86	£705.43
836	18	ANCS3C60X18L	1080	3685	£622.44	£746.93
881	19	ANCS3C60X19L	1140	3890	£657.02	£788.42
926	20	ANCS3C60X20L	1200	4094	£691.60	£829.92
971	21	ANCS3C60X21L	1260	4299	£726.18	£871.42
1016	22	ANCS3C60X22L	1320	4504	£760.76	£912.91
1061	23	ANCS3C60X23L	1380	4709	£795.34	£954.41
1106	24	ANCS3C60X24L	1440	4913	£829.92	£995.90
1151	25	ANCS3C60X25L	1500	5118	£864.50	£1,037.40
1196	26	ANCS3C60X26L	1560	5323	£899.08	£1,078.90
1241	27	ANCS3C60X27L	1620	5527	£933.66	£1,120.39
1286	28	ANCS3C60X28L	1680	5732	£968.24	£1,161.89
1331	29	ANCS3C60X29L	1740	5937	£1,002.82	£1,203.38
1376	30	ANCS3C60X30L	1800	6142	£1,037.40	£1,244.88
1421	31	ANCS3C60X31L	1860	6346	£1,071.98	£1,286.38
1466	32	ANCS3C60X32L	1920	6551	£1,106.56	£1,327.87
1511	33	ANCS3C60X33L	1980	6756	£1,141.14	£1,369.37
1556	34	ANCS3C60X34L	2040	6960	£1,175.72	£1,410.86
1601	35	ANCS3C60X35L	2100	7165	£1,210.30	£1,452.36
1646	36	ANCS3C60X36L	2160	7370	£1,244.88	£1,493.86
1691	37	ANCS3C60X37L	2220	7575	£1,279.46	£1,535.35
1736	38	ANCS3C60X38L	2280	7779	£1,314.04	£1,576.85
1781	39	ANCS3C60X39L	2340	7984	£1,348.62	£1,618.34
1826	40	ANCS3C60X40L	2400	8189	£1,383.20	£1,659.84

Widths include measurement for bushes. Please note due to manufacturing tolerances widths shown may vary by +/- 2mm.

**Once you have chosen your radiator size simply choose your preferred mounting option (below).**

Universal wall brackets are included in your radiator price. Slip on welded feet are an additional cost, please see kit prices below. Please specify slip on welded feet at time of order (fittings are available to order with a corresponding radiator only). The correct number of wall brackets are supplied with each order; prices for extra wall brackets are available on request, please call 01342 302250.

#### Universal wall brackets (included in radiator price)

Supplied as standard with all lacquer stock Ancona's\*

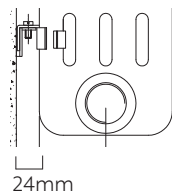

Pipe centres from wall:  
 2 column = 56mm  
 3 column = 74mm  
 4 column = 93mm

24mm

### 4 Column - 600mm High

Width (mm)	Sections	Model	Watts Δt 50°C	Btu's Δt 50°C	Lacquer Ex VAT	Lacquer Inc VAT
DELIVERY TIMES			48-72 HOURS			
161	3	ANCS4C60X3L	237	809	£125.25	£150.30
206	4	ANCS4C60X4L	316	1078	£167.00	£200.40
251	5	ANCS4C60X5L	395	1348	£208.75	£250.50
296	6	ANCS4C60X6L	474	1617	£250.50	£300.60
341	7	ANCS4C60X7L	553	1887	£292.25	£350.70
386	8	ANCS4C60X8L	632	2156	£334.00	£400.80
431	9	ANCS4C60X9L	711	2426	£375.75	£450.90
476	10	ANCS4C60X10L	790	2695	£417.50	£501.00
521	11	ANCS4C60X11L	869	2965	£459.25	£551.10
566	12	ANCS4C60X12L	948	3235	£501.00	£601.20
611	13	ANCS4C60X13L	1027	3504	£542.75	£651.30
656	14	ANCS4C60X14L	1106	3774	£584.50	£701.40
701	15	ANCS4C60X15L	1185	4043	£626.25	£751.50
746	16	ANCS4C60X16L	1264	4313	£668.00	£801.60
791	17	ANCS4C60X17L	1343	4582	£709.75	£851.70
836	18	ANCS4C60X18L	1422	4852	£751.50	£901.80
881	19	ANCS4C60X19L	1501	5121	£793.25	£951.90
926	20	ANCS4C60X20L	1580	5391	£835.00	£1,002.00
971	21	ANCS4C60X21L	1659	5661	£876.75	£1,052.10
1016	22	ANCS4C60X22L	1738	5930	£918.50	£1,102.20
1061	23	ANCS4C60X23L	1817	6200	£960.25	£1,152.30
1106	24	ANCS4C60X24L	1896	6469	£1,002.00	£1,202.40
1151	25	ANCS4C60X25L	1975	6739	£1,043.75	£1,252.50
1196	26	ANCS4C60X26L	2054	7008	£1,085.50	£1,302.60
1241	27	ANCS4C60X27L	2133	7278	£1,127.25	£1,352.70
1286	28	ANCS4C60X28L	2212	7547	£1,169.00	£1,402.80
1331	29	ANCS4C60X29L	2291	7817	£1,210.75	£1,452.90
1376	30	ANCS4C60X30L	2370	8086	£1,252.50	£1,503.00
1421	31	ANCS4C60X31L	2449	8356	£1,294.25	£1,553.10
1466	32	ANCS4C60X32L	2528	8626	£1,336.00	£1,603.20
1511	33	ANCS4C60X33L	2607	8895	£1,377.75	£1,653.30
1556	34	ANCS4C60X34L	2686	9165	£1,419.50	£1,703.40
1601	35	ANCS4C60X35L	2765	9434	£1,461.25	£1,753.50
1646	36	ANCS4C60X36L	2844	9704	£1,503.00	£1,803.60
1691	37	ANCS4C60X37L	2923	9973	£1,544.75	£1,853.70
1736	38	ANCS4C60X38L	3002	10243	£1,586.50	£1,903.80
1781	39	ANCS4C60X39L	3081	10512	£1,628.25	£1,953.90
1826	40	ANCS4C60X40L	3160	10782	£1,670.00	£2,004.00

Each radiator will be unique, with the random position of the weld lines on the column tubes and the level of the final sanding.

The clear lacquer allows these characteristics to be the hero and maintains the natural steel finish.



Black weld lines



Sanding marking

#### Optional Slip on welded feet kits

Section & Column Range	No. of Feet	Model	Lacquer Ex VAT	Lacquer Inc VAT
DELIVERY TIMES			48-72 HOURS	
Up to 20 Sections	2	PPANCSSOFKIT2	£97.50	£117.00
21-39 (odd number of sections)	3	PPANCSSOFKIT3	£146.25	£175.50
22-40 (even number of sections)	4	PPANCSSOFKIT4	£195.00	£234.00

100

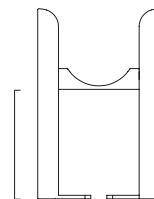

Pipe centres from wall: 2 column = 56mm, 3 column = 74mm, 4 column = 93mm

\*Saving based on the value of individual items when bought separately. Order any of our selected valves and matching pipe covers at the same time as your radiator.

# Ancona® Made to Order shown on pages 18-27

High quality Italian design & manufacture.  
Steel multi column 45mm sections, 2-6 column options  
CE/UKCA approved & certified to BS EN442.



White RAL 9016 as standard, 188 RAL colours and 34 Special Finishes  
Please call **01342 302250** for a RAL or Special Finish chart

Made to Order: Up to 4 weeks White & Colours  
Up to 6 weeks Bare Metal Lacquer,  
Up to 10 weeks Galvanised



**SAVE** WHEN YOU BUY OUR **VINTAGE TRV KIT** WITH ANY ANCONA® ORDER\*  
**£45** QUOTING **PROMOV2** AT TIME OF ORDER

For all Vintage TRV finishes

Create a radiator that matches your exact requirements with thousands of sizes, plus a choice of 188 RAL colours and 34 special finishes available, including bare metal lacquer and galvanised finishes.

## Choose your radiator using our online radiator builder

Once you know your outputs use our online radiator builder to select the best solution for your room. It will take you through the process quickly and easily and allows you to save your ideas to your own Wish List. Go to our **NEW** website [theradiatorcompany.co.uk](http://theradiatorcompany.co.uk)

It is vital to know the correct heat output you need to keep your room warm, use our online BTU (heat output) calculator to get a guide to your requirements which you can then check with your installer.

Build Summary	
Radiator Columns	4
Height & Length	H 600mm x L 971mm
Colour	RAL8024-Beige Brown
Mounting Options	Cast Feet (+100mm to the Height)
Valve	Vintage XL TRV Angled Valves Antique Copper
Lead Time	4 weeks
BTU value of this selection is:	
BTU:	5670
Watts:	1659
Last checked BTU measurement:	
BTU:	6375 - 7650
WATTS:	1875 - 2250
Not sure? <a href="#">Check BTU</a>	
Total price:	<a href="#">Add to Basket</a> <a href="#">Add to Wish List</a>

Once you know your outputs you can use the brochure to specify your radiator by following these steps (or call our Customer Services team on 01342 302250 who will help you size your radiator).

- Note the space you have in mind for the radiator(s) you need; vertical or horizontal, length, height & depth
- Select a column option and height that fits your space; Calculate the number of sections you need by dividing the required BTU (Watt) output with the output per section; e.g 4142 BTUs divided by 205 = 20 sections, based on 3 column, 600mm high sections (always round up to the next whole number of sections).
- If the use of this section size does not work in the available space, try a different column option or if possible a different height.
- Once you have calculated the best number and size of sections, select the best mounting option. Wall hung options (standard wall brackets) are included in your radiator price. Cast feet or welded feet are an additional cost, see kit prices on page 143. Choose your colour from over 200 colours and special finishes; white RAL 9016 or 9010 are our standard finishes.
- Work out the price of your radiator; e.g 3 column 600mm high, white, 20 sections x £33.19 = £663.80 + welded feet kit price £124.80 = £788.60 (inc VAT).
- Place your order with your local Merchant using the Sectional Model Code x No. of Sections needed, noting the Mounting Option and the name and number of the colour you have chosen; e.g ANCO360W x 20 sections, RAL 9016 Traffic white, with welded feet.
- If you have chosen a colour use the colour reference 'R' instead of 'W' and list the colour number and name.

All prices and outputs are given per section in the tables on pages 140-141. Price per section includes plugs, bushes and diverter. Mounting options must be selected separately, these will include the air vent and appropriate number of wall ties.

\*Saving based on the value of individual items when bought separately. Order any of our selected valves and matching pipe covers at the same time as your radiator.

# Ancona® Made to Order - Colours & Special Finishes

The Ancona® made to order range is available in White RAL 9016 as standard (as an alternative the RAL colour 9010 Pure White can be specified at the standard white price). They can also be ordered in one of the 188 RAL colours or any of the non galvanised special finishes including Gun Metal Grey, Textured White and Ivory, Mottled, Metallic and Gold finishes.

Call 01342 302250 for a RAL or special finish chart.



## RAL Colours

Match your room style by selecting from a full rainbow of 188 RAL colours. Use either contrasting colours to create a bold statement or sympathetic colours so your Ancona® blends in to your wall.

## Special Finishes & Bare Metal Lacquer

Choose from colours including metallics, mottled, textured effects as well as a bare metal lacquer, for a Special Finish chart please call our Customer Service team on 01342 302250.



Textured Black Matt



Textured Stone



Mottled Silver



Gun Metal Grey



Mottled Copper



Pearl White



Black Sparkle

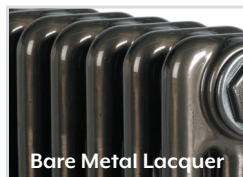

Bare Metal Lacquer

Please specify your chosen RAL number and colour or special finish at time of order.

## Galvanised Finishes

We have developed a range of truly unique, stunning and “on-trend” finishes in classic Antique Copper, Antique Brass and a more contemporary Satin Nickel. We take individual sections of Ancona®, hand-polish every part of the section and then using the hot-dip galvanising process (similar to chroming) we create the finish. 5 stages in total are needed with a final hand brushing and lacquer. The result is distinctive and hardwearing, with each radiator completely unique due to the amount of hand finishing.



Satin Nickel



Antique Brass



Antique Copper

Please note: galvanised Ancona's are available with welded feet only in set sizes, see pages 144-145

## Helpful notes & advice;

Please call us on 01342 302250 if you need any further information or help with specifying your Ancona®.

Ancona® sections are 45mm wide, therefore the total radiator length is; “no. of Sections x 45mm + 26mm for bushes + valves” (Please note due to manufacturing tolerances widths shown may vary by +/- 2mm). When considering the height of your radiator remember that your mounting option will affect the overall height of your radiator. Made To Order Anconas® are supplied factory assembled up to a maximum of 40 sections. For radiators outside these parameters there is an additional joining charge please consult Customer Services to discuss alternative requirements.

® Ancona is a registered trademark of IRSAP UK Limited

# Ancona® Made to Order shown on pages 18-27

Specify your radiator online; Use our **Online Radiator Builder** to quickly and easily specify your radiator.

Go to our website **theradiatorcompany.co.uk**.

Use these tables to specify your radiator by following these steps;

- 1 Calculate the heat output you need for your room, using our online **BTU (Heat Output) Calculator** or check with your installer, remember you may need more than one radiator to heat your room.
- 2 Use the tables below & right to find the best size to suit your space and heat output you need; if you cannot get the right size & output combination from a 2 column radiator try an alternative height or column (depth) option, see page 138 for more details on how to size your radiator.
- 3 Choose the style of mounting option you want; standard wall brackets are included in the radiator price (universal wall brackets for lacquer finishes). If selecting cast feet or welded feet there is an additional cost, see pricing tables on page 143.
- 4 Choose your colour from a choice of 188 RAL colours and 31 special finishes including bare metal lacquer. For galvanised finishes please see pages 144-145.

All prices and outputs are given per section in the tables below. Price per section includes plugs, bushes, diverter, wall brackets and wall ties.

Alternative mounting options must be selected separately, these will include the air vent and appropriate number of wall ties.

Made To Order Anconas® are supplied factory assembled up to a maximum of 40 sections. For radiators outside these parameters, there is an additional joining charge please consult Customer Services to discuss alternative requirements.

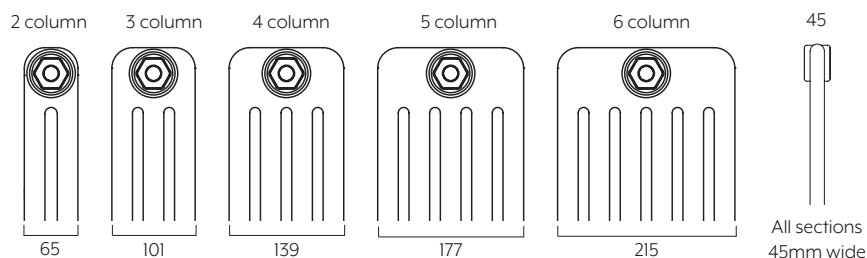

Pipe Centres for all White & Colour Anconas with Cast Feet, Welded Feet or Wall Brackets are;	
Pipe centres left to right = number of sections x 45mm plus 26mm (13mm each) for bushes plus valves. <i>Note due to manufacturing tolerances widths may vary by +/- 2mm.</i>	
Pipe centres from wall (based on adjustable wall ties)	2 Column = 64mm to 74mm 3 Column = 82mm to 92mm 4 Column = 102mm to 112mm 5 Column = 120mm to 130mm 6 Column = 140mm to 150mm

## Sections

### 2 Column - 65mm Deep

Height (mm)	Width (mm)	Model	Watts Δt 50°C	Btu's Δt 50°C	White Ex VAT	White Inc VAT	Colours & Lacquer Ex VAT	Colours & Lacquer Inc VAT	DELIVERY TIMES		
									UP TO 4 WEEKS	4-6 WEEKS	
195	45	ANCO2C19	14	48	£20.83	£25.00	£26.04	£31.25			
300	45	ANCO2C30	23	78	£22.00	£26.40	£27.50	£33.00			
350	45	ANCO2C35	26	89	£22.63	£27.16	£28.29	£33.95			
365	45	ANCO2C36	27	92	£22.73	£27.28	£28.41	£34.09			
400	45	ANCO2C40	30	102	£22.90	£27.48	£28.63	£34.36			
450	45	ANCO2C45	33	113	£23.51	£28.21	£29.39	£35.27			
500	45	ANCO2C50	36	123	£23.69	£28.43	£29.61	£35.53			
550	45	ANCO2C55	39	133	£23.95	£28.74	£29.94	£35.93			
565	45	ANCO2C56	40	136	£24.01	£28.81	£30.01	£36.01			
600	45	ANCO2C60	43	147	£24.17	£29.00	£30.21	£36.25			
650	45	ANCO2C65	46	157	£24.22	£29.06	£30.28	£36.34			
665	45	ANCO2C66	47	160	£24.67	£29.60	£30.84	£37.01			
685	45	ANCO2C68	48	164	£24.96	£29.95	£31.20	£37.44			
750	45	ANCO2C75	52	177	£25.10	£30.12	£31.38	£37.66			
765	45	ANCO2C76	53	181	£26.85	£32.22	£33.56	£40.27			
865	45	ANCO2C86	60	205	£28.03	£33.64	£35.04	£42.05			
885	45	ANCO2C88	61	208	£28.20	£33.84	£35.25	£42.30			
900	45	ANCO2C90	62	212	£28.48	£34.18	£35.60	£42.72			
1000	45	ANCO2C10	69	235	£29.54	£35.45	£36.93	£44.32			
1200	45	ANCO2C12	82	280	£34.51	£41.41	£43.14	£51.77			
1500	45	ANCO2C15	103	351	£41.59	£49.91	£51.99	£62.39			
1800	45	ANCO2C18	124	423	£50.35	£60.42	£62.94	£75.53			
2000	45	ANCO2C20	139	474	£57.13	£68.56	£71.41	£85.69			
2200	45	ANCO2C22	154	525	£62.54	£75.05	£78.18	£93.82			
2500	45	ANCO2C25	177	604	£71.59	£85.91	£89.49	£107.39			

### 3 Column - 101mm Deep

Height (mm)	Width (mm)	Model	Watts Δt 50°C	Btu's Δt 50°C	White Ex VAT	White Inc VAT	Colours & Lacquer Ex VAT	Colours & Lacquer Inc VAT	DELIVERY TIMES		
									UP TO 4 WEEKS	4-6 WEEKS	
195	45	ANCO3C19	20	68	£22.35	£26.82	£27.94	£33.53			
300	45	ANCO3C30	32	109	£24.14	£28.97	£30.18	£36.22			
350	45	ANCO3C35	37	126	£25.19	£30.23	£31.49	£37.79			
365	45	ANCO3C36	38	130	£25.46	£30.55	£31.83	£38.20			
400	45	ANCO3C40	42	143	£26.08	£31.30	£32.60	£39.12			
450	45	ANCO3C45	46	157	£26.85	£32.22	£33.56	£40.27			
500	45	ANCO3C50	51	174	£27.39	£32.87	£34.24	£41.09			
550	45	ANCO3C55	55	188	£27.49	£32.99	£34.36	£41.23			
565	45	ANCO3C56	57	194	£27.61	£33.13	£34.51	£41.41			
600	45	ANCO3C60	60	205	£27.66	£33.19	£34.58	£41.50			
650	45	ANCO3C65	65	222	£28.77	£34.52	£35.96	£43.15			
665	45	ANCO3C66	66	225	£29.21	£35.05	£36.51	£43.81			
685	45	ANCO3C68	68	232	£29.84	£35.81	£37.30	£44.76			
750	45	ANCO3C75	74	252	£30.05	£36.06	£37.56	£45.07			
765	45	ANCO3C76	75	256	£32.99	£39.59	£41.24	£49.49			
865	45	ANCO3C86	84	287	£33.18	£39.82	£41.48	£49.78			
885	45	ANCO3C88	86	293	£33.62	£40.34	£42.03	£50.44			
900	45	ANCO3C90	87	297	£33.89	£40.67	£42.36	£50.83			
1000	45	ANCO3C10	96	328	£35.57	£42.68	£44.46	£53.35			
1200	45	ANCO3C12	114	389	£45.51	£54.61	£56.89	£68.27			
1500	45	ANCO3C15	141	481	£60.76	£72.91	£75.95	£91.14			
1800	45	ANCO3C18	168	573	£65.88	£79.06	£82.35	£98.82			
2000	45	ANCO3C20	187	638	£78.85	£94.62	£98.56	£118.27			
2200	45	ANCO3C22	205	699	£89.24	£107.09	£111.55	£133.86			
2500	45	ANCO3C25	233	795	£96.94	£116.33	£121.18	£145.42			

# Ancona® Made to Order shown on pages 18-27

## 4 Column - 139mm Deep

Height (mm)	Width (mm)	Model	Watts Δt 50°C	Btu's Δt 50°C	White Ex VAT	White Inc VAT	Colours & Lacquer Ex VAT	Colours & Lacquer Inc VAT
DELIVERY TIMES			UP TO 4 WEEKS		4-6 WEEKS			
195	45	ANCO4C19	26	89	£25.02	£30.02	£31.28	£37.54
300	45	ANCO4C30	42	143	£27.29	£32.75	£34.11	£40.93
350	45	ANCO4C35	48	164	£28.03	£33.64	£35.04	£42.05
365	45	ANCO4C36	50	171	£28.48	£34.18	£35.60	£42.72
400	45	ANCO4C40	54	184	£28.66	£34.39	£35.83	£43.00
450	45	ANCO4C45	60	205	£29.82	£35.78	£37.28	£44.74
500	45	ANCO4C50	66	225	£30.76	£36.91	£38.45	£46.14
550	45	ANCO4C55	72	246	£31.94	£38.33	£39.93	£47.92
565	45	ANCO4C56	74	252	£32.57	£39.08	£40.71	£48.85
600	45	ANCO4C60	79	270	£33.40	£40.08	£41.75	£50.10
650	45	ANCO4C65	84	287	£33.79	£40.55	£42.24	£50.69
665	45	ANCO4C66	86	293	£33.86	£40.63	£42.33	£50.80
685	45	ANCO4C68	89	304	£34.15	£40.98	£42.69	£51.23
750	45	ANCO4C75	96	328	£34.26	£41.11	£42.83	£51.40
765	45	ANCO4C76	98	334	£38.30	£45.96	£47.88	£57.46
865	45	ANCO4C86	110	375	£42.23	£50.68	£52.79	£63.35
885	45	ANCO4C88	112	382	£42.66	£51.19	£53.33	£64.00
900	45	ANCO4C90	114	389	£40.98	£49.18	£51.23	£61.48
1000	45	ANCO4C10	125	427	£44.33	£53.20	£55.41	£66.49
1200	45	ANCO4C12	148	505	£56.67	£68.00	£70.84	£85.01
1500	45	ANCO4C15	182	621	£75.22	£90.26	£94.03	£112.84
1800	45	ANCO4C18	216	737	£88.90	£106.68	£111.13	£133.36
2000	45	ANCO4C20	238	812	£98.85	£118.62	£123.56	£148.27
2200	45	ANCO4C22	260	887	£110.64	£132.77	£138.30	£165.96
2500	45	ANCO4C25	292	996	£124.19	£149.03	£155.24	£186.29

## 5 Column - 177mm Deep

Height (mm)	Width (mm)	Model	Watts Δt 50°C	Btu's Δt 50°C	White Ex VAT	White Inc VAT	Colours & Lacquer Ex VAT	Colours & Lacquer Inc VAT
DELIVERY TIMES			UP TO 4 WEEKS		4-6 WEEKS			
195	45	ANCO5C19	31	106	£30.76	£36.91	£38.45	£46.14
300	45	ANCO5C30	51	174	£33.29	£39.95	£41.61	£49.93
350	45	ANCO5C35	59	201	£34.67	£41.60	£43.34	£52.01
365	45	ANCO5C36	61	208	£35.29	£42.35	£44.11	£52.93
400	45	ANCO5C40	66	225	£35.57	£42.68	£44.46	£53.35
450	45	ANCO5C45	73	249	£36.62	£43.94	£45.78	£54.94
500	45	ANCO5C50	81	276	£37.70	£45.24	£47.13	£56.56
550	45	ANCO5C55	88	300	£38.60	£46.32	£48.25	£57.90
565	45	ANCO5C56	90	307	£38.88	£46.66	£48.60	£58.32
600	45	ANCO5C60	95	324	£39.93	£47.92	£49.91	£59.89
650	45	ANCO5C65	103	351	£41.32	£49.58	£51.65	£61.98
665	45	ANCO5C66	105	358	£41.70	£50.04	£52.13	£62.56
685	45	ANCO5C68	108	368	£43.11	£51.73	£53.89	£64.67
750	45	ANCO5C75	117	399	£44.61	£53.53	£55.76	£66.91
765	45	ANCO5C76	119	406	£46.40	£55.68	£58.00	£69.60
865	45	ANCO5C86	133	454	£48.24	£57.89	£60.30	£72.36
885	45	ANCO5C88	136	464	£48.96	£58.75	£61.20	£73.44
900	45	ANCO5C90	138	471	£50.30	£60.36	£62.88	£75.46
1000	45	ANCO5C10	152	519	£53.50	£64.20	£66.88	£80.26
1200	45	ANCO5C12	180	614	£71.14	£85.37	£88.93	£106.72
1500	45	ANCO5C15	220	751	£97.33	£116.80	£121.66	£145.99
1800	45	ANCO5C18	261	891	£115.15	£138.18	£143.94	£172.73
2000	45	ANCO5C20	288	983	£127.84	£153.41	£159.80	£191.76
2200	45	ANCO5C22	314	1071	£141.23	£169.48	£176.54	£211.85
2500	45	ANCO5C25	354	1208	£159.31	£191.17	£199.14	£238.97

## 6 column - 215mm Deep

Height (mm)	Width (mm)	Model	Watts Δt 50°C	Btu's Δt 50°C	White Ex VAT	White Inc VAT	Colours & Lacquer Ex VAT	Colours & Lacquer Inc VAT
DELIVERY TIMES			UP TO 4 WEEKS		4-6 WEEKS			
195	45	ANCO6C19	37	126	£35.75	£42.90	£44.69	£53.63
300	45	ANCO6C30	60	205	£37.26	£44.71	£46.58	£55.90
350	45	ANCO6C35	69	235	£38.88	£46.66	£48.60	£58.32
365	45	ANCO6C36	72	246	£39.82	£47.78	£49.78	£59.74
400	45	ANCO6C40	78	266	£40.28	£48.34	£50.35	£60.42
450	45	ANCO6C45	87	297	£41.32	£49.58	£51.65	£61.98
500	45	ANCO6C50	95	324	£42.23	£50.68	£52.79	£63.35
550	45	ANCO6C55	104	355	£44.73	£53.68	£55.91	£67.09
565	45	ANCO6C56	106	362	£45.34	£54.41	£56.68	£68.02
600	45	ANCO6C60	112	382	£47.92	£57.50	£59.90	£71.88
650	45	ANCO6C65	121	413	£49.87	£59.84	£62.34	£74.81
665	45	ANCO6C66	123	420	£50.49	£60.59	£63.11	£75.73
685	45	ANCO6C68	127	433	£51.54	£61.85	£64.43	£77.32

Height (mm)	Width (mm)	Model	Watts Δt 50°C	Btu's Δt 50°C	White Ex VAT	White Inc VAT	Colours & Lacquer Ex VAT	Colours & Lacquer Inc VAT
DELIVERY TIMES			UP TO 4 WEEKS		4-6 WEEKS			
750	45	ANCO6C75	137	467	£52.16	£62.59	£65.20	£78.24
765	45	ANCO6C76	140	478	£53.33	£64.00	£66.66	£79.99
865	45	ANCO6C86	156	532	£56.07	£67.28	£70.09	£84.11
885	45	ANCO6C88	160	546	£57.13	£68.56	£71.41	£85.69
900	45	ANCO6C90	162	553	£58.02	£69.62	£72.53	£87.04
1000	45	ANCO6C10	178	607	£62.72	£75.26	£78.40	£94.08
1200	45	ANCO6C12	211	720	£83.93	£100.72	£104.91	£125.89
1500	45	ANCO6C15	259	884	£115.61	£138.73	£144.51	£173.41
1800	45	ANCO6C18	306	1044	£136.71	£164.05	£170.89	£205.07
2000	45	ANCO6C20	337	1150	£147.42	£176.90	£184.28	£221.14
2200	45	ANCO6C22	369	1259	£170.17	£204.20	£212.71	£255.25
2500	45	ANCO6C25	416	1419	£194.27	£233.12	£242.84	£291.41

® Ancona is a registered trademark of IRSAP UK Limited

\*Saving based on the value of individual items when bought separately. Order any of our selected valves and matching pipe covers at the same time as your radiator.

# Ancona® Made to Order - Wall Brackets

Once you have chosen your radiator size you can choose any one of our 3 mounting options & specify at time of order (fittings are available to order with a corresponding radiator only).

Standard wall brackets are included in your radiator price. The correct number of brackets and wall ties will be supplied with each order; prices for extra wall brackets and wall ties are available on request, please call **01342 302250**.

Technical & pipe centre information of each mounting option is shown below / right.

Please note: Anconas® in a bare metal lacquer finish are only available to be mounted with universal wall brackets or welded feet.



\*PPANCOWNB

## Standard wall brackets technical & pipe centre information (suitable for stud walls) (appropriate for all finishes except Bare Metal Lacquer)

Can be positioned at any height (minimum height from floor 100mm); brackets are supplied with raw plugs.

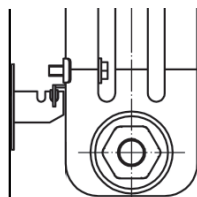

Pipe centres from wall:  
 2 column = 64mm - 74mm  
 3 column = 82mm - 92mm  
 4 column = 102mm - 112mm  
 5 column = 120mm - 130mm  
 6 column = 140mm - 150mm



Wall tie; adjustable from 32mm to 42mm



\*PPANCOWNB

## Bare metal lacquer universal wall brackets (suitable for stud walls)

Note: Ancona's with lacquer wall brackets can be positioned at any height (minimum 100mm from floor)

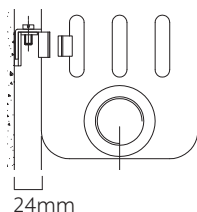

Pipe centres from wall:  
 2 column = 56mm  
 3 column = 74mm  
 4 column = 93mm  
 5 column = 112mm  
 6 column = 131mm

## Build your radiator using our online radiator builder on our new and improved website

It is vital to know the correct heat output you need to keep your room warm, use our **online BTU (heat output) calculator** to get a guide to your requirements which you can then check with your installer.

Once you know your outputs use our **online radiator builder** to select the best solution for your room. It will take you through the process quickly and easily and allows you to save your ideas to your own Wish List. Please go to our website **theradiatorcompany.co.uk**

## Optional Solid Brass Wall Ties & Airvents New

These solid brass wall ties provide a stylish finishing touch to any Ancona® radiator; select to match your valves. Available as a kit including matching airvent in Antique Brass, Chrome, Polished Brass and Brushed Nickel.

Please note that these wall ties and airvents are an optional extra and do not come as standard with your Ancona® radiator.

Description	Model	Number of Wall Ties	Number of Airvents	Number of Blank Plugs	Price Ex VAT	Price Inc VAT
DELIVERY TIMES					48-72 HOURS	
Single Wall Tie	PPANWT	1	N/A	N/A	£64.00	£76.80
Single Airvent & Blank Plug	PPLAVBP	N/A	1	1	£18.00	£21.60
Wall Tie, Airvent & Blank Plug Kit	PPANWTAVKIT2	2	1	1	£140.00	£168.00
Wall Tie, Airvent & Blank Plug Kit	PPANWTAVKIT3	3	1	1	£198.00	£237.60
Wall Tie, Airvent & Blank Plug Kit	PPANWTAVKIT4	4	1	1	£258.00	£309.60
Wall Tie, Airvent & Blank Plug Kit	PPANWTAVKIT5	5	1	1	£318.00	£381.60

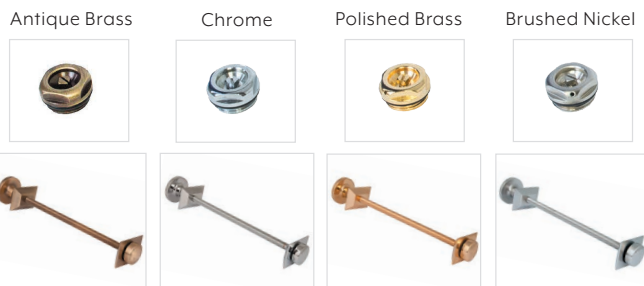

Please specify your finish at time of order.

# Ancona® Made to Order - Floor Mounting Options

Once you have chosen your radiator size you can choose to have your Ancona® floor mounted by selecting either Welded or Cast feet (fittings are available to order with a corresponding radiator only).

**Please note; Welded feet and Cast Feet are an additional cost to your radiator price.**

The correct number of wall ties will be supplied with each order; prices for extra cast feet and wall ties are available on request, please call **01342 302250**.

Please specify your preferred floor mounting option & kit number at time of order.

Technical & pipe centre information of each mounting option is shown below.

## Cast feet kit prices

**Note: please remember to add 100mm to the height of the Ancona® section you have chosen if you are using cast feet.**

Section & Column Range	No. of Feet	Model	White Ex VAT	White Inc VAT	Colours Ex VAT	Colours Inc VAT
DELIVERY TIMES			UP TO 4 WEEKS		UP TO 4 WEEKS	
2-20 Sections / 2-6 Columns	2	PPANCOCFKIT2	£54.00	£64.80	£67.50	£81.00
21-30 Sections / 2-6 Columns	3	PPANCOCFKIT3	£81.00	£97.20	£101.25	£121.50
31-40 Sections / 2-6 Columns	4	PPANCOCFKIT4	£108.00	£129.60	£135.00	£162.00

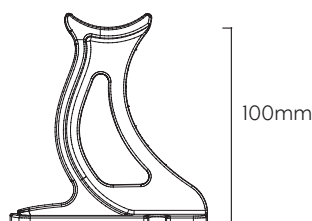

## Cast Feet pipe centres



Pipe centres from wall:  
 2 column = 64mm - 74mm  
 3 column = 82mm - 92mm  
 4 column = 102mm - 112mm  
 5 column = 120mm - 130mm  
 6 column = 140mm - 150mm



Wall tie; adjustable from 32mm to 42mm

*Please note: cast feet are not available for bare metal lacquer finishes*

\*PPANCOCFK

## Welded feet kit prices

**Note: Please remember to add 97mm to the height of the Ancona® section you have chosen if you are using welded feet.**

Sections	No. of Feet	Model	White Ex VAT	White Inc VAT	Colours & Lacquer Ex VAT	Colours & Lacquer Inc VAT
DELIVERY TIMES			UP TO 4 WEEKS		4-6 WEEKS	
Up to 20 Sections	2	PPANCOWFKIT2	£104.00	£124.80	£130.00	£156.00
21-39 (odd number of sections)	3	PPANCOWFKIT3	£156.00	£187.20	£195.00	£234.00
22-40 (even number of sections)	4	PPANCOWFKIT4	£208.00	£249.60	£260.00	£312.00

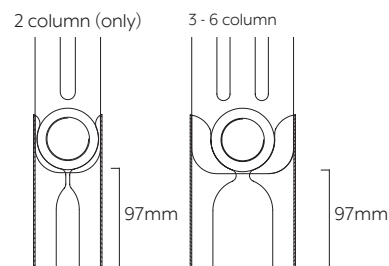

## White & colour welded feet pipe centres

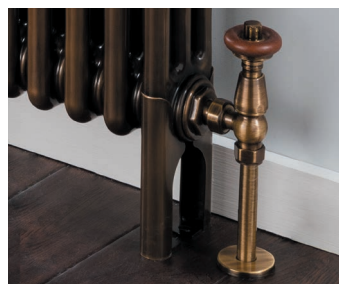

Pipe centres from wall:  
 2 column = 64mm - 74mm  
 3 column = 82mm - 92mm  
 4 column = 102mm - 112mm  
 5 column = 120mm - 130mm  
 6 column = 140mm - 150mm

\*PPANCOWF

## Bare metal lacquer welded feet pipe centres



Pipe centres from wall:  
 2 column = 56mm  
 3 column = 74mm  
 4 column = 93mm  
 5 column = 112mm  
 6 column = 131mm

\*PPANCOWF

Anconas® with welded feet are supplied with the correct number of feet (see above); additional welded feet cannot be ordered.

# Ancona® Galvanised shown on pages 26-27

High quality Italian design & manufacture  
Steel multi column; 2, 3 & 4 column options with welded feet only  
CE/UKCA approved & certified to BS EN442

Galvanised Antique Brass  
Galvanised Antique Copper  
Galvanised Satin Nickel

Made to Order: Up to 10 weeks



Galvanised Antique Bronze



Vintage TRV Kit

**SAVE** WHEN YOU BUY OUR **VINTAGE TRV KIT** WITH ANY ANCONA® ORDER\*  
**£45** QUOTING **PROMOV2** AT TIME OF ORDER

For all Vintage TRV finishes

## 2 Column

2 column

Pipe Centres for all Anconas Welded Feet;	
Pipe centres left to right = width + valves Please note that due to manufacturing tolerances widths shown may vary by +/- 2mm.	
Pipe centres from wall (based on adjustable wall ties)	2 Column = 64mm to 74mm

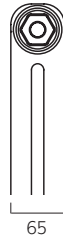

**Please note; radiator heights include welded feet.**

## 2 Column horizontal

Height (mm)	Width (mm)	Sections	Model	Watts Δt 50°C	Btu's Δt 50°C	Price Ex VAT	Price Inc VAT
DELIVERY TIMES				UP TO 10 WEEKS			
597	611	13	ANCO2C13S50	446	1522	£2,734.00	£3,280.80
	701	15	ANCO2C15S50	515	1757	£3,193.00	£3,831.60
	836	18	ANCO2C18S50	617	2105	£3,837.00	£4,604.40
	1016	22	ANCO2C22S50	755	2576	£4,687.00	£5,624.40
697	611	13	ANCO2C13S60	525	1791	£2,878.00	£3,453.60
	701	15	ANCO2C15S60	606	2068	£3,345.00	£4,014.00
	836	18	ANCO2C18S60	727	2481	£4,018.00	£4,821.60
	1016	22	ANCO2C22S60	889	3033	£4,895.00	£5,874.00

Please specify your Galvanised finish at time of order



Galvanised Satin Nickel

## 2 Column vertical

Height (mm)	Width (mm)	Sections	Model	Watts Δt 50°C	Btu's Δt 50°C	Price Ex VAT	Price Inc VAT
DELIVERY TIMES				UP TO 10 WEEKS			
1897	386	8	ANCO2C08S18	932	3180	£2,594.00	£3,112.80
	476	10	ANCO2C10S18	1165	3975	£3,147.00	£3,776.40
	566	12	ANCO2C12S18	1398	4770	£3,633.00	£4,359.60
2097	386	8	ANCO2C08S20	1042	3555	£2,604.00	£3,124.80
	476	10	ANCO2C10S20	1302	4442	£3,145.00	£3,774.00
	566	12	ANCO2C12S20	1562	5330	£3,562.00	£4,274.40

Please specify your Galvanised finish at time of order

2 column (only)

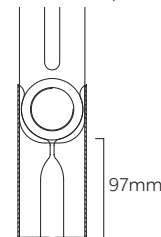

**Please note; radiator heights include welded feet.**

® Ancona is a registered trademark of IRSAP UK Limited

\*Saving based on the value of individual items when bought separately. Order any of our selected valves and matching pipe covers at the same time as your radiator.



### 3 Column

Pipe Centres for all Anconas Welded Feet;	
Pipe centres left to right = width + valves Please note due to manufacturing tolerances widths shown may vary by +/- 2mm	
Pipe centres from wall (based on adjustable wall ties)	3 Column = 82mm to 92mm

3 column

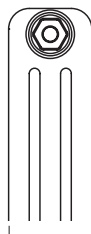

101

**Please note; radiator heights include welded feet.**

### 3 Column horizontal

Height (mm)	Width (mm)	Sections	Model	Watts Δt 50°C	Btu's Δt 50°C	Price Ex VAT	Price Inc VAT
DELIVERY TIMES				UP TO 10 WEEKS			
597	611	13	ANCO3C13S50	611	2085	£2,861.00	£3,433.20
	701	15	ANCO3C15S50	705	2405	£3,290.00	£3,948.00
	836	18	ANCO3C18S50	846	2887	£3,951.00	£4,741.20
	1016	22	ANCO3C22S50	1034	3528	£4,829.00	£5,794.80
697	611	13	ANCO3C13S60	720	2457	£3,000.00	£3,600.00
	701	15	ANCO3C15S60	831	2835	£3,449.00	£4,138.80
	836	18	ANCO3C18S60	997	3402	£4,141.00	£4,969.20
	1016	22	ANCO3C22S60	1219	4159	£5,043.00	£6,051.60

Please specify your Galvanised finish at time of order

### 3 Column vertical

Height (mm)	Width (mm)	Sections	Model	Watts Δt 50°C	Btu's Δt 50°C	Price Ex VAT	Price Inc VAT
DELIVERY TIMES				UP TO 10 WEEKS			
1897	386	8	ANCO3C08S18	1235	4214	£2,693.00	£3,231.60
	476	10	ANCO3C10S18	1544	5268	£3,222.00	£3,866.40
	566	12	ANCO3C12S18	1853	6322	£3,744.00	£4,492.80
2097	386	8	ANCO3C08S20	1369	4671	£2,726.00	£3,271.20
	476	10	ANCO3C10S20	1711	5838	£3,248.00	£3,897.60
	566	12	ANCO3C12S20	2053	7005	£3,758.00	£4,509.60

Please specify your Galvanised finish at time of order



Galvanised Antique Copper

### 4 Column

Pipe Centres for all Anconas Welded Feet;	
Pipe centres left to right = width + valves Please note due to manufacturing tolerances widths shown may vary by +/- 2mm	
Pipe centres from wall (based on adjustable wall ties)	4 Column = 102mm to 112mm

4 column

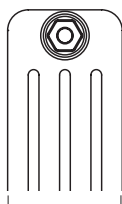

139

3 - 4 column

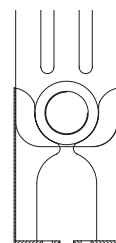

97mm

**Please note; radiator heights include welded feet.**

**Please note; radiator heights include welded feet.**

### 4 Column horizontal

Height (mm)	Width (mm)	Sections	Model	Watts Δt 50°C	Btu's Δt 50°C	Price Ex VAT	Price Inc VAT
DELIVERY TIMES				UP TO 10 WEEKS			
597	611	13	ANCO4C13S50	806	2750	£3,005.00	£3,606.00
	701	15	ANCO4C15S50	930	3173	£3,454.00	£4,144.80
	836	18	ANCO4C18S50	1116	3808	£4,149.00	£4,978.80
	1016	22	ANCO4C22S50	1364	4654	£5,070.00	£6,084.00
697	611	13	ANCO4C13S60	952	3248	£3,148.00	£3,777.60
	701	15	ANCO4C15S60	1098	3746	£3,622.00	£4,346.40
	836	18	ANCO4C18S60	1318	4497	£4,347.00	£5,216.40
	1016	22	ANCO4C22S60	1610	5493	£5,297.00	£6,356.40

Please specify your Galvanised finish at time of order

### 4 Column vertical

Height (mm)	Width (mm)	Sections	Model	Watts Δt 50°C	Btu's Δt 50°C	Price Ex VAT	Price Inc VAT
DELIVERY TIMES				UP TO 10 WEEKS			
1897	386	8	ANCO4C08S18	1602	5466	£2,829.00	£3,394.80
	476	10	ANCO4C10S18	2003	6834	£3,382.00	£4,058.40
	566	12	ANCO4C12S18	2404	8202	£3,931.00	£4,717.20
2097	386	8	ANCO4C08S20	1766	6026	£2,860.00	£3,432.00
	476	10	ANCO4C10S20	2207	7530	£3,411.00	£4,093.20
	566	12	ANCO4C12S20	2648	9035	£3,949.00	£4,738.80

Please specify your Galvanised finish at time of order

# Ancona® Bench Seat Horizontal page 28

High quality Italian design and manufacture  
Steel multi column supplied with a wooden seat  
CE/UKCA approved & certified to BS EN442



White RAL 9016 as standard, 188 RAL colours and 30 Special Finishes  
Please call **01342 302250** for a RAL or Special Finish chart

Made to Order: Up to 4 weeks White & Colours



**SAVE £45** WHEN YOU BUY OUR **VINTAGE TRV KIT** WITH ANY ANCONA® ORDER\* QUOTING **PROMOV2** AT TIME OF ORDER

For all Vintage TRV finishes

Height A (mm)	Radiator Width B (mm)	Bench Seat Width C (mm)	Columns	Sections	Model	Watts Δt 50°C	Btu's Δt 50°C	White Ex VAT	White Inc VAT	Colours Ex VAT	Colours Inc VAT
DELIVERY TIMES											
								UP TO 4 WEEKS		UP TO 4 WEEKS	
460	502	650	6	4	ANCB4S4665	383	1307	£1,466.00	£1,759.20	£1,832.50	£2,199.00
	667	815			ANCB4S4681	495	1689	£1,660.00	£1,992.00	£2,075.00	£2,490.00
	867	1015			ANCB4S4610	628	2143	£1,876.00	£2,251.20	£2,345.00	£2,814.00
	1202	1350			ANCB4S4613	845	2883	£2,073.00	£2,487.60	£2,591.25	£3,109.50
	1502	1650			ANCB4S4616	1036	3535	£2,266.00	£2,719.20	£2,832.50	£3,399.00
	1802	1950			ANCB4S4619	1226	4183	£2,417.00	£2,900.40	£3,021.25	£3,625.50
	2002	2150			ANCB4S4621	1352	4613	£2,544.00	£3,052.80	£3,180.00	£3,816.00
	2202	2350			ANCB4S4623	1477	5040	£2,782.00	£3,338.40	£3,477.50	£4,173.00
	2502	2650			ANCB4S4626	1665	5681	£2,889.00	£3,466.80	£3,611.25	£4,333.50
460	502	650	6	5	ANCB5S4665	479	1634	£1,509.00	£1,810.80	£1,886.25	£2,263.50
	667	815			ANCB5S4681	619	2112	£1,712.00	£2,054.40	£2,140.00	£2,568.00
	867	1015			ANCB5S4610	785	2678	£1,940.00	£2,328.00	£2,425.00	£2,910.00
	1202	1350			ANCB5S4613	1056	3603	£2,151.00	£2,581.20	£2,688.75	£3,226.50
	1502	1650			ANCB5S4616	1296	4422	£2,372.00	£2,846.40	£2,965.00	£3,558.00
	1802	1950			ANCB5S4619	1533	5231	£2,478.00	£2,973.60	£3,097.50	£3,717.00
	2002	2150			ANCB5S4621	1690	5766	£2,606.00	£3,127.20	£3,257.50	£3,909.00
	2202	2350			ANCB5S4623	1847	6302	£2,854.00	£3,424.80	£3,567.50	£4,281.00
	2502	2650			ANCB5S4626	2081	7100	£2,990.00	£3,588.00	£3,737.50	£4,485.00
505	502	650	6	6	ANCB6S5065	575	1962	£1,554.00	£1,864.80	£1,942.50	£2,331.00
	667	815			ANCB6S5081	742	2532	£1,765.00	£2,118.00	£2,206.25	£2,647.50
	867	1015			ANCB6S5010	941	3211	£1,997.00	£2,396.40	£2,496.25	£2,995.50
	1202	1350			ANCB6S5013	1267	4323	£2,239.00	£2,686.80	£2,798.75	£3,358.50
	1502	1650			ANCB6S5016	1555	5306	£2,490.00	£2,988.00	£3,112.50	£3,735.00
	1802	1950			ANCB6S5019	1839	6275	£2,618.00	£3,141.60	£3,272.50	£3,927.00
	2002	2150			ANCB6S5021	2027	6916	£2,752.00	£3,302.40	£3,440.00	£4,128.00
	2202	2350			ANCB6S5023	2216	7561	£3,027.00	£3,632.40	£3,783.75	£4,540.50
	2502	2650			ANCB6S5026	2497	8520	£3,187.00	£3,824.40	£3,983.75	£4,780.50

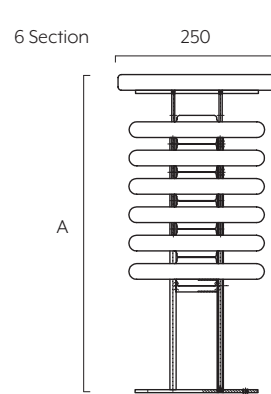
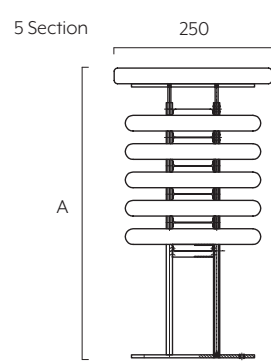
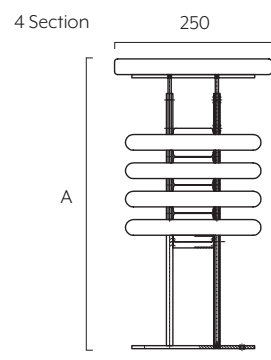

All prices shown include wooden seat.

**Please note: Bench seats over 1650mm wide will be supplied with 3 feet.**

Pipe centres = width (B) - 67mm

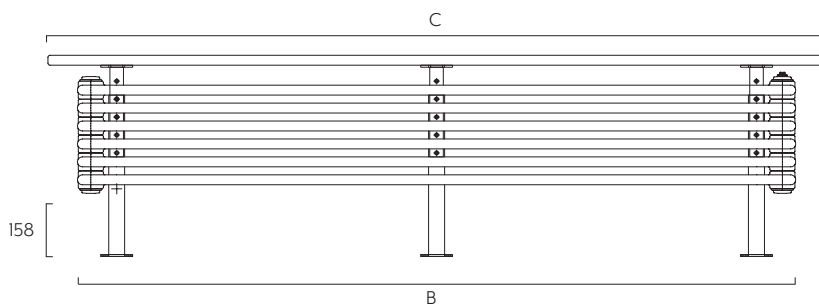

\*Saving based on the value of individual items when bought separately. Order any of our selected valves and matching pipe covers at the same time as your radiator.

# Ancona® Bench Seat Vertical page 29

High quality Italian design and manufacture  
Steel multi column supplied with a wooden seat  
CE/UKCA approved & certified to BS EN442.



White RAL 9016 as standard, 188 RAL colours and 30 Special Finishes  
Please call **01342 302250** for a RAL or Special Finish chart

Made to Order: Up to 5 weeks White & Colours



**SAVE** WHEN YOU BUY OUR **VINTAGE TRV KIT** WITH ANY ANCONA® ORDER\*  
**£45** QUOTING **PROMOV2** AT TIME OF ORDER

For all Vintage TRV finishes

Height A (mm)	Radiator Width B (mm)	Bench Seat Width C (mm)	Columns	Sections	Model	Watts Δt 50°C	Btu's Δt 50°C	White Ex VAT	White Inc VAT	Colours Ex VAT	Colours Inc VAT
DELIVERY TIMES											
						UP TO 5 WEEKS			UP TO 5 WEEKS		
496	1016	1350	4	22	ANCB4C22S	926	3160	£1,094.00	£1,312.80	£1,367.50	£1,641.00
	1286	1650		28	ANCB4C28S	1179	4023	£1,200.00	£1,440.00	£1,500.00	£1,800.00
	1466	1650		32	ANCB4C32S	1347	4596	£1,305.00	£1,566.00	£1,631.25	£1,957.50
	1646	1950		36	ANCB4C36S	1516	5173	£1,376.00	£1,651.20	£1,720.00	£2,064.00
	1736	1950		38	ANCB4C38S	1600	5459	£1,455.00	£1,746.00	£1,818.75	£2,182.50
	2051	2150		45	ANCB4C45S	1895	6466	£1,646.00	£1,975.20	£2,057.50	£2,469.00
	2366	2650		52	ANCB4C52S	2189	7469	£1,856.00	£2,227.20	£2,320.00	£2,784.00
	1016	1350		5	22	ANCB5C22S	1131	3859	£1,155.00	£1,386.00	£1,443.75
	1286	1650	28		ANCB5C28S	1439	4910	£1,276.00	£1,531.20	£1,595.00	£1,914.00
	1466	1650	32		ANCB5C32S	1645	5613	£1,392.00	£1,670.40	£1,740.00	£2,088.00
	1646	1950	36		ANCB5C36S	1850	6312	£1,474.00	£1,768.80	£1,842.50	£2,211.00
	1736	1950	38		ANCB5C38S	1953	6664	£1,560.00	£1,872.00	£1,950.00	£2,340.00
	2051	2150	45		ANCB5C45S	2313	7892	£1,769.00	£2,122.80	£2,211.25	£2,653.50
	2366	2650	52		ANCB5C52S	2673	9120	£2,000.00	£2,400.00	£2,500.00	£3,000.00
	1016	1350	6		22	ANCB6C22S	1335	4555	£1,230.00	£1,476.00	£1,537.50
	1286	1650		28	ANCB6C28S	1700	5800	£1,372.00	£1,646.40	£1,715.00	£2,058.00
	1466	1650		32	ANCB6C32S	1942	6626	£1,499.00	£1,798.80	£1,873.75	£2,248.50
	1646	1950		36	ANCB6C36S	2185	7455	£1,596.00	£1,915.20	£1,995.00	£2,394.00
	1736	1950		38	ANCB6C38S	2307	7871	£1,686.00	£2,023.20	£2,107.50	£2,529.00
	2051	2150		45	ANCB6C45S	2732	9322	£1,984.00	£2,380.80	£2,480.00	£2,976.00
	2366	2650		52	ANCB6C52S	3156	10768	£2,237.00	£2,684.40	£2,796.25	£3,355.50

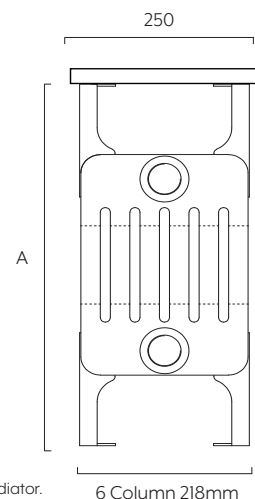
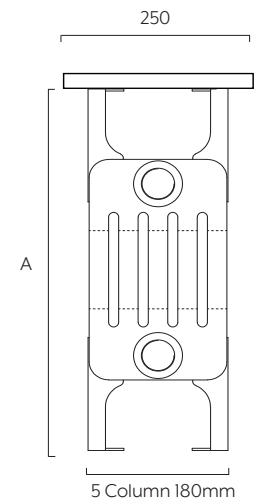
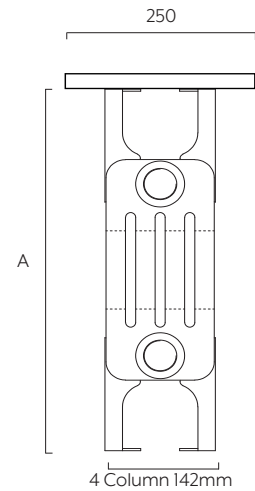

All prices shown include wooden seat. Please note height (A) does not include wooden seat.

**Please note: Bench seats 1286mm wide and over will be supplied with 4 feet.**

Pipe centres = width of radiator (B) + valves  
Due to manufacturing tolerances widths may vary by +/- 2mm.

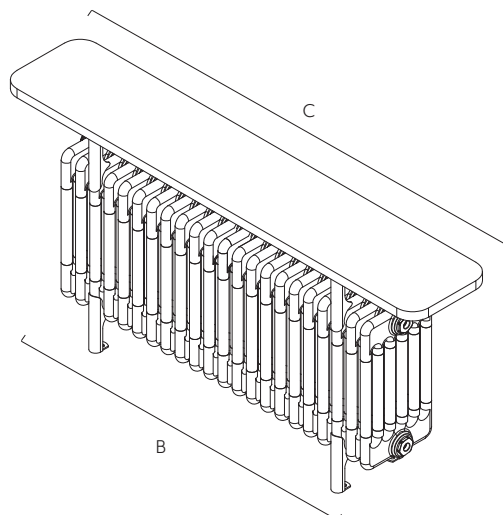
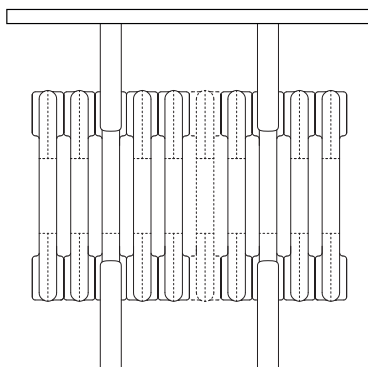

\*Saving based on the value of individual items when bought separately. Order any of our selected valves & matching pipe covers at the same time as your radiator.

# Ancona® Curved shown on page 30



High quality Italian design & manufacture

Steel Multi Column; 2, 3 & 4 column options with wall brackets or optional welded feet  
CE/UKCA approved & certified to BS EN442.

White RAL 9016 as standard, 188 RAL colours and 30 Special Finishes

Please call **01342 302250** for a RAL or Special Finish chart

Approximately 6 weeks from receipt of written sign off of technical drawings

Visit our website for further information [theradiatorcompany.co.uk](http://theradiatorcompany.co.uk).



**SAVE £45** WHEN YOU BUY OUR **VINTAGE TRV KIT** WITH ANY ANCONA® ORDER\*  
QUOTING **PROMOV2** AT TIME OF ORDER

For all Vintage TRV finishes

Our Ancona® radiators can be curved to fit bay windows and around columns.

Alternative heights are available on request, please contact us on **01342 302250** if required.

Radiators can be curved using up to 40 sections, minimum 10 sections (450mm).

As with all radiators, it is essential to know how much heat you need to keep your room comfortable, use our online Heat Output Calculator to work out how much heat you will need for your room before you size your radiator.

Curving is a precise process and as such accurate measurements and calculations must be made and checked before production can begin. Since our Ancona® Curved is made on a bespoke basis to your exact requirements, we have created an online tool to help make the process as easy as possible;

To order your curved radiator follow these simple steps;

- 1 Go to our website [theradiatorcompany.co.uk](http://theradiatorcompany.co.uk) and select the 'Curved Ancona®' in the steel multi column section, download or read the specification document which explains how to measure for your curved radiator
- 2 Use our online Curved Radiator Builder by filling in all the sections
- 3 When you have reviewed the technical specification, double-check everything is correct to see how your radiator will fit in your space
- 4 Print the technical specification and sign all pages once you are happy with the details
- 5 Use the signed specification to place your order with your Installer or local merchant

Alternatively, you can complete the Specification Instruction sheet with the dimensions of your bay or column and return it to us via email, fax or post (please see contact details below). However, this will take extra time for us to have drawings made and then sent to you for approval before any order can be placed.

**Please note; once you have signed off your drawings and ordered your curved radiator it cannot be cancelled or returned.**

## Ancona® Curved 2 column (output by section)

Height (mm)	Model	Watts Δt 50°C	Btu's Δt 50°C	White Ex VAT	White Inc VAT	Colours Ex VAT	Colours Inc VAT
DELIVERY TIMES		6 WEEKS FROM SIGN OFF					
300	ANCC2C30	23	78	£45.95	£55.14	£51.45	£61.74
400	ANCC2C40	30	102	£46.85	£56.22	£52.58	£63.10
500	ANCC2C50	36	123	£47.64	£57.17	£53.56	£64.27
600	ANCC2C60	43	147	£48.12	£57.74	£54.16	£64.99
750	ANCC2C75	52	177	£49.05	£58.86	£55.33	£66.40

Internal Ancona® Curved

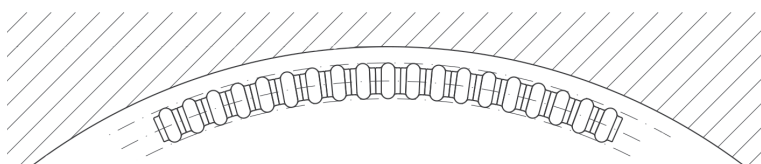

## Ancona® Curved 3 column (output by section)

Height (mm)	Model	Watts Δt 50°C	Btu's Δt 50°C	White Ex VAT	White Inc VAT	Colours Ex VAT	Colours Inc VAT
DELIVERY TIMES		6 WEEKS FROM SIGN OFF					
300	ANCC3C30	32	109	£48.09	£57.71	£54.13	£64.96
400	ANCC3C40	42	143	£50.03	£60.04	£56.55	£67.86
500	ANCC3C50	51	174	£51.34	£61.61	£58.19	£69.83
600	ANCC3C60	60	205	£51.61	£61.93	£58.53	£70.24
750	ANCC3C75	74	252	£54.00	£64.80	£61.51	£73.81

## Kits for welded feet

**Note: Please remember to add 97mm to the height of the Ancona section you have chosen if you are using welded feet.**

## Ancona® Curved 4 column (output by section)

Height (mm)	Model	Watts Δt 50°C	Btu's Δt 50°C	White Ex VAT	White Inc VAT	Colours Ex VAT	Colours Inc VAT
DELIVERY TIMES		6 WEEKS FROM SIGN OFF					
300	ANCC4C30	42	143	£51.24	£61.49	£58.06	£69.67
400	ANCC4C40	54	184	£52.61	£63.13	£59.78	£71.74
500	ANCC4C50	66	225	£54.71	£65.65	£62.40	£74.88
600	ANCC4C60	79	270	£57.35	£68.82	£65.70	£78.84
750	ANCC4C75	96	328	£58.21	£69.85	£66.78	£80.14

Sections	Model	No. of Feet	White Ex VAT	White Inc VAT	Colours Ex VAT	Colours Inc VAT
DELIVERY TIMES		6 WEEKS FROM SIGN OFF				
Up to 20 Sections	PPANCOWFKIT2	2	£104.00	£124.80	£130.00	£156.00
21-39 (odd number of sections)	PPANCOWFKIT3	3	£156.00	£187.20	£195.00	£234.00
22-40 (even number of sections)	PPANCOWFKIT4	4	£208.00	£249.60	£260.00	£312.00

\*Saving based on the value of individual items when bought separately.

Order any of our selected valves and matching pipe covers at the same time as your radiator.

# Ancona<sup>®</sup> Electric shown on page 31



High quality Italian design & manufacture  
 Steel Multi Column 3 column with wall brackets only  
 Eco Design  
 10 year guarantee on the radiator  
 2 year guarantee on the element

White RAL 9016

**Stock Sizes: 48-72 Hours**

Made to Order Sizes: Up to 5 weeks



The Ancona electric ranges combine the classic Ancona design with the flexibility of a fully controllable electric element. Offering 8 function modes, the Ancona Electric can be set to operate when you wish, on a daily basis, or you can select one of the three pre-set programmes. The Open Window Function detects an open external door or window and will turn the radiator off if it detects that it is allowing heat to escape, saving energy and money.

## Stock options White RAL 9016 New

Height (mm)	Width B (mm)	Sections	Model	Watts $\Delta t$ 50°C	White Ex VAT	White Inc VAT
DELIVERY TIMES				48-72 HOURS		
600	708	14	ANCO3C6063EW	800	£761.00	£913.20
	843	17	ANCO3C6076EW	1000	£812.00	£974.40
	978	20	ANCO3C6090EW	1200	£863.00	£1,035.60
	1113	23	ANCO3C6010EW	1500	£911.00	£1,093.20



Made to order options

Height (mm)	Width B (mm)	Sections	Model	Watts $\Delta t$ 50°C	White Ex VAT	White Inc VAT
DELIVERY TIMES				UP TO 5 WEEKS		
600	439	8	ANCO3C6036EW	400	£665.00	£798.00
	618	12	ANCO3C6054EW	600	£726.00	£871.20
	1383	29	ANCO3C6013EW	2000	£1,005.00	£1,206.00

- IP24
- 8 operating modes: weekly program, 3 integrated pre-set timed programs, pilot-wire facility, comfort, night and antifreeze.
- Open Window Function
- Comfort, Night and Antifreeze
- 2 Year Guarantee on the element

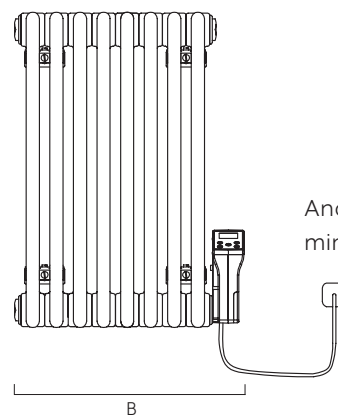
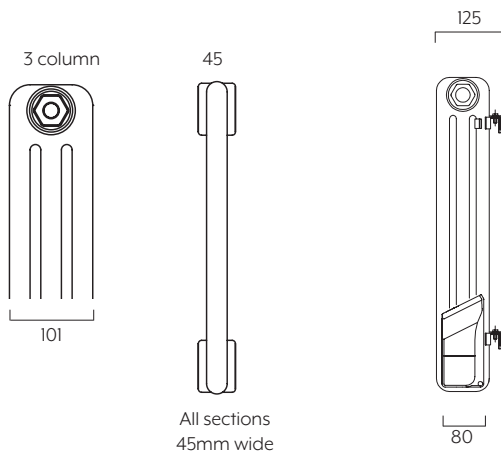

# Ceramica Collection shown on pages 34-35

High quality Italian design & manufacture.

Recycled Marble radiant panels

Hydronic or Electric versions available

White finish only; choose from 3 different designs - Varenna, Pavia or Senso

All hydronic versions come complete with our 'hidden valve' system including thermostatic valves and flexi hoses

Electric versions; Class II IPX24 with fully programmable digital control

Delivered in up to 6 weeks



Pipe centres	Depth from wall
Pipes come directly out of the wall, 60mm apart.	74mm

Made to order options - Hydronic Vertical

Height (mm)	Width (mm)	Model	Watts $\Delta t$ 50°C	Btu's $\Delta t$ 50°C	White Ex VAT	White Inc VAT
DELIVERY TIMES					UP TO 6 WEEKS	
1100	550	CERAV1155	720	2457	£1,809.00	£2,170.80
1500	550	CERAV1555	1200	4094	£2,045.00	£2,454.00
1800	300	CERAV1830	480	1638	£1,792.00	£2,150.40
	550	CERAV1855	1680	5732	£2,187.00	£2,624.40

Please make sure you specify your finish at time of order; Senso, Varenna or Pavia (shown right)

Made to order options - Hydronic Horizontal

Height (mm)	Width (mm)	Model	Watts $\Delta t$ 50°C	Btu's $\Delta t$ 50°C	White Ex VAT	White Inc VAT
DELIVERY TIMES					UP TO 6 WEEKS	
550	860	CERAH5586	600	2047	£1,738.00	£2,085.60
	1100	CERAH5511	720	2457	£1,870.00	£2,244.00

Please make sure you specify your finish at time of order; Senso, Varenna or Pavia

- Senso - simple and plain, a lightly textured effect creating an understated statement.
- Varenna- a sense of movement created by the interaction of light and shade across the soft lines and gentle curves of the design.
- Pavia - a natural stone effect finish with a strong bold impact.

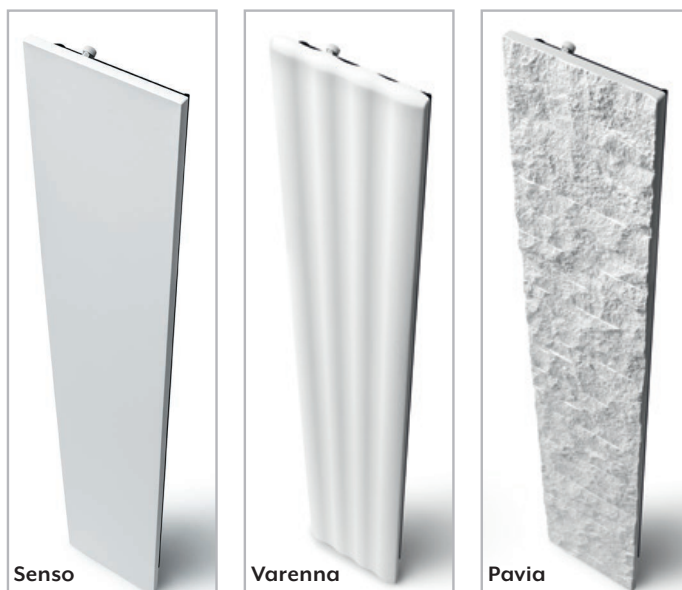

**Please Note: These radiators are very heavy and will require at least two people to lift and fit.**

Made to order options - Electric Vertical

Height (mm)	Width (mm)	Model	Watts $\Delta t$ 50°C	White Ex VAT	White Inc VAT
DELIVERY TIMES					UP TO 6 WEEKS
550	860	CERAH5586E	500	£1,616.00	£1,939.20
	1100	CERAH5511E	750	£1,706.00	£2,047.20

Please make sure you specify your finish at time of order; Senso, Varenna or Pavia

Made to order options - Electric Vertical

Height (mm)	Width (mm)	Model	Watts $\Delta t$ 50°C	White Ex VAT	White Inc VAT
DELIVERY TIMES					UP TO 6 WEEKS
1000	300	CERAV1030E	250	£1,485.00	£1,782.00
1100	550	CERAV1155E	750	£1,616.00	£1,939.20
1500	550	CERAV1555E	1000	£1,819.00	£2,182.80
1800	300	CERAV1830E	500	£1,600.00	£1,920.00
	550	CERAV1855E	1400	£1,932.00	£2,318.40

Please make sure you specify your finish at time of order; Senso, Varenna or Pavia

**Please Note: These radiators are very heavy and will require at least two people to lift and fit.**

Tested following the European standards and certified by qualified bodies.

Electric safety  
EN 60335-1, 2-30  
EN 62233

Electromagnetic compatibility  
EN 55014-1, -2  
EN 61000-3-2, 3-3



Class II Electric Radiators come with a fully programmable digital display on the side of the radiator that operates a thermostat offering standard settings such as frost protection, comfort mode, eco mode, auto mode, and boost mode.

# Torré shown on pages 36-37

High quality Italian design & manufacture.  
Ultra slimline extruded Aluminium profile with a curved edge  
UKCA approved & certified to BS EN442

White RAL 9016 as standard, 23 RAL colours plus 30 Special Finishes  
Please call **01342 302250** for a RAL or Special Finish chart  
Colour Coordination Service available on stock sizes see pages 6-7 for full details.

## Stock White RAL 9016: 48-72 Hours

Colours & Finishes: Up to 3 weeks (please allow an extra 10 working days for orders of over 10 radiators)

Pipe centres left to right	Pipe centres from wall	Depth from wall
width + valves	65mm	96mm



**SAVE £45** WHEN YOU BUY OUR **IDEAL TRV KIT** WITH ANY DESIGNER ORDER\* QUOTE **PROMOVI** AT TIME OF ORDER

Available in White or Chrome

## Stock options White RAL 9016 - Horizontal

Height (mm)	Width (mm)	Model	Watts $\Delta t 50^{\circ}c$	Btu's $\Delta t 50^{\circ}c$	White Ex VAT	White Inc VAT	Colours Ex VAT	Colours Inc VAT
DELIVERY TIMES					48-72 HOURS		UP TO 3 WEEKS	
500	956	TORR509508H	877	2992	<b>£702.00</b>	<b>£842.40</b>	£877.50	£1,053.00
	1196	TORR501110H	1097	3743	<b>£877.00</b>	<b>£1,052.40</b>	£1,096.25	£1,315.50
	1436	TORR501412H	1316	4490	<b>£1,056.00</b>	<b>£1,267.20</b>	£1,320.00	£1,584.00
600	956	TORR609508H	1007	3436	<b>£740.00</b>	<b>£888.00</b>	£925.00	£1,110.00
	1196	TORR601110H	1259	4296	<b>£928.00</b>	<b>£1,113.60</b>	£1,160.00	£1,392.00
	1436	TORR601412H	1510	5152	<b>£1,115.00</b>	<b>£1,338.00</b>	£1,393.75	£1,672.50

23 RAL colours are shown on page 197

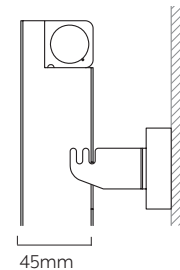
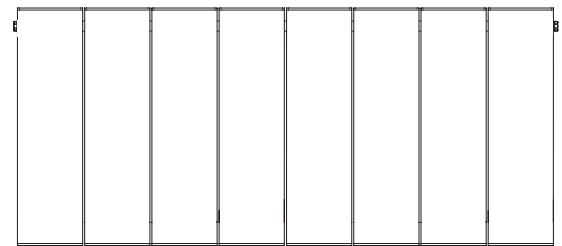

## Stock options White RAL 9016 - Vertical

Height (mm)	Width (mm)	Model	Watts $\Delta t 50^{\circ}c$	Btu's $\Delta t 50^{\circ}c$	White Ex VAT	White Inc VAT	Colours Ex VAT	Colours Inc VAT
DELIVERY TIMES					48-72 HOURS		UP TO 3 WEEKS	
1500	356	TORR153503V	784	2675	<b>£538.00</b>	<b>£645.60</b>	£672.50	£807.00
	476	TORR154704V	1045	3566	<b>£718.00</b>	<b>£861.60</b>	£897.50	£1,077.00
	596	TORR155905V	1306	4456	<b>£897.00</b>	<b>£1,076.40</b>	£1,121.25	£1,345.50
1800	356	TORR183503V	911	3108	<b>£568.00</b>	<b>£681.60</b>	£710.00	£852.00
	476	TORR184704V	1265	4316	<b>£755.00</b>	<b>£906.00</b>	£943.75	£1,132.50
	596	TORR185905V	1527	5210	<b>£942.00</b>	<b>£1,130.40</b>	£1,177.50	£1,413.00

23 RAL colours are shown on page 197

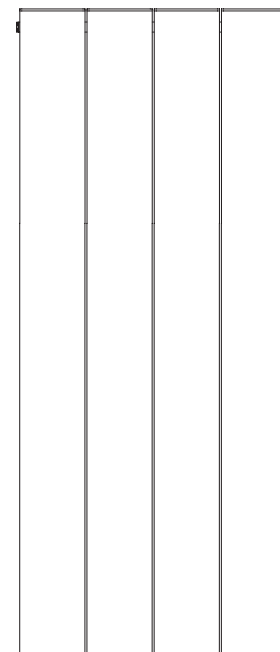

\*Saving based on the value of individual items when bought separately. Order any of our selected valves & matching pipe covers at the same time as your radiator; PROMOVIW (white), PROMOVIC (chrome).

# Niro shown on pages 38-39

High quality Italian design & manufacture.  
Ultra slimline extruded Aluminium profile  
CE/UKCA approved & certified to BS EN442.

White RAL 9016 as standard, 23 RAL colours plus 30 Special Finishes  
Please call **01342 302250** for a RAL or Special Finish chart  
Colour Coordination Service available on stock sizes see pages 6-7 for full details.

## Stock White RAL 9016: 48-72 Hours

Colours & Finishes: Up to 3 weeks (please allow an extra 10 working days for orders of over 10 radiators)



**SAVE £45** WHEN YOU BUY OUR **IDEAL TRV KIT** WITH ANY DESIGNER ORDER\*  
QUOTE **PROMOVI** AT TIME OF ORDER

Available in White or Chrome

Pipe centres left to right	Pipe centres from wall	Depth from wall
width + valves	59mm	77mm

## Stock options White RAL 9016 - Horizontal

Height (mm)	Width (mm)	Model	Watts Δt 50°C	Btu's Δt 50°C	White Ex VAT	White Inc VAT	Colours Ex VAT	Colours Inc VAT
DELIVERY TIMES					48-72 HOURS		UP TO 3 WEEKS	
631	799	NIROH637910	710	2423	<b>£770.00</b>	<b>£924.00</b>	£924.00	£1,108.80
	1039	NIROH631013	923	3149	<b>£1,001.00</b>	<b>£1,201.20</b>	£1,201.20	£1,441.44
	1199	NIROH631115	1065	3634	<b>£1,155.00</b>	<b>£1,386.00</b>	£1,386.00	£1,663.20

23 RAL colours are shown on page 197

## Stock options White RAL 9016 - Vertical

Height (mm)	Width (mm)	Model	Watts Δt 50°C	Btu's Δt 50°C	White Ex VAT	White Inc VAT	Colours Ex VAT	Colours Inc VAT
DELIVERY TIMES					48-72 HOURS		UP TO 3 WEEKS	
1831	399	NIROV183905	940	3207	<b>£648.00</b>	<b>£777.60</b>	£777.60	£933.12
	479	NIROV184706	1127	3845	<b>£778.00</b>	<b>£933.60</b>	£933.60	£1,120.32
	559	NIROV185507	1315	4487	<b>£906.00</b>	<b>£1,087.20</b>	£1,087.20	£1,304.64

23 RAL colours are shown on page 197

77mm  
59mm

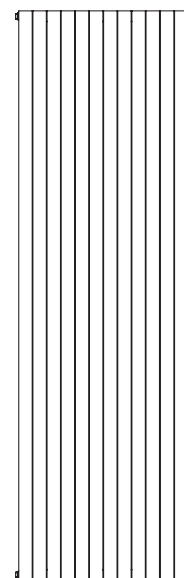

\*Saving based on the value of individual items when bought separately. Order any of our selected valves & matching pipe covers at the same time as your radiator; PROMOVIW (white), PROMOVIC (chrome).



# Iseo shown on pages 40-41

High quality Italian design & manufacture.  
85mm extruded Aluminium tubes with a curved edge  
CE/UKCA approved & certified to BS EN442.

White RAL 9016 as standard, 23 RAL colours plus 30 Special Finishes  
Please call **01342 302250** for a RAL or Special Finish chart  
Colour Coordination Service available on stock sizes see pages 6-7 for full details.

### Stock White RAL 9016: 48-72 Hours

Colours & Finishes: Up to 3 weeks  
(please allow an extra 10 working days for orders of over 10 radiators)



**SAVE £45** WHEN YOU BUY OUR **IDEAL TRV KIT** WITH ANY DESIGNER ORDER\*  
QUOTE **PROMOVI** AT TIME OF ORDER

Available in White or Chrome

Pipe centres left to right	Pipe centres from wall	Depth from wall
width + valves	36mm - 46mm	111mm - 121mm

### Stock options White RAL 9016 - Horizontal

Height (mm)	Width (mm)	Model	Watts Δt 50°C	Btu's Δt 50°C	White Ex VAT	White Inc VAT	Colours Ex VAT	Colours Inc VAT
DELIVERY TIMES					48-72 HOURS		UP TO 3 WEEKS	
500	845	ISEOH508410	928	3166	<b>£811.00</b>	<b>£973.20</b>	£973.20	£1,167.84
	1015	ISEOH501012	1114	3801	<b>£972.00</b>	<b>£1,166.40</b>	£1,166.40	£1,399.68
	1185	ISEOH501114	1299	4432	<b>£1,134.00</b>	<b>£1,360.80</b>	£1,360.80	£1,632.96
	1440	ISEOH501417	1578	5384	<b>£1,377.00</b>	<b>£1,652.40</b>	£1,652.40	£1,982.88

23 RAL colours are shown on page 197

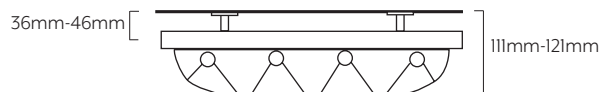

### Stock options White RAL 9016 - Vertical

Height (mm)	Width (mm)	Model	Watts Δt 50°C	Btu's Δt 50°C	White Ex VAT	White Inc VAT	Colours Ex VAT	Colours Inc VAT
DELIVERY TIMES					48-72 HOURS		UP TO 3 WEEKS	
1800	335	ISEOV183304	977	3334	<b>£583.00</b>	<b>£699.60</b>	£699.60	£839.52
	420	ISEOV184205	1222	4169	<b>£729.00</b>	<b>£874.80</b>	£874.80	£1,049.76
	505	ISEOV185006	1466	5002	<b>£876.00</b>	<b>£1,051.20</b>	£1,051.20	£1,261.44
	590	ISEOV185907	1710	5835	<b>£1,021.00</b>	<b>£1,225.20</b>	£1,225.20	£1,470.24

23 RAL colours are shown on page 197



\*Saving based on the value of individual items when bought separately. Order any of our selected valves & matching pipe covers at the same time as your radiator; PROMOVIV (white), PROMOVIC (chrome).



High quality Italian design & manufacture.  
60mm sections Aluminium radiator  
CE/UKCA approved & certified to BS EN442.

White RAL 9010 and Matt Silver

Please call **01342 302250** for colour chip sample.

### Stock White RAL 9010: 48-72 Hours

Made to order sizes: Up to 7 weeks White RAL 9010, Up to 9 weeks Matt Silver.



**SAVE £45** WHEN YOU BUY OUR **IDEAL TRV KIT** WITH ANY DESIGNER ORDER\*  
QUOTE **PROMOVI** AT TIME OF ORDER

Available in White or Chrome

Pipe centres left to right	Pipe centres from wall	Depth from wall
width + valves	50mm	80mm

### Stock options White RAL 9010 - Horizontal

Height (mm)	Width (mm)	Model	Watts Δt 50°C	Btu's Δt 50°C	White Ex VAT	White Inc VAT	Matt Silver Ex VAT	Matt Silver Inc VAT
DELIVERY TIMES					48-72 HOURS		UP TO 9 WEEKS	
634	820	SEBISH638210	995	3395	£695.00	£834.00	£903.50	£1,084.20
	980	SEBISH639812	1194	4074	£824.00	£988.80	£1,071.20	£1,285.44
	1140	SEBISH631114	1393	4753	£938.00	£1,125.60	£1,219.40	£1,463.28

### Stock options White RAL 9010 - Vertical

Height (mm)	Width (mm)	Model	Watts Δt 50°C	Btu's Δt 50°C	White Ex VAT	White Inc VAT	Matt Silver Ex VAT	Matt Silver Inc VAT
DELIVERY TIMES					48-72 HOURS		UP TO 9 WEEKS	
1834	340	SEBISVI183404	929	3170	£671.00	£805.20	£872.30	£1,046.76
	500	SEBISVI185006	1394	4756	£909.00	£1,090.80	£1,181.70	£1,418.04
	660	SEBISVI186608	1858	6339	£1,149.00	£1,378.80	£1,493.70	£1,792.44

Made to order options - Horizontal

Height (mm)	Width (mm)	Model	Watts Δt 50°C	Btu's Δt 50°C	White Ex VAT	White Inc VAT	Matt Silver Ex VAT	Matt Silver Inc VAT
DELIVERY TIMES					UP TO 7 WEEKS		UP TO 9 WEEKS	
384	500	SEBISH385006	392	1338	£395.00	£474.00	£513.50	£616.20
	660	SEBISH386608	523	1784	£493.00	£591.60	£640.90	£769.08
	820	SEBISH388210	654	2231	£591.00	£709.20	£768.30	£921.96
	980	SEBISH389812	785	2678	£695.00	£834.00	£903.50	£1,084.20
	1140	SEBISH381114	916	3125	£794.00	£952.80	£1,032.20	£1,238.64
534	500	SEBISH535006	518	1767	£434.00	£520.80	£564.20	£677.04
	660	SEBISH536608	690	2354	£546.00	£655.20	£709.80	£851.76
	820	SEBISH538210	863	2945	£656.00	£787.20	£852.80	£1,023.36
	980	SEBISH539812	1036	3535	£774.00	£928.80	£1,006.20	£1,207.44
634	500	SEBISH635006	597	2037	£464.00	£556.80	£603.20	£723.84
	660	SEBISH636608	796	2716	£582.00	£698.40	£756.60	£907.92
	820	SEBISH638210	974	3305	£699.00	£838.80	£897.00	£1,078.20
734	500	SEBISH735006	674	2300	£487.00	£584.40	£633.10	£759.72
	660	SEBISH736608	898	3064	£615.00	£738.00	£799.50	£959.40
	820	SEBISH738210	1123	3832	£745.00	£894.00	£968.50	£1,162.20
	980	SEBISH739812	1348	4599	£870.00	£1,044.00	£1,131.00	£1,357.20
834	500	SEBISH835006	748	2552	£513.00	£615.60	£666.90	£800.28
	660	SEBISH836608	998	3405	£651.00	£781.20	£846.30	£1,015.56
	820	SEBISH838210	1247	4255	£789.00	£946.80	£1,025.70	£1,230.84
	980	SEBISH839812	1496	5104	£926.00	£1,111.20	£1,203.80	£1,444.56
	1140	SEBISH831114	1746	5957	£1,056.00	£1,267.20	£1,372.80	£1,647.36
934	500	SEBISH935006	821	2801	£635.00	£762.00	£825.50	£990.60
	660	SEBISH936608	1094	3733	£789.00	£946.80	£1,025.70	£1,230.84
	820	SEBISH938210	1368	4668	£948.00	£1,137.60	£1,232.40	£1,478.88
	980	SEBISH939812	1642	5603	£1,096.00	£1,315.20	£1,424.80	£1,709.76
1034	500	SEBISH105006	890	3037	£686.00	£823.20	£891.80	£1,070.16
	660	SEBISH106608	1187	4050	£858.00	£1,029.60	£1,115.40	£1,338.48
	820	SEBISH108210	1484	5063	£1,027.00	£1,232.40	£1,335.10	£1,602.12
	980	SEBISH109812	1781	6077	£1,185.00	£1,422.00	£1,540.50	£1,848.60
	1140	SEBISH101114	2078	7090	£1,352.00	£1,622.40	£1,757.60	£2,109.12

Made to order options - Vertical

Height (mm)	Width (mm)	Model	Watts Δt 50°C	Btu's Δt 50°C	White Ex VAT	White Inc VAT	Matt Silver Ex VAT	Matt Silver Inc VAT
DELIVERY TIMES					UP TO 7 WEEKS		UP TO 9 WEEKS	
1234	340	SEBISVI123404	684	2334	£557.00	£668.40	£724.10	£868.92
	500	SEBISVI125006	1025	3497	£740.00	£888.00	£962.00	£1,154.40
	660	SEBISVI126608	1367	4664	£929.00	£1,114.80	£1,207.70	£1,449.24
	820	SEBISVI128210	1709	5831	£1,115.00	£1,338.00	£1,449.50	£1,739.40
1434	340	SEBISVI143404	769	2624	£596.00	£715.20	£774.80	£929.76
	500	SEBISVI145006	1154	3937	£804.00	£964.80	£1,045.20	£1,254.24
	660	SEBISVI146608	1538	5248	£1,002.00	£1,202.40	£1,302.60	£1,563.12
1634	340	SEBISVI163404	851	2904	£637.00	£764.40	£828.10	£993.72
	500	SEBISVI165006	1277	4357	£858.00	£1,029.60	£1,115.40	£1,338.48
	660	SEBISVI166608	1702	5807	£1,080.00	£1,296.00	£1,404.00	£1,684.80
1834	340	SEBISVI183404	929	3170	£671.00	£805.20	£872.30	£1,046.76
	500	SEBISVI185006	1394	4756	£909.00	£1,090.80	£1,181.70	£1,418.04
	660	SEBISVI186608	1858	6339	£1,149.00	£1,378.80	£1,493.70	£1,792.44
2034	340	SEBISV203404	1004	3426	£710.00	£852.00	£923.00	£1,107.60
	500	SEBISV205006	1507	5142	£972.00	£1,166.40	£1,263.60	£1,516.32
	660	SEBISV206608	2009	6855	£1,224.00	£1,468.80	£1,591.20	£1,909.44
	820	SEBISV208210	2511	8568	£1,475.00	£1,770.00	£1,917.50	£2,301.00

80mm  
50mm

Top view in Matt Silver

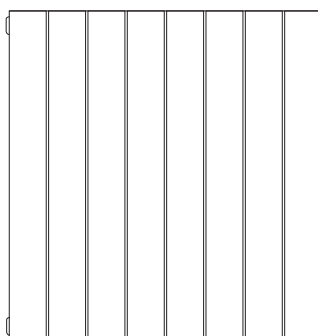

\*Saving based on the value of individual items when bought separately. Order any of our selected valves & matching pipe covers at the same time as your radiator; PROMOVIW (white), PROMOVIC (chrome).

# Odolo shown on pages 44-45

High quality Italian design & manufacture.

Aluminium, 2 column sections

Odolo radiators are protected against corrosion with Aleternum®, an exclusive resin-based internal coating to protect the radiator water chamber. CE/UKCA approved & certified to BS EN442.

White RAL 9010

## White RAL 9010: 48-72 Hours

Pipe centres left to right	Pipe centres from wall	Depth from wall
width + valves	80mm	125mm



**SAVE £45** WHEN YOU BUY OUR **IDEAL TRV KIT** WITH ANY DESIGNER ORDER\*  
QUOTE **PROMOVI** AT TIME OF ORDER  
Available in White or Chrome

## Stock options White RAL 9010 - Horizontal

Height (mm)	Width (mm)	Model	Watts Δt 50°C	Btu's Δt 50°C	White Ex VAT	White Inc VAT
DELIVERY TIMES					48-72 HOURS	
649	474	ODOLH644709	574	1958	£737.00	£884.40
	624	ODOLH646212	766	2614	£964.00	£1,156.80
	824	ODOLH648216	1021	3484	£1,266.00	£1,519.20
	1024	ODOLH641020	1276	4354	£1,569.00	£1,882.80
	1224	ODOLH641224	1531	5224	£1,871.00	£2,245.20

125mm  
80mm

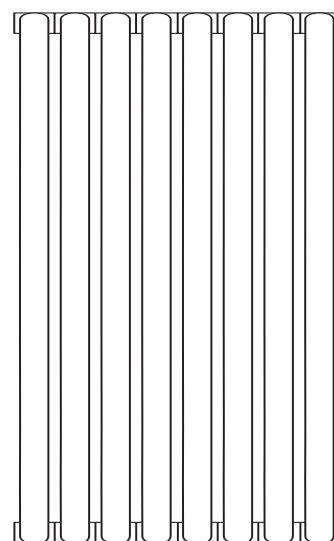
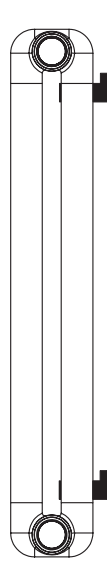

## Stock options White RAL 9010 - Vertical

Height (mm)	Width (mm)	Model	Watts Δt 50°C	Btu's Δt 50°C	White Ex VAT	White Inc VAT
DELIVERY TIMES					48-72 HOURS	
1849	324	ODOLV183206	1016	3467	£651.00	£781.20
	424	ODOLV184208	1355	4623	£850.00	£1,020.00
	474	ODOLV184709	1525	5203	£949.00	£1,138.80
	524	ODOLV185210	1694	5780	£1,049.00	£1,258.80
	624	ODOLV186212	2033	6937	£1,247.00	£1,496.40

®Aleternum

\*Saving based on the value of individual items when bought separately. Order any of our selected valves & matching pipe covers at the same time as your radiator; PROMOVIW (white), PROMOVIC (chrome).

# Canto shown on page 46



High quality Italian design & manufacture.  
95mm sections Aluminium radiator  
CE/UKCA approved & certified to BS EN442.

White RAL 9010 as standard, 23 RAL colours plus 30 Special Finishes  
Please call **01342 302250** for a RAL or Special Finish chart  
Colour Coordination Service available on stock sizes see pages 6-7 for full details.

## Stock White RAL 9010: 48-72 Hours

Colours & Finishes: Up to 3 weeks (please allow an extra 10 working days for orders of over 10 radiators)



**SAVE £45** WHEN YOU BUY OUR **IDEAL TRV KIT** WITH ANY DESIGNER ORDER\*  
QUOTE **PROMOVI** AT TIME OF ORDER

Available in White or Chrome

Pipe centres left to right	Pipe centres from wall	Depth from wall
width + valves	70mm	120mm

## Stock options White RAL 9010 - Horizontal

Height (mm)	Width (mm)	Model	Watts Δt 50°C	Btu's Δt 50°C	White Ex VAT	White Inc VAT	Colours Ex VAT	Colours Inc VAT
DELIVERY TIMES					48-72 HOURS		UP TO 3 WEEKS	
568	420	CANT564208H	488	1665	£250.00	£300.00	£312.50	£375.00
	620	CANT566212H	732	2498	£364.00	£436.80	£455.00	£546.00
	820	CANT568216H	976	3330	£482.00	£578.40	£602.50	£723.00
	1020	CANT561020H	1220	4163	£595.00	£714.00	£743.75	£892.50
668	420	CANT664208H	552	1883	£255.00	£306.00	£318.75	£382.50
	620	CANT666212H	828	2825	£373.00	£447.60	£466.25	£559.50
	820	CANT668216H	1104	3767	£492.00	£590.40	£615.00	£738.00
	1020	CANT661020H	1380	4709	£611.00	£733.20	£763.75	£916.50

23 RAL colours are shown on page 197

Please note widths include measurements for bushes

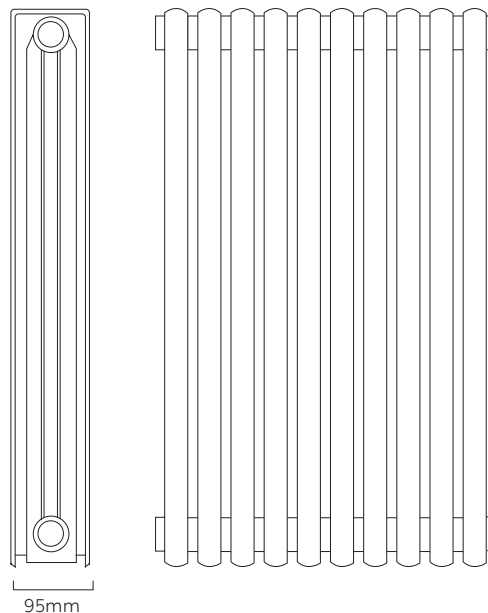
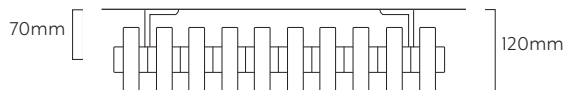

## Stock options White RAL 9010 - Vertical

Height (mm)	Width (mm)	Model	Watts Δt 50°C	Btu's Δt 50°C	White Ex VAT	White Inc VAT	Colours Ex VAT	Colours Inc VAT
DELIVERY TIMES					48-72 HOURS		UP TO 3 WEEKS	
1470	270	CANT142705V	715	2440	£445.00	£534.00	£556.25	£667.50
	420	CANT144208V	1144	3903	£699.00	£838.80	£873.75	£1,048.50
	520	CANT145210V	1430	4879	£866.00	£1,039.20	£1,082.50	£1,299.00
1870	270	CANT182705V	890	3037	£525.00	£630.00	£656.25	£787.50
	420	CANT184208V	1424	4859	£827.00	£992.40	£1,033.75	£1,240.50
	520	CANT185210V	1780	6073	£1,028.00	£1,233.60	£1,285.00	£1,542.00

23 RAL colours are shown on page 197

Please note widths include measurements for bushes

\*Saving based on the value of individual items when bought separately. Order any of our selected valves & matching pipe covers at the same time as your radiator; PROMOVIW (white), PROMOVIC (chrome).

# Ellipsis Stainless Steel shown on page 47

Stainless Steel; 25mm x 50mm oval tubes  
CE/UKCA approved & certified to BS EN442.

Polished or Brushed Stainless Steel

**All sizes delivered in 48-72 Hours**



**SAVE £45** WHEN YOU BUY OUR **IDEAL TRV KIT** WITH ANY DESIGNER ORDER\*  
QUOTE **PROMOVI** AT TIME OF ORDER

Available in White or Chrome

Pipe centres left to right	Pipe centres from wall	Depth from wall
width + valves	50mm	90mm

## Single Vertical - Polished Stainless Steel

Height (mm)	Width (mm)	Model	Watts $\Delta t 50^{\circ}c$	Btu's $\Delta t 50^{\circ}c$	Polished Stainless Steel Ex VAT	Polished Stainless Steel Inc VAT
DELIVERY TIMES					<b>48-72 HOURS</b>	
1800	295	ELLISV182905PO	402	1372	<b>£469.00</b>	<b>£562.80</b>
	413	ELLISV184107PO	564	1924	<b>£625.00</b>	<b>£750.00</b>

## Double Vertical - Polished Stainless Steel

Height (mm)	Width (mm)	Model	Watts $\Delta t 50^{\circ}c$	Btu's $\Delta t 50^{\circ}c$	Polished Stainless Steel Ex VAT	Polished Stainless Steel Inc VAT
DELIVERY TIMES					<b>48-72 HOURS</b>	
1800	295	ELLIDV182910PO	644	2197	<b>£825.00</b>	<b>£990.00</b>
	413	ELLIDV184114PO	902	3078	<b>£1,078.00</b>	<b>£1,293.60</b>

## Single Vertical - Brushed Stainless Steel

Height (mm)	Width (mm)	Model	Watts $\Delta t 50^{\circ}c$	Btu's $\Delta t 50^{\circ}c$	Brushed Stainless Steel Ex VAT	Brushed Stainless Steel Inc VAT
DELIVERY TIMES					<b>48-72 HOURS</b>	
1800	295	ELLISV182905BR	402	1372	<b>£469.00</b>	<b>£562.80</b>
	413	ELLISV184107BR	564	1924	<b>£625.00</b>	<b>£750.00</b>

## Double Vertical - Brushed Stainless Steel

Height (mm)	Width (mm)	Model	Watts $\Delta t 50^{\circ}c$	Btu's $\Delta t 50^{\circ}c$	Brushed Stainless Steel Ex VAT	Brushed Stainless Steel Inc VAT
DELIVERY TIMES					<b>48-72 HOURS</b>	
1800	295	ELLIDV182910BR	644	2197	<b>£825.00</b>	<b>£990.00</b>
	413	ELLIDV184114BR	902	3078	<b>£1,078.00</b>	<b>£1,293.60</b>

Single

Double



90mm  
50mm

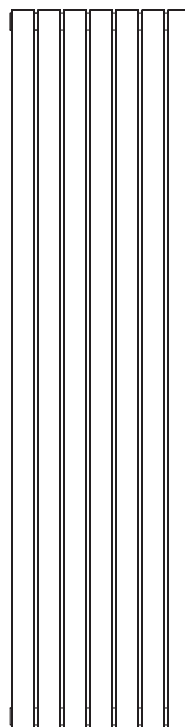

90mm  
50mm



\*Saving based on the value of individual items when bought separately. Order any of our selected valves & matching pipe covers at the same time as your radiator; PROMOVIW (white), PROMOVIC (chrome).

# Ellipsis Single Horizontal shown on pages 48-49



High quality Italian design & manufacture.  
Steel; 25mm x 50mm oval tubes  
CE/UKCA approved & certified to BS EN442.



White RAL 9016 as standard, 188 RAL colours plus 30 Special Finishes  
Please call **01342 302250** for a RAL or Special Finish chart  
Colour Coordination Service available on stock sizes see pages 6-7 for full details.

**Stock White RAL 9016 & Textured Anthracite: 48-72 Hours**  
Made to Order sizes & colours: Up to 7 weeks

Pipe centres left to right	Pipe centres from wall	Depth from wall
width - 50mm	55mm	95mm



**SAVE £45** WHEN YOU BUY OUR IDEAL TRV KIT WITH ANY DESIGNER ORDER\*  
QUOTE **PROMOVI** AT TIME OF ORDER

Available in White or Chrome



## Stock options White RAL 9016 Single Horizontal

Height (mm)	Width (mm)	Model	Watts Δt 50°C	Btu's Δt 50°C	White Ex VAT	White Inc VAT	Colours Ex VAT	Colours Inc VAT
DELIVERY TIMES					48-72 HOURS		UP TO 7 WEEKS	
420	1020	ELLISH421007	481	1641	£380.00	£456.00	£475.00	£570.00
	1220	ELLISH421207	575	1962	£387.00	£464.40	£483.75	£580.50
	1520	ELLISH421507	717	2446	£412.00	£494.40	£515.00	£618.00
480	1020	ELLISH481008	549	1873	£437.00	£524.40	£546.25	£655.50
	1220	ELLISH481208	657	2242	£449.00	£538.80	£561.25	£673.50
	1520	ELLISH481508	818	2791	£451.00	£541.20	£563.75	£676.50
600	650	ELLISH606510	437	1491	£483.00	£579.60	£603.75	£724.50
	1020	ELLISH601010	686	2341	£508.00	£609.60	£635.00	£762.00
	1220	ELLISH601210	821	2801	£524.00	£628.80	£655.00	£786.00
	1520	ELLISH601510	1022	3487	£538.00	£645.60	£672.50	£807.00

## Stock options Textured Anthracite Single Horizontal New

Height (mm)	Width (mm)	Model	Watts Δt 50°C	Btu's Δt 50°C	Textured Anthracite Ex VAT	Textured Anthracite Inc VAT
DELIVERY TIMES					48-72 HOURS	
600	1020	ELLISH601010TA	686	2341	£635.00	£762.00
	1220	ELLISH601210TA	821	2801	£655.00	£786.00

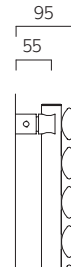

Made to order options - Single Horizontal

Height (mm)	Width (mm)	Model	Watts Δt 50°C	Btu's Δt 50°C	White Ex VAT	White Inc VAT	Colours Ex VAT	Colours Inc VAT
DELIVERY TIMES					UP TO 7 WEEKS		UP TO 7 WEEKS	
300	520	ELLISH305205	175	597	£289.00	£346.80	£361.25	£433.50
	650	ELLISH306505	219	747	£305.00	£366.00	£381.25	£457.50
	700	ELLISH307005	236	805	£306.00	£367.20	£382.50	£459.00
	920	ELLISH309205	310	1058	£307.00	£368.40	£383.75	£460.50
	1020	ELLISH301005	344	1174	£311.00	£373.20	£388.75	£466.50
	1220	ELLISH301205	411	1402	£320.00	£384.00	£400.00	£480.00
	1520	ELLISH301505	512	1747	£324.00	£388.80	£405.00	£486.00
	1820	ELLISH301805	613	2092	£341.00	£409.20	£426.25	£511.50
	2020	ELLISH302005	681	2324	£349.00	£418.80	£436.25	£523.50
480	520	ELLISH485208	280	955	£407.00	£488.40	£508.75	£610.50
	650	ELLISH486508	350	1194	£426.00	£511.20	£532.50	£639.00
	700	ELLISH487008	377	1286	£427.00	£512.40	£533.75	£640.50
	920	ELLISH489208	495	1689	£429.00	£514.80	£536.25	£643.50
	1820	ELLISH481808	980	3344	£475.00	£570.00	£593.75	£712.50
2020	ELLISH482008	1087	3709	£485.00	£582.00	£606.25	£727.50	
540	520	ELLISH545209	315	1075	£433.00	£519.60	£541.25	£649.50
	650	ELLISH546509	394	1344	£451.00	£541.20	£563.75	£676.50
	700	ELLISH547009	425	1450	£459.00	£550.80	£573.75	£688.50
	920	ELLISH549209	558	1904	£463.00	£555.60	£578.75	£694.50
	1020	ELLISH541009	619	2112	£470.00	£564.00	£587.50	£705.00
	1220	ELLISH541209	740	2525	£481.00	£577.20	£601.25	£721.50
	1520	ELLISH541509	922	3146	£498.00	£597.60	£622.50	£747.00
	1820	ELLISH541809	1104	3767	£516.00	£619.20	£645.00	£774.00
	2020	ELLISH542009	1225	4180	£572.00	£686.40	£715.00	£858.00

Height (mm)	Width (mm)	Model	Watts Δt 50°C	Btu's Δt 50°C	White Ex VAT	White Inc VAT	Colours Ex VAT	Colours Inc VAT
DELIVERY TIMES					UP TO 7 WEEKS		UP TO 7 WEEKS	
600	700	ELLISH607010	471	1607	£491.00	£589.20	£613.75	£736.50
	920	ELLISH609210	619	2112	£498.00	£597.60	£622.50	£747.00
	1820	ELLISH601810	1224	4176	£564.00	£676.80	£705.00	£846.00
	2020	ELLISH602010	1359	4637	£583.00	£699.60	£728.75	£874.50
	650	ELLISH726512	526	1795	£570.00	£684.00	£712.50	£855.00
720	700	ELLISH727012	566	1931	£586.00	£703.20	£732.50	£879.00
	920	ELLISH729212	744	2539	£602.00	£722.40	£752.50	£903.00
	1020	ELLISH721012	825	2815	£619.00	£742.80	£773.75	£928.50
	1220	ELLISH721212	987	3368	£634.00	£760.80	£792.50	£951.00
	1520	ELLISH721512	1229	4193	£659.00	£790.80	£823.75	£988.50
	1820	ELLISH721812	1472	5022	£683.00	£819.60	£853.75	£1,024.50
2020	ELLISH722012	1634	5575	£759.00	£910.80	£948.75	£1,138.50	
900	650	ELLISH906515	657	2242	£727.00	£872.40	£908.75	£1,090.50
	700	ELLISH907015	708	2416	£751.00	£901.20	£938.75	£1,126.50
	920	ELLISH909215	930	3173	£772.00	£926.40	£965.00	£1,158.00
	1020	ELLISH901015	1031	3518	£790.00	£948.00	£987.50	£1,185.00
	1220	ELLISH901215	1233	4207	£813.00	£975.60	£1,016.25	£1,219.50
	1520	ELLISH901515	1537	5244	£843.00	£1,011.60	£1,053.75	£1,264.50
	1820	ELLISH901815	1840	6278	£872.00	£1,046.40	£1,090.00	£1,308.00
	2020	ELLISH902015	2042	6967	£967.00	£1,160.40	£1,208.75	£1,450.50

\*Saving based on the value of individual items when bought separately.  
Order any of our selected valves & matching pipe covers at the same time as your radiator;  
PROMOVIW (white), PROMOVIC (chrome).

# Ellipsis Double Horizontal shown on pages 48-49



High quality Italian design & manufacture.  
 Steel; 25mm x 50mm oval tubes  
 CE/UKCA approved & certified to BS EN442.



White RAL 9016 as standard, 188 RAL colours plus 30 Special Finishes  
 Please call **01342 302250** for a RAL or Special Finish chart  
 Colour Coordination Service available on stock sizes see pages 6-7 for full details.

**Stock White RAL 9016 & Textured Anthracite: 48-72 Hours**  
 Made to Order sizes & colours: Up to 7 weeks

Pipe centres left to right	Pipe centres from wall	Depth from wall
width - 50mm	80mm-90mm	120mm-130mm



**SAVE £45** WHEN YOU BUY OUR **IDEAL TRV KIT** WITH ANY DESIGNER ORDER\* QUOTE **PROMOVI** AT TIME OF ORDER

Available in White or Chrome

## Stock options White RAL 9016 - Double Horizontal

Height (mm)	Width (mm)	Model	Watts $\Delta t$ 50°C	Btu's $\Delta t$ 50°C	DELIVERY TIMES			
					White Ex VAT	White Inc VAT	Colours Ex VAT	Colours Inc VAT
					<b>48-72 HOURS</b>		UP TO 7 WEEKS	
420	1020	ELLIDH421007	748	2552	£562.00	£674.40	£702.50	£843.00
	1220	ELLIDH421207	895	3054	£578.00	£693.60	£722.50	£867.00
	1520	ELLIDH421507	1115	3804	£637.00	£764.40	£796.25	£955.50
480	1020	ELLIDH481008	855	2917	£649.00	£778.80	£811.25	£973.50
	1220	ELLIDH481208	1023	3490	£666.00	£799.20	£832.50	£999.00
	1520	ELLIDH481508	1274	4347	£687.00	£824.40	£858.75	£1,030.50
600	650	ELLIDH606510	681	2324	£724.00	£868.80	£905.00	£1,086.00
	1020	ELLIDH601010	1069	3647	£776.00	£931.20	£970.00	£1,164.00
	1220	ELLIDH601210	1279	4364	£806.00	£967.20	£1,007.50	£1,209.00
	1520	ELLIDH601510	1593	5435	£824.00	£988.80	£1,030.00	£1,236.00

## Stock options Textured Anthracite - Double Horizontal <sup>New</sup>

Height (mm)	Width (mm)	Model	Watts $\Delta t$ 50°C	Btu's $\Delta t$ 50°C	DELIVERY TIMES		
					Textured Anthracite Ex VAT	Textured Anthracite Inc VAT	Colours Ex VAT
					<b>48-72 HOURS</b>		UP TO 7 WEEKS
600	1020	ELLIDH601010TA	1069	3647	£970.00	£1,164.00	
	1220	ELLIDH601210TA	1279	4364	£1,007.50	£1,209.00	

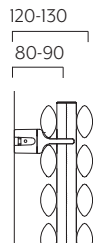

## Made to order options - Double Horizontal

Height (mm)	Width (mm)	Model	Watts $\Delta t$ 50°C	Btu's $\Delta t$ 50°C	DELIVERY TIMES			
					White Ex VAT	White Inc VAT	Colours Ex VAT	Colours Inc VAT
					UP TO 7 WEEKS		UP TO 7 WEEKS	
300	520	ELLIDH305205	273	931	£371.00	£445.20	£463.75	£556.50
	650	ELLIDH306505	341	1163	£471.00	£565.20	£588.75	£706.50
	700	ELLIDH307005	367	1252	£479.00	£574.80	£598.75	£718.50
	920	ELLIDH309205	483	1648	£483.00	£579.60	£603.75	£724.50
	1020	ELLIDH301005	535	1825	£487.00	£584.40	£608.75	£730.50
	1220	ELLIDH301205	640	2184	£502.00	£602.40	£627.50	£753.00
	1520	ELLIDH301505	797	2719	£512.00	£614.40	£640.00	£768.00
	1820	ELLIDH301805	955	3258	£547.00	£656.40	£683.75	£820.50
	2020	ELLIDH302005	1060	3617	£562.00	£674.40	£702.50	£843.00
	480	520	ELLIDH485208	436	1488	£536.00	£643.20	£670.00
650		ELLIDH486508	545	1860	£626.00	£751.20	£782.50	£939.00
700		ELLIDH487008	587	2003	£633.00	£759.60	£791.25	£949.50
920		ELLIDH489208	771	2631	£641.00	£769.20	£801.25	£961.50
1820		ELLIDH481808	1526	5207	£720.00	£864.00	£900.00	£1,080.00
2020	ELLIDH482008	1693	5777	£741.00	£889.20	£926.25	£1,111.50	
	520	ELLIDH545209	491	1675	£637.00	£764.40	£796.25	£955.50
540	650	ELLIDH546509	614	2095	£680.00	£816.00	£850.00	£1,020.00
	700	ELLIDH547009	661	2255	£688.00	£825.60	£860.00	£1,032.00
	920	ELLIDH549209	869	2965	£699.00	£838.80	£873.75	£1,048.50
	1020	ELLIDH541009	963	3286	£706.00	£847.20	£882.50	£1,059.00
	1220	ELLIDH541209	1152	3931	£728.00	£873.60	£910.00	£1,092.00
	1520	ELLIDH541509	1435	4896	£741.00	£889.20	£926.25	£1,111.50
	1820	ELLIDH541809	1718	5862	£799.00	£958.80	£998.75	£1,198.50
	2020	ELLIDH542009	1907	6507	£848.00	£1,017.60	£1,060.00	£1,272.00

Height (mm)	Width (mm)	Model	Watts $\Delta t$ 50°C	Btu's $\Delta t$ 50°C	DELIVERY TIMES			
					White Ex VAT	White Inc VAT	Colours Ex VAT	Colours Inc VAT
					UP TO 7 WEEKS		UP TO 7 WEEKS	
600	700	ELLIDH607010	734	2504	£735.00	£882.00	£918.75	£1,102.50
	920	ELLIDH609210	964	3289	£752.00	£902.40	£940.00	£1,128.00
	1820	ELLIDH601810	1907	6507	£889.00	£1,066.80	£1,111.25	£1,333.50
	2020	ELLIDH602010	2117	7223	£925.00	£1,110.00	£1,156.25	£1,387.50
	650	ELLIDH726512	818	2791	£796.00	£955.20	£995.00	£1,194.00
720	700	ELLIDH727012	881	3006	£829.00	£994.80	£1,036.25	£1,243.50
	920	ELLIDH729212	1158	3951	£864.00	£1,036.80	£1,080.00	£1,296.00
	1020	ELLIDH721012	1284	4381	£898.00	£1,077.60	£1,122.50	£1,347.00
	1220	ELLIDH721212	1536	5241	£959.00	£1,150.80	£1,198.75	£1,438.50
	1520	ELLIDH721512	1913	6527	£989.00	£1,186.80	£1,236.25	£1,483.50
900	1820	ELLIDH721812	2291	7817	£1,061.00	£1,273.20	£1,326.25	£1,591.50
	2020	ELLIDH722012	2543	8677	£1,151.00	£1,381.20	£1,438.75	£1,726.50
	650	ELLIDH906515	1023	3490	£941.00	£1,129.20	£1,176.25	£1,411.50
	700	ELLIDH907015	1101	3757	£984.00	£1,180.80	£1,230.00	£1,476.00
	920	ELLIDH909215	1448	4941	£1,018.00	£1,221.60	£1,272.50	£1,527.00
900	1020	ELLIDH901015	1605	5476	£1,092.00	£1,310.40	£1,365.00	£1,638.00
	1220	ELLIDH901215	1920	6551	£1,196.00	£1,435.20	£1,495.00	£1,794.00
	1520	ELLIDH901515	2392	8162	£1,236.00	£1,483.20	£1,545.00	£1,854.00
	1820	ELLIDH901815	2864	9772	£1,325.00	£1,590.00	£1,656.25	£1,987.50
	2020	ELLIDH902015	3179	10847	£1,437.00	£1,724.40	£1,796.25	£2,155.50

\*Saving based on the value of individual items when bought separately.  
 Order any of our selected valves & matching pipe covers at the same time as your radiator;  
 PROMOVIW (white), PROMOVIC (chrome).

# Ellipsis Single Vertical shown on pages 48-49



High quality Italian design & manufacture.  
Steel; 25mm x 50mm oval tubes  
CE/UKCA approved & certified to BS EN442.



White RAL 9016 as standard, 188 RAL colours plus 30 Special Finishes  
Please call **01342 302250** for a RAL or Special Finish chart  
Colour Coordination Service available on stock sizes see pages 6-7 for full details.



## Stock White RAL 9016 & Textured Anthracite: 48-72 Hours

Made to Order sizes & colours: Up to 7 weeks.



**SAVE £45** WHEN YOU BUY OUR IDEAL TRV KIT WITH ANY DESIGNER ORDER\*  
QUOTE **PROMOVI** AT TIME OF ORDER

Available in White or Chrome

Pipe centres left to right	Pipe centres from wall	Depth from wall
width + valves	55mm	95mm

## Stock options White RAL 9016 - Single Vertical

Height (mm)	Width (mm)	Model	Watts Δt 50°C	Btu's Δt 50°C	White Ex VAT	White Inc VAT	Colours Ex VAT	Colours Inc VAT
DELIVERY TIMES					48-72 HOURS		UP TO 7 WEEKS	
1820	300	ELLISV183005	628	2143	£341.00	£409.20	£426.25	£511.50
	420	ELLISV184207	879	2999	£437.00	£524.40	£546.25	£655.50
	480	ELLISV184808	1004	3426	£475.00	£570.00	£593.75	£712.50
	600	ELLISV186010	1255	4282	£564.00	£676.80	£705.00	£846.00

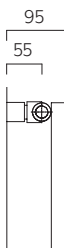

## Stock options Textured Anthracite - Single Vertical New

Height (mm)	Width (mm)	Model	Watts Δt 50°C	Btu's Δt 50°C	Textured Anthracite Ex VAT	Textured Anthracite Inc VAT
DELIVERY TIMES					48-72 HOURS	
1820	480	ELLISV184808TA	1004	3426	£593.75	£712.50
	600	ELLISV186010TA	1255	4282	£705.00	£846.00

Made to order options - Single Vertical

Height (mm)	Width (mm)	Model	Watts Δt 50°C	Btu's Δt 50°C	White Ex VAT	White Inc VAT	Colours Ex VAT	Colours Inc VAT
DELIVERY TIMES					UP TO 7 WEEKS		UP TO 7 WEEKS	
520	300	ELLISV523005	187	638	£289.00	£346.80	£361.25	£433.50
	480	ELLISV524808	298	1017	£407.00	£488.40	£508.75	£610.50
	540	ELLISV525409	336	1146	£433.00	£519.60	£541.25	£649.50
	600	ELLISV526010	373	1273	£459.00	£550.80	£573.75	£688.50
	720	ELLISV527212	448	1529	£548.00	£657.60	£685.00	£822.00
650	300	ELLISV653005	233	795	£305.00	£366.00	£381.25	£457.50
	480	ELLISV654808	372	1269	£426.00	£511.20	£532.50	£639.00
	540	ELLISV655409	419	1430	£451.00	£541.20	£563.75	£676.50
	600	ELLISV656010	465	1587	£483.00	£579.60	£603.75	£724.50
	720	ELLISV657212	558	1904	£570.00	£684.00	£712.50	£855.00
700	300	ELLISV703005	252	860	£306.00	£367.20	£382.50	£459.00
	480	ELLISV704808	402	1372	£427.00	£512.40	£533.75	£640.50
	540	ELLISV705409	453	1546	£459.00	£550.80	£573.75	£688.50
	600	ELLISV706010	503	1716	£491.00	£589.20	£613.75	£736.50
	720	ELLISV707212	604	2061	£586.00	£703.20	£732.50	£879.00
920	240	ELLISV922404	261	891	£249.00	£298.80	£311.25	£373.50
	300	ELLISV923005	327	1116	£307.00	£368.40	£383.75	£460.50
	480	ELLISV924808	522	1781	£429.00	£514.80	£536.25	£643.50
	540	ELLISV925409	588	2006	£463.00	£555.60	£578.75	£694.50
	600	ELLISV926010	653	2228	£498.00	£597.60	£622.50	£747.00
1020	240	ELLISV102404	288	983	£256.00	£307.20	£320.00	£384.00
	300	ELLISV103005	360	1228	£311.00	£373.20	£388.75	£466.50
	480	ELLISV104808	576	1965	£437.00	£524.40	£546.25	£655.50
	540	ELLISV105409	648	2211	£470.00	£564.00	£587.50	£705.00
	600	ELLISV106010	720	2457	£508.00	£609.60	£635.00	£762.00

Height (mm)	Width (mm)	Model	Watts Δt 50°C	Btu's Δt 50°C	White Ex VAT	White Inc VAT	Colours Ex VAT	Colours Inc VAT
DELIVERY TIMES					UP TO 7 WEEKS		UP TO 7 WEEKS	
1220	240	ELLISV122404	341	1163	£273.00	£327.60	£341.25	£409.50
	300	ELLISV123005	427	1457	£320.00	£384.00	£400.00	£480.00
	480	ELLISV124808	682	2327	£449.00	£538.80	£561.25	£673.50
	540	ELLISV125409	768	2620	£481.00	£577.20	£601.25	£721.50
	600	ELLISV126010	853	2910	£524.00	£628.80	£655.00	£786.00
	720	ELLISV127212	1024	3494	£634.00	£760.80	£792.50	£951.00
	840	ELLISV128414	1194	4074	£753.00	£903.60	£941.25	£1,129.50
	1520	240	ELLISV152404	421	1436	£293.00	£351.60	£366.25
300		ELLISV153005	527	1798	£324.00	£388.80	£405.00	£486.00
480		ELLISV154808	842	2873	£451.00	£541.20	£563.75	£676.50
540		ELLISV155409	948	3235	£498.00	£597.60	£622.50	£747.00
600		ELLISV156010	1053	3593	£538.00	£645.60	£672.50	£807.00
720		ELLISV157212	1264	4313	£659.00	£790.80	£823.75	£988.50
840		ELLISV158414	1474	5029	£782.00	£938.40	£977.50	£1,173.00
1820		240	ELLISV182404	502	1713	£310.00	£372.00	£387.50
	540	ELLISV185409	1130	3856	£516.00	£619.20	£645.00	£774.00
	720	ELLISV187212	1506	5138	£683.00	£819.60	£853.75	£1,024.50
	840	ELLISV188414	1757	5995	£809.00	£970.80	£1,011.25	£1,213.50
2020	240	ELLISV202404	556	1897	£325.00	£390.00	£406.25	£487.50
	300	ELLISV203005	695	2371	£349.00	£418.80	£436.25	£523.50
	480	ELLISV204808	1112	3794	£485.00	£582.00	£606.25	£727.50
	540	ELLISV205409	1251	4268	£572.00	£686.40	£715.00	£858.00
	600	ELLISV206010	1390	4743	£583.00	£699.60	£728.75	£874.50
	720	ELLISV207212	1668	5691	£759.00	£910.80	£948.75	£1,138.50
	840	ELLISV208414	1946	6640	£898.00	£1,077.60	£1,122.50	£1,347.00

\*Saving based on the value of individual items when bought separately.  
Order any of our selected valves & matching pipe covers at the same time as your radiator; PROMOVIW (white), PROMOVIC (chrome).



# Ellipsis Double Vertical shown on pages 48-49



High quality Italian design & manufacture.  
Steel; 25mm x 50mm oval tubes  
CE/UKCA approved & certified to BS EN442.



White RAL 9016 as standard, 188 RAL colours plus 30 Special Finishes  
Please call **01342 302250** for a RAL or Special Finish chart  
Colour Coordination Service available on stock sizes see pages 6-7 for full details.

## Stock White RAL 9016 & Textured Anthracite: 48-72 Hours

Made to Order sizes & colours: Up to 7 weeks.



**SAVE £45** WHEN YOU BUY OUR **IDEAL TRV KIT** WITH ANY DESIGNER ORDER\*  
QUOTE **PROMOVI** AT TIME OF ORDER

Available in White or Chrome

Pipe centres left to right	Pipe centres from wall	Depth from wall
width + valves	80mm-90mm	120mm-130mm

## Stock options White RAL 9016 - Double Vertical

Height (mm)	Width (mm)	Model	Watts Δt 50°C	Btu's Δt 50°C	White Ex VAT	White Inc VAT	Colours Ex VAT	Colours Inc VAT
DELIVERY TIMES					48-72 HOURS		UP TO 7 WEEKS	
1820	300	ELLIDV183005	951	3245	£547.00	£656.40	£683.75	£820.50
	420	ELLIDV184207	1331	4541	£637.00	£764.40	£796.25	£955.50
	480	ELLIDV184808	1521	5190	£720.00	£864.00	£900.00	£1,080.00
	600	ELLIDV186010	1901	6486	£889.00	£1,066.80	£1,111.25	£1,333.50

## Stock options Textured Anthracite - Double Vertical <sup>New</sup>

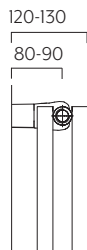

Height (mm)	Width (mm)	Model	Watts Δt 50°C	Btu's Δt 50°C	Textured Anthracite Ex VAT	Textured Anthracite Inc VAT
DELIVERY TIMES					48-72 HOURS	
1820	480	ELLIDV184808TA	1521	5190	£900.00	£1,080.00
	600	ELLIDV186010TA	1901	6486	£1,111.25	£1,333.50

## Made to order options - Double Vertical

Height (mm)	Width (mm)	Model	Watts Δt 50°C	Btu's Δt 50°C	White Ex VAT	White Inc VAT	Colours Ex VAT	Colours Inc VAT
DELIVERY TIMES					UP TO 7 WEEKS		UP TO 7 WEEKS	
520	300	ELLIDV523005	288	983	£371.00	£445.20	£463.75	£556.50
	480	ELLIDV524808	460	1570	£536.00	£643.20	£670.00	£804.00
	540	ELLIDV525409	518	1767	£637.00	£764.40	£796.25	£955.50
	600	ELLIDV526010	575	1962	£673.00	£807.60	£841.25	£1,009.50
	720	ELLIDV527212	690	2354	£744.00	£892.80	£930.00	£1,116.00
650	300	ELLIDV653005	359	1225	£471.00	£565.20	£588.75	£706.50
	480	ELLIDV654808	574	1958	£626.00	£751.20	£782.50	£939.00
	540	ELLIDV655409	646	2204	£680.00	£816.00	£850.00	£1,020.00
	600	ELLIDV656010	718	2450	£724.00	£868.80	£905.00	£1,086.00
	720	ELLIDV657212	862	2941	£796.00	£955.20	£995.00	£1,194.00
700	300	ELLIDV703005	387	1320	£479.00	£574.80	£598.75	£718.50
	480	ELLIDV704808	619	2112	£633.00	£759.60	£791.25	£949.50
	540	ELLIDV705409	697	2378	£688.00	£825.60	£860.00	£1,032.00
	600	ELLIDV706010	774	2641	£735.00	£882.00	£918.75	£1,102.50
	720	ELLIDV707212	929	3170	£829.00	£994.80	£1,036.25	£1,243.50
920	240	ELLIDV922404	402	1372	£368.00	£441.60	£460.00	£552.00
	300	ELLIDV923005	502	1713	£483.00	£579.60	£603.75	£724.50
	480	ELLIDV924808	803	2740	£641.00	£769.20	£801.25	£961.50
	540	ELLIDV925409	904	3084	£699.00	£838.80	£873.75	£1,048.50
	600	ELLIDV926010	1004	3426	£752.00	£902.40	£940.00	£1,128.00
1020	240	ELLIDV102404	441	1505	£387.00	£464.40	£483.75	£580.50
	300	ELLIDV103005	551	1880	£487.00	£584.40	£608.75	£730.50
	480	ELLIDV104808	882	3009	£649.00	£778.80	£811.25	£973.50
	540	ELLIDV105409	992	3385	£706.00	£847.20	£882.50	£1,059.00
	600	ELLIDV106010	1102	3760	£776.00	£931.20	£970.00	£1,164.00
1020	720	ELLIDV107212	1322	4511	£898.00	£1,077.60	£1,122.50	£1,347.00
	840	ELLIDV108414	1543	5265	£1,030.00	£1,236.00	£1,287.50	£1,545.00

Height (mm)	Width (mm)	Model	Watts Δt 50°C	Btu's Δt 50°C	White Ex VAT	White Inc VAT	Colours Ex VAT	Colours Inc VAT
DELIVERY TIMES					UP TO 7 WEEKS		UP TO 7 WEEKS	
1220	240	ELLIDV122404	520	1774	£407.00	£488.40	£508.75	£610.50
	300	ELLIDV123005	651	2221	£502.00	£602.40	£627.50	£753.00
	480	ELLIDV124808	1041	3552	£666.00	£799.20	£832.50	£999.00
	540	ELLIDV125409	1171	3995	£728.00	£873.60	£910.00	£1,092.00
	600	ELLIDV126010	1301	4439	£806.00	£967.20	£1,007.50	£1,209.00
	720	ELLIDV127212	1561	5326	£959.00	£1,150.80	£1,198.75	£1,438.50
	840	ELLIDV128414	1821	6213	£1,116.00	£1,339.20	£1,395.00	£1,674.00
	1520	240	ELLIDV152404	641	2187	£410.00	£492.00	£512.50
300		ELLIDV153005	802	2736	£512.00	£614.40	£640.00	£768.00
480		ELLIDV154808	1282	4374	£687.00	£824.40	£858.75	£1,030.50
540		ELLIDV155409	1443	4924	£741.00	£889.20	£926.25	£1,111.50
1820	240	ELLIDV182404	760	2593	£433.00	£519.60	£541.25	£649.50
	300	ELLIDV183005	921	3142	£535.00	£648.00	£670.00	£804.00
	480	ELLIDV184808	1521	5190	£720.00	£864.00	£900.00	£1,080.00
	540	ELLIDV185409	1682	5739	£774.00	£931.20	£968.75	£1,164.00
2020	240	ELLIDV202404	838	2859	£447.00	£536.40	£558.75	£670.50
	300	ELLIDV203005	1047	3572	£562.00	£674.40	£702.50	£843.00
	480	ELLIDV204808	1675	5715	£741.00	£889.20	£926.25	£1,111.50
	540	ELLIDV205409	1885	6432	£848.00	£1,017.60	£1,060.00	£1,272.00
	600	ELLIDV206010	2094	7145	£925.00	£1,110.00	£1,156.25	£1,387.50
	720	ELLIDV207212	2513	8574	£1,151.00	£1,381.20	£1,438.75	£1,726.50
	840	ELLIDV208414	2932	10004	£1,341.00	£1,609.20	£1,676.25	£2,011.50

\*Saving based on the value of individual items when bought separately.  
Order any of our selected valves & matching pipe covers at the same time as your radiator; PROMOVIW (white), PROMOVIC (chrome).

# Sitar Single Horizontal shown on pages 50-51



High quality Italian design & manufacture.  
Steel; 23mm round tubes  
CE/UKCA approved & certified to BS EN442.



White RAL 9016 as standard, 188 RAL colours plus 30 Special Finishes  
Please call **01342 302250** for a RAL or Special Finish chart  
Colour Coordination Service available on stock sizes see pages 6-7 for full details.

## Stock White RAL 9016: 48-72 Hours

Made to Order sizes & colours: Up to 5 weeks.



**SAVE £45** WHEN YOU BUY OUR **IDEAL TRV KIT** WITH ANY DESIGNER ORDER\*  
QUOTE **PROMOVI** AT TIME OF ORDER

Available in White or Chrome

Pipe centres left to right	Pipe centres from wall	Depth from wall
width - 50mm	55mm	90mm

## Stock options White RAL 9016 - Single Horizontal

Height (mm)	Width (mm)	Model	Watts Δt 50°C	Btu's Δt 50°C	White Ex VAT	White Inc VAT	Colours Ex VAT	Colours Inc VAT
DELIVERY TIMES					48-72 HOURS		UP TO 5 WEEKS	
402	920	SITASH409212	515	1757	£341.00	£409.20	£426.25	£511.50
	1220	SITASH401212	683	2330	£359.00	£430.80	£448.75	£538.50
	1520	SITASH401512	851	2904	£374.00	£448.80	£467.50	£561.00
504	520	SITASH505215	361	1232	£347.00	£416.40	£433.75	£520.50
	650	SITASH506515	451	1539	£356.00	£427.20	£445.00	£534.00
	700	SITASH507015	486	1658	£364.00	£436.80	£455.00	£546.00
	920	SITASH509215	639	2180	£376.00	£451.20	£470.00	£564.00
	1220	SITASH501215	848	2893	£397.00	£476.40	£496.25	£595.50
538	1520	SITASH501515	1056	3603	£414.00	£496.80	£517.50	£621.00
	920	SITASH539216	681	2324	£387.00	£464.40	£483.75	£580.50
	1220	SITASH531216	903	3081	£409.00	£490.80	£511.25	£613.50
	1520	SITASH531516	1124	3835	£429.00	£514.80	£536.25	£643.50
606	650	SITASH606518	537	1832	£387.00	£464.40	£483.75	£580.50
	700	SITASH607018	578	1972	£400.00	£480.00	£500.00	£600.00
	920	SITASH609218	760	2593	£417.00	£500.40	£521.25	£625.50
	1220	SITASH601218	1009	3443	£437.00	£524.40	£546.25	£655.50
1520	SITASH601518	1257	4289	£458.00	£549.60	£572.50	£687.00	

Single

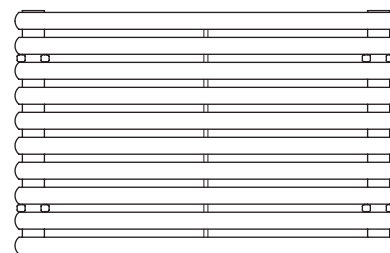
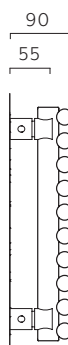

Made to order options - Single Horizontal

Height (mm)	Width (mm)	Model	Watts Δt 50°C	Btu's Δt 50°C	White Ex VAT	White Inc VAT	Colours Ex VAT	Colours Inc VAT
DELIVERY TIMES					UP TO 5 WEEKS		UP TO 5 WEEKS	
300	520	SITASH305209	218	744	£287.00	£344.40	£358.75	£430.50
	650	SITASH306509	272	928	£293.00	£351.60	£366.25	£439.50
	700	SITASH307009	293	1000	£299.00	£358.80	£373.75	£448.50
	920	SITASH309209	386	1317	£307.00	£368.40	£383.75	£460.50
	1220	SITASH301209	512	1747	£320.00	£384.00	£400.00	£480.00
	1520	SITASH301509	638	2177	£332.00	£398.40	£415.00	£498.00
	1820	SITASH301809	764	2607	£343.00	£411.60	£428.75	£514.50
	2020	SITASH302009	848	2893	£349.00	£418.80	£436.25	£523.50
402	520	SITASH405212	291	993	£315.00	£378.00	£393.75	£472.50
	650	SITASH406512	363	1239	£323.00	£387.60	£403.75	£484.50
	700	SITASH407012	391	1334	£328.00	£393.60	£410.00	£492.00
	1820	SITASH401812	1018	3473	£387.00	£464.40	£483.75	£580.50
	2020	SITASH402012	1130	3856	£397.00	£476.40	£496.25	£595.50
504	1820	SITASH501815	1265	4316	£433.00	£519.60	£541.25	£649.50
	2020	SITASH502015	1404	4790	£445.00	£534.00	£556.25	£667.50

Height (mm)	Width (mm)	Model	Watts Δt 50°C	Btu's Δt 50°C	White Ex VAT	White Inc VAT	Colours Ex VAT	Colours Inc VAT
DELIVERY TIMES					UP TO 5 WEEKS		UP TO 5 WEEKS	
606	1820	SITASH601818	1505	5135	£477.00	£572.40	£596.25	£715.50
	2020	SITASH602018	1670	5698	£491.00	£589.20	£613.75	£736.50
708	650	SITASH706521	620	2115	£416.00	£499.20	£520.00	£624.00
	700	SITASH707021	667	2276	£427.00	£512.40	£533.75	£640.50
	920	SITASH709221	877	2992	£447.00	£536.40	£558.75	£670.50
	1220	SITASH701221	1164	3972	£474.00	£568.80	£592.50	£711.00
	1520	SITASH701521	1450	4947	£499.00	£598.80	£623.75	£748.50
	1820	SITASH701821	1736	5923	£522.00	£626.40	£652.50	£783.00
	2020	SITASH702021	1927	6575	£536.00	£643.20	£670.00	£804.00
810	650	SITASH816524	700	2388	£447.00	£536.40	£558.75	£670.50
	700	SITASH817024	754	2573	£459.00	£550.80	£573.75	£688.50
	920	SITASH819224	991	3381	£479.00	£574.80	£598.75	£718.50
	1220	SITASH811224	1314	4483	£510.00	£612.00	£637.50	£765.00
	1520	SITASH811524	1637	5585	£538.00	£645.60	£672.50	£807.00
	1820	SITASH811824	1961	6691	£565.00	£678.00	£706.25	£847.50
	2020	SITASH812024	2176	7425	£585.00	£702.00	£731.25	£877.50

\*Saving based on the value of individual items when bought separately. Order any of our selected valves & matching pipe covers at the same time as your radiator; PROMOW (white), PROMOVIC (chrome).

# Sitar Double Horizontal shown on pages 50-51



High quality Italian design & manufacture.  
Steel; 23mm round tubes  
CE/UKCA approved & certified to BS EN442.



White RAL 9016 as standard, 188 RAL colours plus 30 Special Finishes  
Please call **01342 302250** for a RAL or Special Finish chart  
Colour Coordination Service available on stock sizes see pages 6-7 for full details.

## Stock White RAL 9016: 48-72 Hours

Made to Order sizes & colours: Up to 5 weeks.



**SAVE £45** WHEN YOU BUY OUR **IDEAL TRV KIT** WITH ANY DESIGNER ORDER\*  
QUOTE **PROMOVI** AT TIME OF ORDER

Available in White or Chrome

Pipe centres left to right	Pipe centres from wall	Depth from wall
width - 50mm	79mm to 89mm	114mm to 124mm

## Stock options White RAL 9016 - Double Horizontal

Height (mm)	Width (mm)	Model	Watts Δt 50°C	Btu's Δt 50°C	White Ex VAT	White Inc VAT	Colours Ex VAT	Colours Inc VAT
DELIVERY TIMES					48-72 HOURS		UP TO 5 WEEKS	
402	920	SITADH409212	782	2668	£534.00	£640.80	£667.50	£801.00
	1220	SITADH401212	1037	3538	£565.00	£678.00	£706.25	£847.50
	1520	SITADH401512	1292	4408	£597.00	£716.40	£746.25	£895.50
	1820	SITADH401812	1547	5278	£621.00	£745.20	£776.25	£931.50
504	520	SITADH505215	527	1798	£553.00	£663.60	£691.25	£829.50
	650	SITADH506515	658	2245	£561.00	£673.20	£701.25	£841.50
	700	SITADH507015	709	2419	£572.00	£686.40	£715.00	£858.00
	920	SITADH509215	937	3197	£586.00	£703.20	£732.50	£879.00
	1220	SITADH501215	1235	4214	£626.00	£751.20	£782.50	£939.00
	1520	SITADH501515	1540	5254	£664.00	£796.80	£830.00	£996.00
538	920	SITADH539216	955	3258	£604.00	£724.80	£755.00	£906.00
	1220	SITADH531216	1266	4320	£645.00	£774.00	£806.25	£967.50
	1520	SITADH531516	1577	5381	£685.00	£822.00	£856.25	£1,027.50
	606	650	SITADH606518	732	2498	£607.00	£728.40	£758.75
700		SITADH607018	789	2692	£620.00	£744.00	£775.00	£930.00
920		SITADH609218	1037	3538	£641.00	£769.20	£801.25	£961.50
1220		SITADH601218	1375	4692	£685.00	£822.00	£856.25	£1,027.50
1520		SITADH601518	1713	5845	£731.00	£877.20	£913.75	£1,096.50
1820		SITADH601818	2051	6998	£762.00	£914.40	£952.50	£1,143.00

Double

114-124

79-89

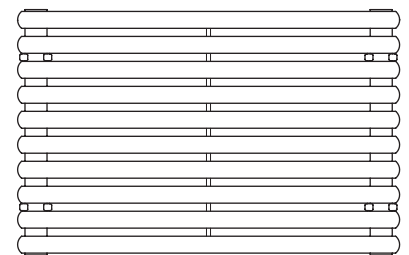
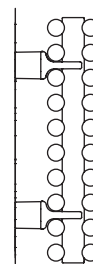

## Made to order options - Double Horizontal

Height (mm)	Width (mm)	Model	Watts Δt 50°C	Btu's Δt 50°C	White Ex VAT	White Inc VAT	Colours Ex VAT	Colours Inc VAT
DELIVERY TIMES					UP TO 5 WEEKS		UP TO 5 WEEKS	
300	520	SITADH305209	378	1290	£459.00	£550.80	£573.75	£688.50
	650	SITADH306509	473	1614	£463.00	£555.60	£578.75	£694.50
	700	SITADH307009	509	1737	£470.00	£564.00	£587.50	£705.00
	920	SITADH309209	669	2283	£486.00	£583.20	£607.50	£729.00
	1220	SITADH301209	887	3026	£509.00	£610.80	£636.25	£763.50
	1520	SITADH301509	1105	3770	£531.00	£637.20	£663.75	£796.50
	1820	SITADH301809	1323	4514	£548.00	£657.60	£685.00	£822.00
	2020	SITADH302009	1468	5009	£557.00	£668.40	£696.25	£835.50
402	520	SITADH405212	442	1508	£506.00	£607.20	£632.50	£759.00
	650	SITADH406512	552	1883	£511.00	£613.20	£638.75	£766.50
	700	SITADH407012	595	2030	£518.00	£621.60	£647.50	£777.00
	2020	SITADH402012	1717	5858	£633.00	£759.60	£791.25	£949.50
504	2020	SITADH502015	2046	6981	£709.00	£850.80	£886.25	£1,063.50
606	2020	SITADH602018	2276	7766	£785.00	£942.00	£981.25	£1,177.50

Height (mm)	Width (mm)	Model	Watts Δt 50°C	Btu's Δt 50°C	White Ex VAT	White Inc VAT	Colours Ex VAT	Colours Inc VAT
DELIVERY TIMES					UP TO 5 WEEKS		UP TO 5 WEEKS	
708	650	SITADH706521	829	2829	£657.00	£788.40	£821.25	£985.50
	700	SITADH707021	893	3047	£671.00	£805.20	£838.75	£1,006.50
	920	SITADH709221	1174	4006	£694.00	£832.80	£867.50	£1,041.00
	1220	SITADH701221	1556	5309	£746.00	£895.20	£932.50	£1,119.00
	1520	SITADH701521	1939	6616	£797.00	£956.40	£996.25	£1,195.50
	1820	SITADH701821	2322	7923	£833.00	£999.60	£1,041.25	£1,249.50
	2020	SITADH702021	2577	8793	£860.00	£1,032.00	£1,075.00	£1,290.00
	810	650	SITADH816524	901	3074	£706.00	£847.20	£882.50
700		SITADH817024	970	3310	£723.00	£867.60	£903.75	£1,084.50
920		SITADH819224	1275	4350	£749.00	£898.80	£936.25	£1,123.50
1220		SITADH811224	1691	5770	£807.00	£968.40	£1,008.75	£1,210.50
1520		SITADH811524	2107	7189	£862.00	£1,034.40	£1,077.50	£1,293.00
1820		SITADH811824	2523	8608	£905.00	£1,086.00	£1,131.25	£1,357.50
2020		SITADH812024	2800	9554	£933.00	£1,119.60	£1,166.25	£1,399.50

\*Saving based on the value of individual items when bought separately. Order any of our selected valves & matching pipe covers at the same time as your radiator; PROMOVIV (white), PROMOVIC (chrome).

# Sitar Single Vertical shown on pages 50-51



High quality Italian design & manufacture.  
Steel; 23mm round tubes  
CE/UKCA approved & certified to BS EN442.



White RAL 9016 as standard, 188 RAL colours plus 30 Special Finishes  
Please call **01342 302250** for a RAL or Special Finish chart  
Colour Coordination Service available on stock sizes see pages 6-7 for full details.

## Stock White RAL 9016: 48-72 Hours

Made to Order sizes & colours: Up to 5 weeks.



**SAVE £45** WHEN YOU BUY OUR IDEAL TRV KIT WITH ANY DESIGNER ORDER\*  
QUOTE **PROMOVI** AT TIME OF ORDER

Available in White or Chrome

Pipe centres left to right	Pipe centres from wall	Depth from wall
width + valves	55mm	90mm

## Stock options White RAL 9016 - Single Vertical

Height (mm)	Width (mm)	Model	Watts Δt 50°C	Btu's Δt 50°C	White Ex VAT	White Inc VAT	Colours Ex VAT	Colours Inc VAT
DELIVERY TIMES					48-72 HOURS		UP TO 5 WEEKS	
650	402	SITASV6540I2	384	1310	£323.00	£387.60	£403.75	£484.50
	504	SITASV6550I5	480	1638	£356.00	£427.20	£445.00	£534.00
1220	402	SITASVI240I2	660	2252	£359.00	£430.80	£448.75	£538.50
	504	SITASVI250I5	825	2815	£397.00	£476.40	£496.25	£595.50
	606	SITASVI260I8	990	3378	£437.00	£524.40	£546.25	£655.50
1520	232	SITASVI52307	469	1600	£305.00	£366.00	£381.25	£457.50
	300	SITASVI53009	603	2057	£332.00	£398.40	£415.00	£498.00
	402	SITASVI540I2	804	2743	£374.00	£448.80	£467.50	£561.00
	504	SITASVI550I5	1005	3429	£414.00	£496.80	£517.50	£621.00
	606	SITASVI560I8	1206	4115	£458.00	£549.60	£572.50	£687.00
1820	232	SITASVI82307	546	1863	£312.00	£374.40	£390.00	£468.00
	300	SITASVI83009	702	2395	£343.00	£411.60	£428.75	£514.50
	402	SITASVI840I2	936	3194	£387.00	£464.40	£483.75	£580.50
	504	SITASVI850I5	1170	3992	£433.00	£519.60	£541.25	£649.50
	606	SITASVI860I8	1404	4790	£477.00	£572.40	£596.25	£715.50
2020	708	SITASVI8702I	1638	5589	£522.00	£626.40	£652.50	£783.00
	402	SITASV2040I2	1032	3521	£397.00	£476.40	£496.25	£595.50
	504	SITASV2050I5	1290	4401	£445.00	£534.00	£556.25	£667.50
	606	SITASV2060I8	1548	5282	£491.00	£589.20	£613.75	£736.50

## Single

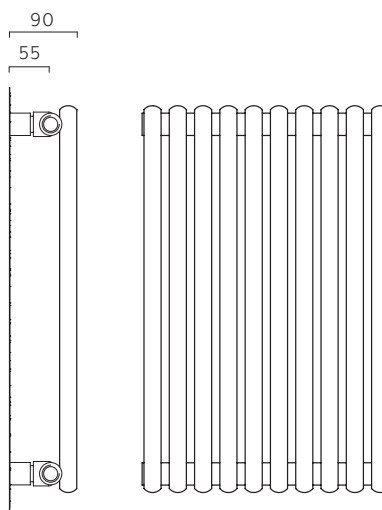

Underneath Connections	Ex VAT	Inc VAT
B2CONN	£136.00	£163.20
Underneath Connections are made to order only, stock lines are BOE.		
Underneath Connections pipe centres = width - 75mm		

## Made to order options - Single Vertical

Height (mm)	Width (mm)	Model	Watts Δt 50°C	Btu's Δt 50°C	White Ex VAT	White Inc VAT	Colours Ex VAT	Colours Inc VAT
DELIVERY TIMES					UP TO 5 WEEKS		UP TO 5 WEEKS	
520	300	SITASV523009	234	798	£287.00	£344.40	£358.75	£430.50
	402	SITASV5240I2	312	1065	£315.00	£378.00	£393.75	£472.50
	504	SITASV5250I5	390	1331	£347.00	£416.40	£433.75	£520.50
	606	SITASV5260I8	468	1597	£376.00	£451.20	£470.00	£564.00
	708	SITASV52702I	546	1863	£405.00	£486.00	£506.25	£607.50
650	300	SITASV653009	288	983	£293.00	£351.60	£366.25	£439.50
	606	SITASV6560I8	576	1965	£387.00	£464.40	£483.75	£580.50
	708	SITASV65702I	672	2293	£416.00	£499.20	£520.00	£624.00
750	300	SITASV753009	324	1105	£302.00	£362.40	£377.50	£453.00
	402	SITASV7540I2	432	1474	£331.00	£397.20	£413.75	£496.50
	504	SITASV7550I5	540	1842	£368.00	£441.60	£460.00	£552.00
	606	SITASV7560I8	648	2211	£407.00	£488.40	£508.75	£610.50
920	708	SITASV75702I	756	2579	£435.00	£522.00	£543.75	£652.50
	232	SITASV922307	301	1027	£286.00	£343.20	£357.50	£429.00
	300	SITASV923009	387	1320	£307.00	£368.40	£383.75	£460.50
	402	SITASV9240I2	516	1761	£341.00	£409.20	£426.25	£511.50

Height (mm)	Width (mm)	Model	Watts Δt 50°C	Btu's Δt 50°C	White Ex VAT	White Inc VAT	Colours Ex VAT	Colours Inc VAT
DELIVERY TIMES					UP TO 5 WEEKS		UP TO 5 WEEKS	
920	504	SITASV9250I5	645	2201	£376.00	£451.20	£470.00	£564.00
	606	SITASV9260I8	774	2641	£417.00	£500.40	£521.25	£625.50
	708	SITASV92702I	903	3081	£447.00	£536.40	£558.75	£670.50
	810	SITASV928I24	1032	3521	£479.00	£574.80	£598.75	£718.50
1220	232	SITASVI22307	385	1314	£294.00	£352.80	£367.50	£441.00
	300	SITASVI23009	495	1689	£320.00	£384.00	£400.00	£480.00
	708	SITASVI2702I	1155	3941	£474.00	£568.80	£592.50	£711.00
1520	810	SITASVI28I24	1320	4504	£510.00	£612.00	£637.50	£765.00
	708	SITASVI5702I	1407	4801	£499.00	£598.80	£623.75	£748.50
1820	810	SITASVI58I24	1608	5486	£538.00	£645.60	£672.50	£807.00
	810	SITASVI88I24	1872	6387	£565.00	£678.00	£706.25	£847.50
2020	232	SITASV202307	602	2054	£319.00	£382.80	£398.75	£478.50
	300	SITASV203009	774	2641	£349.00	£418.80	£436.25	£523.50
	708	SITASV20702I	1806	6162	£536.00	£643.20	£670.00	£804.00
	810	SITASV208I24	2064	7042	£585.00	£702.00	£731.25	£877.50

\*Saving based on the value of individual items when bought separately. Order any of our selected valves & matching pipe covers at the same time as your radiator; PROMOVIW (white), PROMOVIC (chrome).

# Sitar Double Vertical shown on pages 50-51



High quality Italian design & manufacture.  
Steel; 23mm round tubes  
CE/UKCA approved & certified to BS EN442.



White RAL 9016 as standard, 188 RAL colours plus 30 Special Finishes  
Please call **01342 302250** for a RAL or Special Finish chart  
Colour Coordination Service available on stock sizes see pages 6-7 for full details.

**Stock White RAL 9016: 48-72 Hours**  
Made to Order sizes & colours: Up to 5 weeks.



**SAVE £45** WHEN YOU BUY OUR **IDEAL TRV KIT** WITH ANY DESIGNER ORDER\*  
QUOTE **PROMOVI** AT TIME OF ORDER

Available in White or Chrome

Pipe centres left to right	Pipe centres from wall	Depth from wall
width + valves	79mm to 89mm	114mm to 124mm

## Stock options White RAL 9016 - Double Vertical

Height (mm)	Width (mm)	Model	Watts Δt 50°C	Btu's Δt 50°C	White Ex VAT	White Inc VAT	Colours Ex VAT	Colours Inc VAT
DELIVERY TIMES					48-72 HOURS		UP TO 5 WEEKS	
650	402	SITADV654012	576	1965	£511.00	£613.20	£638.75	£766.50
	504	SITADV655015	720	2457	£561.00	£673.20	£701.25	£841.50
1220	402	SITADV124012	960	3276	£565.00	£678.00	£706.25	£847.50
	504	SITADV125015	1200	4094	£626.00	£751.20	£782.50	£939.00
1520	232	SITADV152307	686	2341	£486.00	£583.20	£607.50	£729.00
	300	SITADV153009	882	3009	£531.00	£637.20	£663.75	£796.50
	402	SITADV154012	1176	4013	£597.00	£716.40	£746.25	£895.50
	504	SITADV155015	1470	5016	£664.00	£796.80	£830.00	£996.00
1820	606	SITADV156018	1764	6019	£731.00	£877.20	£913.75	£1,096.50
	232	SITADV182307	819	2794	£499.00	£598.80	£623.75	£748.50
	300	SITADV183009	1053	3593	£548.00	£657.60	£685.00	£822.00
	402	SITADV184012	1404	4790	£621.00	£745.20	£776.25	£931.50
	504	SITADV185015	1755	5988	£690.00	£828.00	£862.50	£1,035.00
	606	SITADV186018	2106	7186	£762.00	£914.40	£952.50	£1,143.00
2020	708	SITADV187021	2457	8383	£833.00	£999.60	£1,041.25	£1,249.50
	402	SITADV204012	1572	5364	£633.00	£759.60	£791.25	£949.50
	504	SITADV205015	1965	6705	£709.00	£850.80	£886.25	£1,063.50
	606	SITADV206018	2358	8045	£785.00	£942.00	£981.25	£1,177.50

Double

114-124

79-89

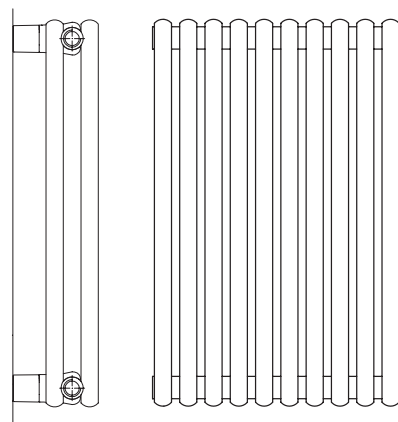

Underneath Connections	Ex VAT	Inc VAT
B2CONN	£136.00	£163.20
Underneath Connections are made to order only, stock lines are BOE.		
Underneath Connections pipe centres = width - 75mm		

## Made to order options - Double Vertical

Height (mm)	Width (mm)	Model	Watts Δt 50°C	Btu's Δt 50°C	White Ex VAT	White Inc VAT	Colours Ex VAT	Colours Inc VAT
DELIVERY TIMES					UP TO 5 WEEKS		UP TO 5 WEEKS	
520	300	SITADV523009	360	1228	£459.00	£550.80	£573.75	£688.50
	402	SITADV524012	480	1638	£506.00	£607.20	£632.50	£759.00
	504	SITADV525015	600	2047	£553.00	£663.60	£691.25	£829.50
	606	SITADV526018	720	2457	£601.00	£721.20	£751.25	£901.50
	708	SITADV527021	840	2866	£646.00	£775.20	£807.50	£969.00
650	300	SITADV653009	432	1474	£463.00	£555.60	£578.75	£694.50
	606	SITADV656018	864	2948	£607.00	£728.40	£758.75	£910.50
	708	SITADV657021	1008	3439	£657.00	£788.40	£821.25	£985.50
750	300	SITADV753009	477	1628	£475.00	£570.00	£593.75	£712.50
	402	SITADV754012	636	2170	£521.00	£625.20	£651.25	£781.50
	504	SITADV755015	795	2713	£576.00	£691.20	£720.00	£864.00
	606	SITADV756018	954	3255	£623.00	£747.60	£778.75	£934.50
920	708	SITADV757021	1113	3798	£676.00	£811.20	£845.00	£1,014.00
	232	SITADV922307	441	1505	£452.00	£542.40	£565.00	£678.00
	300	SITADV923009	567	1935	£486.00	£583.20	£607.50	£729.00
	402	SITADV924012	756	2579	£534.00	£640.80	£667.50	£801.00
DELIVERY TIMES					UP TO 5 WEEKS		UP TO 5 WEEKS	
920	504	SITADV925015	945	3224	£574.00	£688.80	£717.50	£861.00
	606	SITADV926018	1134	3869	£630.00	£756.00	£787.50	£945.00
	708	SITADV927021	1323	4514	£681.00	£817.20	£851.25	£1,021.50
	810	SITADV928124	1512	5159	£735.00	£882.00	£918.75	£1,102.50
1220	232	SITADV122307	560	1911	£469.00	£562.80	£586.25	£703.50
	300	SITADV123009	720	2457	£509.00	£610.80	£636.25	£763.50
	606	SITADV126018	1440	4913	£685.00	£822.00	£856.25	£1,027.50
	708	SITADV127021	1680	5732	£746.00	£895.20	£932.50	£1,119.00
1520	810	SITADV128124	1920	6551	£807.00	£968.40	£1,008.75	£1,210.50
	708	SITADV157021	2058	7022	£797.00	£956.40	£996.25	£1,195.50
	810	SITADV158124	2352	8025	£862.00	£1,034.40	£1,077.50	£1,293.00
1820	810	SITADV188124	2808	9581	£905.00	£1,086.00	£1,131.25	£1,357.50
	232	SITADV202307	917	3129	£509.00	£610.80	£636.25	£763.50
	300	SITADV203009	1179	4023	£557.00	£668.40	£696.25	£835.50
	708	SITADV207021	2751	9386	£860.00	£1,032.00	£1,075.00	£1,290.00
2020	810	SITADV208124	3144	10727	£933.00	£1,119.60	£1,166.25	£1,399.50

\*Saving based on the value of individual items when bought separately. Order any of our selected valves & matching pipe covers at the same time as your radiator; PROMOVIW (white), PROMOVIC (chrome).

# Sax<sup>®</sup> Horizontal shown on pages 52-53



High quality Italian design & manufacture.  
Steel; 20mm x 25mm tubes with 30mm collectors  
CE/UKCA approved & certified to BS EN442.

White RAL 9016 as standard, 188 RAL colours plus 30 Special Finishes  
Please call **01342 302250** for a RAL or Special Finish chart  
Colour Coordination Service available on stock sizes see pages 6-7 for full details.

**Stock White RAL 9016: 48-72 Hours**  
Made to Order sizes & colours: Up to 5 weeks



**SAVE £45** WHEN YOU BUY OUR **IDEAL TRV KIT** WITH ANY DESIGNER ORDER\*  
QUOTE **PROMOVI** AT TIME OF ORDER

Available in White or Chrome

## Stock options White RAL 9016 - Single Horizontal

Height (mm)	Width (mm)	Model	Watts Δt50°C	Btu's Δt50°C	White Ex VAT	White Inc VAT	Colours Ex VAT	Colours Inc VAT
DELIVERY TIMES					48-72 HOURS		UP TO 5 WEEKS	
520	1200	SAXSH521213	799	2726	£535.00	£642.00	£668.75	£802.50
600	900	SAXSH609015	686	2341	£537.00	£644.40	£671.25	£805.50
	1200	SAXSH601215	915	3122	£570.00	£684.00	£712.50	£855.00

Pipe centres left to right	Pipe centres from wall	Depth from wall
width - 30mm	55mm	95mm

Made to order options - Single Horizontal

Height (mm)	Width (mm)	Model	Watts Δt 50°C	Btu's Δt 50°C	White Ex VAT	White Inc VAT	Colours Ex VAT	Colours Inc VAT
DELIVERY TIMES					UP TO 5 WEEKS		UP TO 5 WEEKS	
400	900	SAXSH409010	465	1587	£443.00	£531.60	£553.75	£664.50
	1200	SAXSH401210	621	2119	£463.00	£555.60	£578.75	£694.50
	1500	SAXSH401510	776	2648	£486.00	£583.20	£607.50	£729.00
	1800	SAXSH401810	931	3177	£504.00	£604.80	£630.00	£756.00
520	900	SAXSH529013	599	2044	£504.00	£604.80	£630.00	£756.00
	1500	SAXSH521513	999	3409	£564.00	£676.80	£705.00	£846.00
	1800	SAXSH521813	1199	4091	£585.00	£702.00	£731.25	£877.50
600	1500	SAXSH601515	1144	3903	£603.00	£723.60	£753.75	£904.50
	1800	SAXSH601815	1373	4685	£631.00	£757.20	£788.75	£946.50

Single

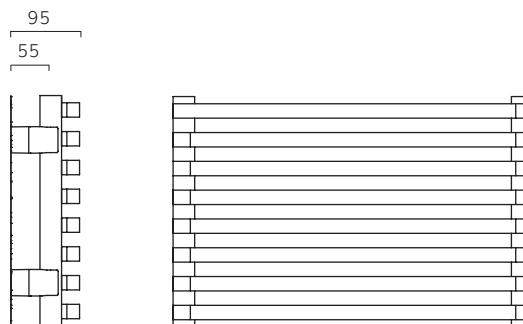

## Stock options White RAL 9016 - Double Horizontal

Height (mm)	Width (mm)	Model	Watts Δt 50°C	Btu's Δt 50°C	White Ex VAT	White Inc VAT	Colours Ex VAT	Colours Inc VAT
DELIVERY TIMES					48-72 HOURS		UP TO 5 WEEKS	
520	1200	SAXDH521213	1272	4340	£994.00	£1,192.80	£1,242.50	£1,491.00
600	900	SAXDH609015	1066	3637	£1,010.00	£1,212.00	£1,262.50	£1,515.00
	1200	SAXDH601215	1422	4852	£1,062.00	£1,274.40	£1,327.50	£1,593.00

Pipe centres left to right	Pipe centres from wall	Depth from wall
width - 30mm	76mm to 82mm	116mm to 122mm

Made to order options - Double Horizontal

Height (mm)	Width (mm)	Model	Watts Δt 50°C	Btu's Δt 50°C	White Ex VAT	White Inc VAT	Colours Ex VAT	Colours Inc VAT
DELIVERY TIMES					UP TO 5 WEEKS		UP TO 5 WEEKS	
400	900	SAXDH409010	777	2651	£827.00	£992.40	£1,033.75	£1,240.50
	1200	SAXDH401210	1036	3535	£862.00	£1,034.40	£1,077.50	£1,293.00
	1500	SAXDH401510	1295	4419	£897.00	£1,076.40	£1,121.25	£1,345.50
	1800	SAXDH401810	1554	5302	£961.00	£1,153.20	£1,201.25	£1,441.50
520	900	SAXDH529013	954	3255	£947.00	£1,136.40	£1,183.75	£1,420.50
	1500	SAXDH521513	1591	5428	£1,040.00	£1,248.00	£1,300.00	£1,560.00
	1800	SAXDH521813	1909	6514	£1,113.00	£1,335.60	£1,391.25	£1,669.50
600	1500	SAXDH601515	1777	6063	£1,113.00	£1,335.60	£1,391.25	£1,669.50
	1800	SAXDH601815	2133	7278	£1,190.00	£1,428.00	£1,487.50	£1,785.00

Double

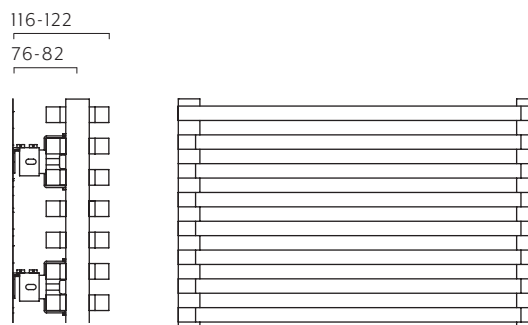

® Sax is an IRSAP Group registered design

\*Saving based on the value of individual items when bought separately.  
Order any of our selected valves & matching pipe covers at the same time as your radiator; PROMOW (white), PROMOVIC (chrome).

# Sax® Vertical shown on pages 52-53



High quality Italian design & manufacture.  
Steel; 20mm x 25mm tubes with 30mm collectors  
CE/UKCA approved & certified to BS EN442.



White RAL 9016 as standard, 188 RAL colours plus 30 Special Finishes  
Please call **01342 302250** for a RAL or Special Finish chart  
Colour Coordination Service available on stock sizes see pages 6-7 for full details.

**Stock White RAL 9016: 48-72 Hours**  
Made to Order sizes & colours: Up to 5 weeks.



**SAVE £45** WHEN YOU BUY OUR **IDEAL TRV KIT** WITH ANY DESIGNER ORDER\*  
QUOTE **PROMOVI** AT TIME OF ORDER

Available in White or Chrome

## Stock options White RAL 9016 - Single Vertical

Height (mm)	Width (mm)	Model	Watts Δt 50°C	Btu's Δt 50°C	White Ex VAT	White Inc VAT	Colours Ex VAT	Colours Inc VAT
DELIVERY TIMES					48-72 HOURS		UP TO 5 WEEKS	
1800	400	SAXSV184010	861	2938	£504.00	£604.80	£630.00	£756.00
	520	SAXSV185213	1119	3818	£585.00	£702.00	£731.25	£877.50

Made to order options - Single Vertical

Height (mm)	Width (mm)	Model	Watts Δt 50°C	Btu's Δt 50°C	White Ex VAT	White Inc VAT	Colours Ex VAT	Colours Inc VAT
DELIVERY TIMES					UP TO 5 WEEKS		UP TO 5 WEEKS	
1200	280	SAXSV122807	411	1402	£427.00	£512.40	£533.75	£640.50
	400	SAXSV124010	588	2006	£463.00	£555.60	£578.75	£694.50
	520	SAXSV125213	764	2607	£535.00	£642.00	£668.75	£802.50
	600	SAXSV126015	882	3009	£570.00	£684.00	£712.50	£855.00
1500	280	SAXSV152807	506	1726	£446.00	£535.20	£557.50	£669.00
	400	SAXSV154010	723	2467	£486.00	£583.20	£607.50	£729.00
	520	SAXSV155213	940	3207	£564.00	£676.80	£705.00	£846.00
	600	SAXSV156015	1085	3702	£603.00	£723.60	£753.75	£904.50
1800	280	SAXSV182807	603	2057	£460.00	£552.00	£575.00	£690.00
	600	SAXSV186015	1292	4408	£631.00	£757.20	£788.75	£946.50
2000	280	SAXSV202807	669	2283	£470.00	£564.00	£587.50	£705.00
	400	SAXSV204010	955	3258	£513.00	£615.60	£641.25	£769.50
	520	SAXSV205213	1242	4238	£603.00	£723.60	£753.75	£904.50
	600	SAXSV206015	1433	4889	£647.00	£776.40	£808.75	£970.50

Single



Pipe centres left to right	Pipe centres from wall	Depth from wall
width + valves	55mm	95mm

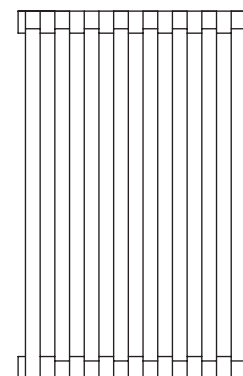
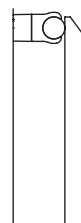

## Stock options White RAL 9016 - Double Vertical

Height (mm)	Width (mm)	Model	Watts Δt 50°C	Btu's Δt 50°C	White Ex VAT	White Inc VAT	Colours Ex VAT	Colours Inc VAT
DELIVERY TIMES					48-72 HOURS		UP TO 5 WEEKS	
1800	400	SAXDV184010	1356	4627	£961.00	£1,153.20	£1,201.25	£1,441.50
	520	SAXDV185213	1762	6012	£1,113.00	£1,335.60	£1,391.25	£1,669.50

Made to order options - Double Vertical

Height (mm)	Width (mm)	Model	Watts Δt 50°C	Btu's Δt 50°C	White Ex VAT	White Inc VAT	Colours Ex VAT	Colours Inc VAT
DELIVERY TIMES					UP TO 5 WEEKS		UP TO 5 WEEKS	
1200	280	SAXDV122807	668	2279	£797.00	£956.40	£996.25	£1,195.50
	400	SAXDV124010	954	3255	£862.00	£1,034.40	£1,077.50	£1,293.00
	520	SAXDV125213	1240	4231	£994.00	£1,192.80	£1,242.50	£1,491.00
	600	SAXDV126015	1431	4883	£1,062.00	£1,274.40	£1,327.50	£1,593.00
1500	280	SAXDV152807	811	2767	£823.00	£987.60	£1,028.75	£1,234.50
	400	SAXDV154010	1159	3955	£897.00	£1,076.40	£1,121.25	£1,345.50
	520	SAXDV155213	1507	5142	£1,040.00	£1,248.00	£1,300.00	£1,560.00
	600	SAXDV156015	1738	5930	£1,113.00	£1,335.60	£1,391.25	£1,669.50

Double

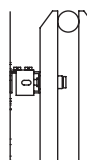

Pipe centres left to right	Pipe centres from wall	Depth from wall
width + valves	76mm to 82mm	116mm to 122mm

Height (mm)	Width (mm)	Model	Watts Δt 50°C	Btu's Δt 50°C	White Ex VAT	White Inc VAT	Colours Ex VAT	Colours Inc VAT
DELIVERY TIMES					UP TO 5 WEEKS		UP TO 5 WEEKS	
1800	280	SAXDV182807	949	3238	£882.00	£1,058.40	£1,102.50	£1,323.00
	600	SAXDV186015	2033	6937	£1,190.00	£1,428.00	£1,487.50	£1,785.00
2000	280	SAXDV202807	1038	3542	£942.00	£1,130.40	£1,177.50	£1,413.00
	400	SAXDV204010	1483	5060	£1,024.00	£1,228.80	£1,280.00	£1,536.00
	520	SAXDV205213	1927	6575	£1,187.00	£1,424.40	£1,483.75	£1,780.50
	600	SAXDV206015	2224	7588	£1,272.00	£1,526.40	£1,590.00	£1,908.00

\*Sax is an IRSAP Group registered design

\*Saving based on the value of individual items when bought separately.

Order any of our selected valves & matching pipe covers at the same time as your radiator; PROMOVIW (white), PROMOVIC (chrome).





# Piano Vertical shown on pages 54-55

High quality Italian design & manufacture.  
Steel; 50mm flat tubes with 30mm collectors  
CE/UKCA approved & certified to BS EN442.



White RAL 9016 as standard, 188 RAL colours plus 30 Special Finishes  
Please call **01342 302250** for a RAL or Special Finish chart  
Colour Coordination Service available on stock sizes see pages 6-7 for full details.

**Stock White RAL 9016: 48-72 Hours**  
Made to Order sizes & colours: Up to 5 weeks.



**SAVE £45** WHEN YOU BUY OUR **IDEAL TRV KIT** WITH ANY DESIGNER ORDER\*  
QUOTE **PROMOVI** AT TIME OF ORDER  
Available in White or Chrome

Pipe centres left to right	Pipe centres from wall	Depth from wall
width + valves	55mm	78mm

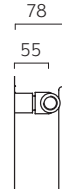

Pipe centres left to right	Pipe centres from wall	Depth from wall
width + valves	78mm - 84mm	97mm - 107mm

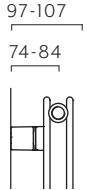

## Stock options White RAL 9016 - Single Vertical

Height (mm)	Width (mm)	Model	Watts Δt 50°C	Btu's Δt 50°C	White Ex VAT	White Inc VAT	Colours Ex VAT	Colours Inc VAT
DELIVERY TIMES					48-72 HOURS		UP TO 5 WEEKS	
1220	512	PIANSV125109	675	2303	£477.00	£572.40	£596.25	£715.50
1520	288	PIANSV152805	462	1576	£458.00	£549.60	£572.50	£687.00
	400	PIANSV154007	647	2208	£482.00	£578.40	£602.50	£723.00
	512	PIANSV155109	832	2839	£531.00	£637.20	£663.75	£796.50
	624	PIANSV156211	1017	3470	£585.00	£702.00	£731.25	£877.50
1820	288	PIANSV182805	550	1877	£471.00	£565.20	£588.75	£706.50
	400	PIANSV184007	769	2624	£500.00	£600.00	£625.00	£750.00
	512	PIANSV185109	989	3374	£555.00	£666.00	£693.75	£832.50
	624	PIANSV186211	1209	4125	£610.00	£732.00	£762.50	£915.00

## Stock options White RAL 9016 - Double Vertical

Height (mm)	Width (mm)	Model	Watts Δt 50°C	Btu's Δt 50°C	White Ex VAT	White Inc VAT	Colours Ex VAT	Colours Inc VAT
DELIVERY TIMES					48-72 HOURS		UP TO 5 WEEKS	
1220	512	PIANDV125109	973	3320	£788.00	£945.60	£985.00	£1,182.00
1520	288	PIANDV152805	660	2252	£751.00	£901.20	£938.75	£1,126.50
	400	PIANDV154007	924	3153	£779.00	£934.80	£973.75	£1,168.50
	512	PIANDV155109	1189	4057	£860.00	£1,032.00	£1,075.00	£1,290.00
	624	PIANDV156211	1453	4958	£953.00	£1,143.60	£1,191.25	£1,429.50
1820	288	PIANDV182805	778	2655	£779.00	£934.80	£973.75	£1,168.50
	400	PIANDV184007	1090	3719	£821.00	£985.20	£1,026.25	£1,231.50
	512	PIANDV185109	1401	4780	£905.00	£1,086.00	£1,131.25	£1,357.50
	624	PIANDV186211	1712	5841	£995.00	£1,194.00	£1,243.75	£1,492.50

## Made to order options - Single Vertical

Height (mm)	Width (mm)	Model	Watts Δt 50°C	Btu's Δt 50°C	White Ex VAT	White Inc VAT	Colours Ex VAT	Colours Inc VAT
DELIVERY TIMES					UP TO 5 WEEKS		UP TO 5 WEEKS	
520	400	PIANSV524007	239	815	£361.00	£433.20	£451.25	£541.50
	512	PIANSV525109	307	1047	£393.00	£471.60	£491.25	£589.50
	624	PIANSV526211	375	1280	£425.00	£510.00	£531.25	£637.50
	736	PIANSV527313	443	1512	£449.00	£538.80	£561.25	£673.50
	848	PIANSV528415	511	1744	£482.00	£578.40	£602.50	£723.00
920	288	PIANSV922805	286	976	£372.00	£446.40	£465.00	£558.00
	400	PIANSV924007	401	1368	£384.00	£460.80	£480.00	£576.00
	512	PIANSV925109	515	1757	£422.00	£506.40	£527.50	£633.00
	624	PIANSV926211	630	2150	£460.00	£552.00	£575.00	£690.00
1220	288	PIANSV122805	375	1280	£414.00	£496.80	£517.50	£621.00
	400	PIANSV124007	525	1791	£432.00	£518.40	£540.00	£648.00
	624	PIANSV126211	825	2815	£522.00	£626.40	£652.50	£783.00
1820	456	PIANSV184508	879	2999	£500.00	£600.00	£625.00	£750.00
2020	288	PIANSV202805	608	2074	£479.00	£574.80	£598.75	£718.50
	400	PIANSV204007	851	2904	£549.00	£658.80	£686.25	£823.50
	456	PIANSV204508	973	3320	£549.00	£658.80	£686.25	£823.50
	512	PIANSV205109	1095	3736	£566.00	£679.20	£707.50	£849.00
	624	PIANSV206211	1338	4565	£629.00	£754.80	£786.25	£943.50

## Made to order options - Double Vertical

Height (mm)	Width (mm)	Model	Watts Δt 50°C	Btu's Δt 50°C	White Ex VAT	White Inc VAT	Colours Ex VAT	Colours Inc VAT
DELIVERY TIMES					UP TO 5 WEEKS		UP TO 5 WEEKS	
520	400	PIANDV524007	351	1198	£613.00	£735.60	£766.25	£919.50
	512	PIANDV525109	452	1542	£669.00	£802.80	£836.25	£1,003.50
	624	PIANDV526211	552	1883	£723.00	£867.60	£903.75	£1,084.50
	736	PIANDV527313	652	2225	£762.00	£914.40	£952.50	£1,143.00
	848	PIANDV528415	753	2569	£821.00	£985.20	£1,026.25	£1,231.50
920	288	PIANDV922805	419	1430	£632.00	£758.40	£790.00	£948.00
	400	PIANDV924007	587	2003	£664.00	£796.80	£830.00	£996.00
	512	PIANDV925109	754	2573	£717.00	£860.40	£896.25	£1,075.50
	624	PIANDV926211	922	3146	£783.00	£939.60	£978.75	£1,174.50
1220	288	PIANDV122805	541	1846	£690.00	£828.00	£862.50	£1,035.00
	400	PIANDV124007	757	2583	£717.00	£860.40	£896.25	£1,075.50
	624	PIANDV126211	1190	4060	£864.00	£1,036.80	£1,080.00	£1,296.00
1820	456	PIANDV184508	1245	4248	£821.00	£985.20	£1,026.25	£1,231.50
2020	288	PIANDV202805	857	2924	£801.00	£961.20	£1,001.25	£1,201.50
	400	PIANDV204007	1199	4091	£851.00	£1,021.20	£1,063.75	£1,276.50
	456	PIANDV204508	1370	4674	£851.00	£1,021.20	£1,063.75	£1,276.50
	512	PIANDV205109	1542	5261	£944.00	£1,132.80	£1,180.00	£1,416.00
	624	PIANDV206211	1884	6428	£1,038.00	£1,245.60	£1,297.50	£1,557.00

\*Saving based on the value of individual items when bought separately. Order any of our selected valves & matching pipe covers at the same time as your radiator; PROMOVIW (white), PROMOVIC (chrome).

# Water Lily shown on page 56

High quality Italian design & manufacture.  
Steel; 70mm flat tubes with 30mm collectors  
Underneath (B2) connections as standard  
CE/UKCA approved & certified to BS EN442.

White RAL 9016 as standard, 188 RAL colours plus 30 Special Finishes  
Please call **01342 302250** for a RAL or Special Finish chart.

## Stock White RAL 9016: 48-72 Hours

Made to Order sizes & colours: Up to 5 weeks.



**SAVE £45** WHEN YOU BUY OUR **IDEAL TRV KIT** WITH ANY DESIGNER ORDER\*  
QUOTE **PROMOVI** AT TIME OF ORDER

Available in White or Chrome

Water Lily	Pipe centres left to right	Pipe centres from wall	Depth from wall
Water Lily Single	width - 84mm	55mm - 65mm	79mm - 89mm
Water Lily Double	width - 84mm	67mm - 77mm	91mm - 101mm

Please note: underneath connections only

## Stock options White RAL 9016 - Single Vertical

Height (mm)	Width (mm)	Model	Watts Δt 50°C	Btu's Δt 50°C	White Ex VAT	White Inc VAT	Colours Ex VAT	Colours Inc VAT
DELIVERY TIMES					48-72 HOURS		UP TO 5 WEEKS	
1820	160	WATESI81602	294	1003	£259.00	£310.80	£323.75	£388.50
	236	WATESI82303	441	1505	£303.00	£363.60	£378.75	£454.50
	312	WATESI83104	588	2006	£336.00	£403.20	£420.00	£504.00
	388	WATESI83805	735	2508	£389.00	£466.80	£486.25	£583.50
2020	464	WATESI84606	881	3006	£444.00	£532.80	£555.00	£666.00
	160	WATES201602	328	1119	£447.00	£536.40	£558.75	£670.50
	236	WATES202303	492	1679	£497.00	£596.40	£621.25	£745.50
	312	WATES203104	656	2238	£545.00	£654.00	£681.25	£817.50
	388	WATES203805	820	2798	£604.00	£724.80	£755.00	£906.00
	464	WATES204606	984	3357	£664.00	£796.80	£830.00	£996.00

79-89

55-65

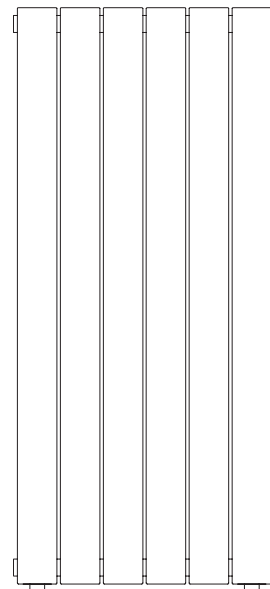

## Stock options White RAL 9016 - Double Vertical

Height (mm)	Width (mm)	Model	Watts Δt 50°C	Btu's Δt 50°C	White Ex VAT	White Inc VAT	Colours Ex VAT	Colours Inc VAT
DELIVERY TIMES					48-72 HOURS		UP TO 5 WEEKS	
1820	160	WATEDI81602	420	1433	£451.00	£541.20	£563.75	£676.50
	236	WATEDI82303	630	2150	£535.00	£642.00	£668.75	£802.50
	312	WATEDI83104	840	2866	£601.00	£721.20	£751.25	£901.50
	388	WATEDI83805	1050	3583	£699.00	£838.80	£873.75	£1,048.50
2020	464	WATEDI84606	1259	4296	£795.00	£954.00	£993.75	£1,192.50
	160	WATED201602	466	1590	£651.00	£781.20	£813.75	£976.50
	236	WATED202303	699	2385	£727.00	£872.40	£908.75	£1,090.50
	312	WATED203104	932	3180	£810.00	£972.00	£1,012.50	£1,215.00
	388	WATED203805	1166	3978	£893.00	£1,071.60	£1,116.25	£1,339.50
	464	WATED204606	1399	4773	£1,007.00	£1,208.40	£1,258.75	£1,510.50

91-101

67-77

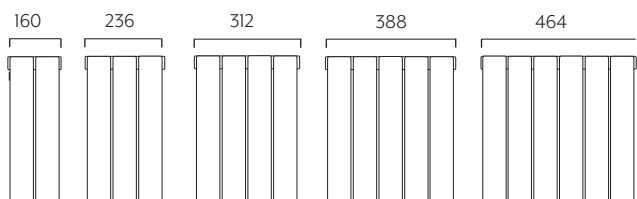

\*Saving based on the value of individual items when bought separately. Order any of our selected valves & matching pipe covers at the same time as your radiator; PROMOVIW (white), PROMOVIC (chrome).

# Immagina shown on page 57

High quality Italian design & manufacture.  
 Steel; optional built in colour changing LED lights with a remote control  
 Supplied with a 12v transformer  
 CE/UKCA approved & certified to BS EN442.



White RAL 9016 as standard, 188 RAL colours plus 30 Special Finishes  
 Please call **01342 302250** for a RAL or Special Finish chart.

Made to Order sizes & colours: Up to 5 weeks.

Pipe centres left to right	Pipe centres from wall	Depth from wall
50mm	57mm - 67mm	115mm - 125mm

Made to order options - Immagina without LED

Height (mm)	Width (mm)	Model	Watts Δt 50°C	Btu's Δt 50°C	White Ex VAT	White Inc VAT	Colours Ex VAT	Colours Inc VAT
DELIVERY TIMES					UP TO 5 WEEKS		UP TO 5 WEEKS	
1800	500	IMMAI850	769	2624	£2,842.00	£3,410.40	£3,552.50	£4,263.00
2000	600	IMMA2060	1009	3443	£3,315.00	£3,978.00	£4,143.75	£4,972.50

Made to order options - Immagina with LED

Height (mm)	Width (mm)	Model	Watts Δt 50°C	Btu's Δt 50°C	White Ex VAT	White Inc VAT	Colours Ex VAT	Colours Inc VAT
DELIVERY TIMES					UP TO 5 WEEKS		UP TO 5 WEEKS	
1800	500	IMMLED1850	769	2624	£4,546.00	£5,455.20	£5,256.50	£6,307.80
2000	600	IMMLED2060	1009	3443	£5,019.00	£6,022.80	£5,847.75	£7,017.30

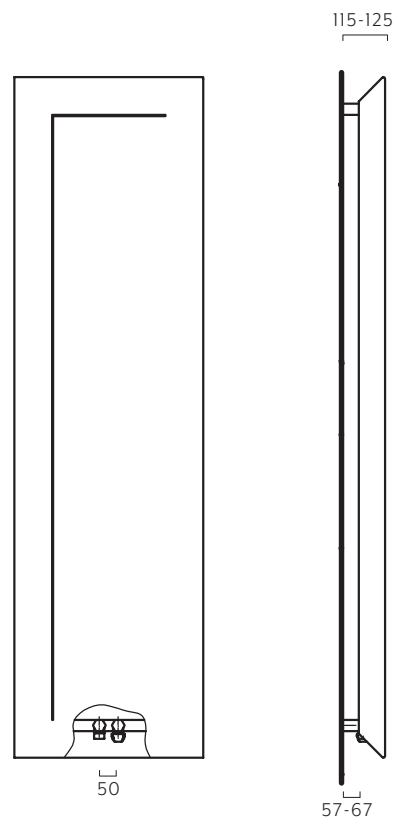

Red LED



Blue LED



Green LED



Remote Control



Supplied with a 12v transformer

# Athena shown on pages 58-59

Steel; Slimline radiator  
CE/UKCA approved & certified to BS EN442.

White RAL 9016 as standard, 188 RAL colours plus 30 Special Finishes  
Please call **01342 302250** for a RAL or Special Finish chart.

## Stock White RAL 9016: 48-72 Hours

Made to Order sizes & colours: Up to 7 weeks for white  
Up to 8 weeks for colours.



**SAVE £45** WHEN YOU BUY OUR **IDEAL TRV KIT** WITH ANY DESIGNER ORDER\*  
QUOTE **PROMOVI** AT TIME OF ORDER

Available in White or Chrome

Pipe centres left to right	Pipe centres from wall	Depth from wall
width - 70mm	45mm to 53mm	67mm to 75mm

## Stock options White RAL 9016 - Horizontal

Height (mm)	Width (mm)	Model	Watts Δt 50°C	Btu's Δt 50°C	White Ex VAT	White Inc VAT	Colours Ex VAT	Colours Inc VAT
DELIVERY TIMES					48-72 HOURS		UP TO 8 WEEKS	
410	1000	ATHEH4110	392	1338	<b>£626.00</b>	<b>£751.20</b>	£782.50	£939.00
	1200	ATHEH4112	474	1617	<b>£664.00</b>	<b>£796.80</b>	£830.00	£996.00
495	1000	ATHEH4910	460	1570	<b>£659.00</b>	<b>£790.80</b>	£823.75	£988.50
	1200	ATHEH4912	553	1887	<b>£700.00</b>	<b>£840.00</b>	£875.00	£1,050.00

67-75  
45-53

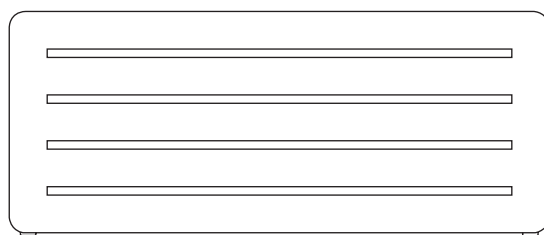

Made to order options - Horizontal

Height (mm)	Width (mm)	Model	Watts Δt 50°C	Btu's Δt 50°C	White Ex VAT	White Inc VAT	Colours Ex VAT	Colours Inc VAT
DELIVERY TIMES					UP TO 7 WEEKS		UP TO 8 WEEKS	
410	1500	ATHEH4115	570	1945	£718.00	£861.60	£897.50	£1,077.00
495	1500	ATHEH4915	694	2368	£761.00	£913.20	£951.25	£1,141.50

## Stock options White RAL 9016 - Vertical

Height (mm)	Width (mm)	Model	Watts Δt 50°C	Btu's Δt 50°C	White Ex VAT	White Inc VAT	Colours Ex VAT	Colours Inc VAT
DELIVERY TIMES					48-72 HOURS		UP TO 8 WEEKS	
1800	410	ATHEV1841	686	2341	<b>£688.00</b>	<b>£825.60</b>	£860.00	£1,032.00
	495	ATHEV1849	837	2856	<b>£717.00</b>	<b>£860.40</b>	£896.25	£1,075.50

67-75  
45-53

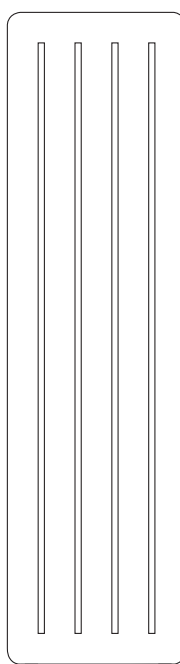

Made to order options - Vertical

Height (mm)	Width (mm)	Model	Watts Δt 50°C	Btu's Δt 50°C	White Ex VAT	White Inc VAT	Colours Ex VAT	Colours Inc VAT
DELIVERY TIMES					UP TO 7 WEEKS		UP TO 8 WEEKS	
1500	410	ATHEV1541	575	1962	£660.00	£792.00	£825.00	£990.00
	495	ATHEV1549	697	2378	£691.00	£829.20	£863.75	£1,036.50

\*Saving based on the value of individual items when bought separately. Order any of our selected valves & matching pipe covers at the same time as your radiator; PROMOVIW (white), PROMOVIC (chrome).

# Halo shown on page 62-63

High quality Italian design & manufacture.  
Steel; 87mm, 133mm, 155mm 180mm & 187mm fins  
CE/UKCA approved & certified to BS EN442.

Matt White RAL 9016 as standard, 188 RAL colours plus 2 Special Finishes; Metallic Silver & Matt Black. Please call **01342 302250** for a RAL chart.

Made to Order sizes & colours: Up to 7 weeks for white  
Up to 7 weeks for colours, 9 weeks for chrome.



**SAVE £45** WHEN YOU BUY OUR **IDEAL TRV KIT** WITH ANY DESIGNER ORDER\*  
QUOTE **PROMOVI** AT TIME OF ORDER

Available in White or Chrome

Halo Horizontal	Pipe centres left to right	Pipe centres from wall
Halo 130mm	width + valves	minimum of 65mm
Halo 190mm	width + valves	minimum of 90mm
Halo 250mm	width + valves	minimum of 120mm

## Made to order options - Horizontal White & Colours

Height (mm)	Width (mm)	Model	Watts Δt 50°C	BTU's Δt 50°C	Matt White Ex VAT	Matt White Inc VAT	Colour & Finishes Ex VAT	Colour & Finishes Inc VAT
DELIVERY TIMES			UP TO 7 WEEKS		UP TO 7 WEEKS			
130	1000	HALOI310	269	918	£949.00	£1,138.80	£1,138.80	£1,366.56
	1500	HALOI315	413	1409	£1,029.00	£1,234.80	£1,234.80	£1,481.76
	2000	HALOI320	557	1900	£1,107.00	£1,328.40	£1,328.40	£1,594.08
190	1000	HALOI910	401	1368	£1,156.00	£1,387.20	£1,387.20	£1,664.64
	1500	HALOI915	616	2102	£1,264.00	£1,516.80	£1,516.80	£1,820.16
	2000	HALOI920	831	2835	£1,399.00	£1,678.80	£1,678.80	£2,014.56
250	1000	HALO2510	993	3388	£1,177.00	£1,412.40	£1,412.40	£1,694.88
	1500	HALO2515	1490	5084	£1,492.00	£1,790.40	£1,790.40	£2,148.48
	2000	HALO2520	1969	6718	£1,949.00	£2,338.80	£2,338.80	£2,806.56

## Made to order options - Horizontal Chrome

Height (mm)	Width (mm)	Model	Watts Δt 50°C	BTU's Δt 50°C	Chrome Ex VAT	Chrome Inc VAT
DELIVERY TIMES			UP TO 9 WEEKS			
190	1000	HALO1910C	353	1204	£1,276.00	£1,531.20
	1500	HALO1915C	542	1849	£1,428.00	£1,713.60
	2000	HALO1920C	731	2494	£1,756.00	£2,107.20
250	1000	HALO2510C	874	2982	£1,422.00	£1,706.40
	1500	HALO2515C	1311	4473	£2,130.00	£2,556.00
	2000	HALO2520C	1733	5913	£2,842.00	£3,410.40

## Made to order options - Horizontal Electric

Height (mm)	Width (mm)	Model	Watts Δt 50°C	Matt White Ex VAT	Matt White Inc VAT	Colour & Finishes Ex VAT	Colour & Finishes Inc VAT	Chrome Ex VAT	Chrome Inc VAT
DELIVERY TIMES			UP TO 7 WEEKS		UP TO 7 WEEKS		UP TO 9 WEEKS		
180	1015	HALOE1810	500	£1,397.00	£1,676.40	£1,676.40	£2,011.68	£1,643.00	£1,971.60
	1515	HALOE1815	750	£1,600.00	£1,920.00	£1,920.00	£2,304.00	£2,042.00	£2,450.40
	2015	HALOE1820	1000	£1,772.00	£2,126.40	£2,126.40	£2,551.68	£2,581.00	£3,097.20

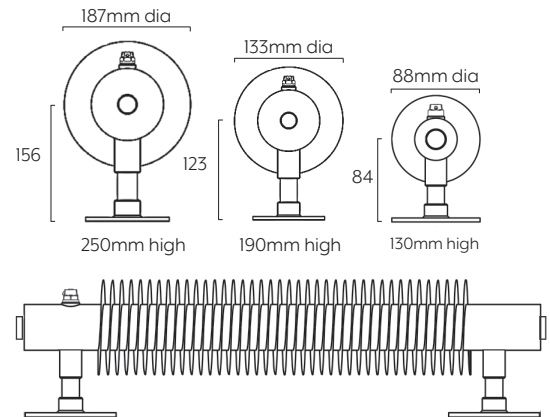

Halo Vertical	Pipe centres left to right	Pipe centres from wall	Depth from wall
Halo 155mm	60mm	148mm	225mm

## Made to order options - Vertical White & Colours

Height (mm)	Width (mm)	Model	Watts Δt 50°C	BTU's Δt 50°C	Matt White Ex VAT	Matt White Inc VAT	Colour & Finishes Ex VAT	Colour & Finishes Inc VAT
DELIVERY TIMES			UP TO 7 WEEKS		UP TO 7 WEEKS			
1500	155	HALOV1515	865	2951	£1,646.00	£1,975.20	£1,975.20	£2,370.24
1800	155	HALOV1815	1040	3548	£1,799.00	£2,158.80	£2,158.80	£2,590.56
2000	155	HALOV2015	1153	3934	£1,863.00	£2,235.60	£2,235.60	£2,682.72

## Made to order options - Vertical Chrome

Height (mm)	Width (mm)	Model	Watts Δt 50°C	BTU's Δt 50°C	Chrome Ex VAT	Chrome Inc VAT
DELIVERY TIMES			UP TO 9 WEEKS			
1500	155	HALOV1515C	761	2597	£2,219.00	£2,662.80
1800	155	HALOV1815C	915	3122	£2,694.00	£3,232.80
2000	155	HALOV2015C	1015	3463	£2,996.00	£3,595.20

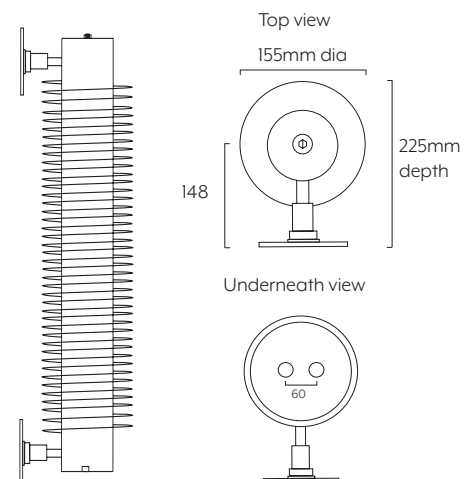

\*Saving based on the value of individual items when bought separately.  
Order any of our selected valves & matching pipe covers at the same time as your radiator; PROMOVIW (white), PROMOVI (chrome).

# Relax Horizontal shown on page 60

High quality Italian design & manufacture.

Steel; Slimline round tube on tube radiator cloaked in a steel cover  
CE/UKCA approved & certified to BS EN442.

White RAL 9016 as standard, 188 RAL colours plus 30 Special Finishes

Please call **01342 302250** for a RAL or Special Finish chart.

## Stock White RAL 9016: 48-72 Hours

Made to Order sizes & colours: Up to 5 weeks.



**SAVE £45** WHEN YOU BUY OUR **IDEAL TRV KIT** WITH ANY DESIGNER ORDER\*  
QUOTE **PROMOVI** AT TIME OF ORDER

Available in White or Chrome

Relax horizontal	Pipe centres left to right	Pipe centres from wall	Depth from wall
Single horizontal	width - 109mm	55mm	88mm

## Stock options White RAL 9016 - Single Horizontal

Height (mm)	Width (mm)	Model	Watts Δt 50°C	Btu's Δt 50°C	White Ex VAT	White Inc VAT	Colours Ex VAT	Colours Inc VAT
DELIVERY TIMES					48-72 HOURS		UP TO 5 WEEKS	
478	1197	RELASH4711	665	2269	£806.00	£967.20	£1,007.50	£1,209.00
578	1197	RELASH5711	824	2811	£831.00	£997.20	£1,038.75	£1,246.50

Made to order options - Single Horizontal

Height (mm)	Width (mm)	Model	Watts Δt 50°C	Btu's Δt 50°C	White Ex VAT	White Inc VAT	Colours Ex VAT	Colours Inc VAT
DELIVERY TIMES					UP TO 5 WEEKS		UP TO 5 WEEKS	
478	1401	RELASH4714	783	2672	£892.00	£1,070.40	£1,115.00	£1,338.00
	1809	RELASH4718	1019	3477	£1,156.00	£1,387.20	£1,445.00	£1,734.00
	2013	RELASH4720	1137	3879	£1,274.00	£1,528.80	£1,592.50	£1,911.00
578	1401	RELASH5714	970	3310	£916.00	£1,099.20	£1,145.00	£1,374.00
	1809	RELASH5718	1262	4306	£1,191.00	£1,429.20	£1,488.75	£1,786.50
	2013	RELASH5720	1408	4804	£1,311.00	£1,573.20	£1,638.75	£1,966.50

Relax horizontal	Pipe centres left to right	Pipe centres from wall	Depth from wall
Double horizontal	width - 109mm	79mm to 89mm	112mm to 122mm

## Stock options White RAL 9016 - Double Horizontal

Height (mm)	Width (mm)	Model	Watts Δt 50°C	Btu's Δt 50°C	White Ex VAT	White Inc VAT	Colours Ex VAT	Colours Inc VAT
DELIVERY TIMES					48-72 HOURS		UP TO 5 WEEKS	
478	1197	RELADH4711	1045	3566	£981.00	£1,177.20	£1,226.25	£1,471.50
578	1197	RELADH5711	1294	4415	£1,067.00	£1,280.40	£1,333.75	£1,600.50

Made to order options - Double Horizontal

Height (mm)	Width (mm)	Model	Watts Δt 50°C	Btu's Δt 50°C	White Ex VAT	White Inc VAT	Colours Ex VAT	Colours Inc VAT
DELIVERY TIMES					UP TO 5 WEEKS		UP TO 5 WEEKS	
478	1401	RELADH4714	1231	4200	£1,061.00	£1,273.20	£1,326.25	£1,591.50
	1809	RELADH4718	1602	5466	£1,379.00	£1,654.80	£1,723.75	£2,068.50
	2013	RELADH4720	1787	6097	£1,517.00	£1,820.40	£1,896.25	£2,275.50
578	1401	RELADH5714	1524	5200	£1,165.00	£1,398.00	£1,456.25	£1,747.50
	1809	RELADH5718	1983	6766	£1,514.00	£1,816.80	£1,892.50	£2,271.00
	2013	RELADH5720	2213	7551	£1,667.00	£2,000.40	£2,083.75	£2,500.50

Single

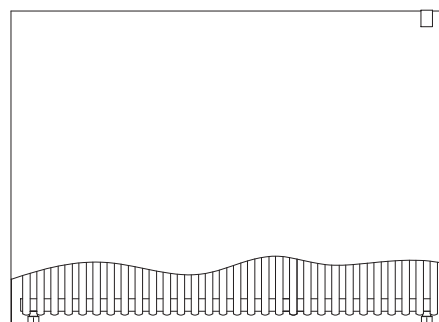

Double

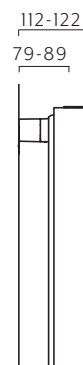

\*Saving based on the value of individual items when bought separately. Order any of our selected valves & matching pipe covers at the same time as your radiator; PROMOVIW (white), PROMOVIC (chrome).

# Relax Vertical shown on page 61

High quality Italian design & manufacture.

Steel; Slimline round tube on tube radiator cloaked in a steel cover  
CE/UKCA approved & certified to BS EN442.



White RAL 9016 as standard, 188 RAL colours plus 30 Special Finishes  
Please call **01342 302250** for a RAL or Special Finish chart.

## Stock White RAL 9016: 48-72 Hours

Made to Order sizes & colours: Up to 5 weeks for white & colours  
Up to 8 weeks for Polished Stainless Steel.



**SAVE £45** WHEN YOU BUY OUR **IDEAL TRV KIT** WITH ANY DESIGNER ORDER\*  
QUOTE **PROMOVI** AT TIME OF ORDER

Available in White or Chrome

Relax vertical	Pipe centres left to right	Pipe centres from wall	Depth from wall
Single vertical	width - 109mm	55mm	88mm

## Stock options White RAL 9016 - Single Vertical

Height (mm)	Width (mm)	Model	Watts Δt 50°C	Btu's Δt 50°C	White Ex VAT	White Inc VAT	Colours Ex VAT	Colours Inc VAT
DELIVERY TIMES					48-72 HOURS		UP TO 5 WEEKS	
1853	517	RELASV1851	1178	4019	<b>£1,008.00</b>	<b>£1,209.60</b>	£1,260.00	£1,512.00
	653	RELASV1865	1519	5183	<b>£1,099.00</b>	<b>£1,318.80</b>	£1,373.75	£1,648.50

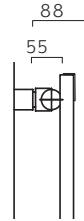

## Made to order options - Inox Single Vertical

Height (mm)	Width (mm)	Model	Watts Δt 50°C	Btu's Δt 50°C	Polished Stainless Steel Ex VAT	Polished Stainless Steel Inc VAT
DELIVERY TIMES			UP TO 8 WEEKS			
1553	381	REINSV1538	489	1668	£2,048.00	£2,457.60
	517	REINSV1551	689	2351	£2,183.00	£2,619.60
	653	REINSV1565	888	3030	£2,277.00	£2,732.40
1853	381	REINSV1838	586	1999	£2,423.00	£2,907.60
	517	REINSV1851	825	2815	£2,656.00	£3,187.20
	653	REINSV1865	1063	3627	£2,842.00	£3,410.40
2053	381	REINSV2038	650	2218	£2,558.00	£3,069.60
	517	REINSV2051	915	3122	£2,842.00	£3,410.40
	653	REINSV2065	1180	4026	£3,031.00	£3,637.20

## Made to order options - Single Vertical

Height (mm)	Width (mm)	Model	Watts Δt 50°C	Btu's Δt 50°C	White Ex VAT	White Inc VAT	Colours Ex VAT	Colours Inc VAT
DELIVERY TIMES			UP TO 5 WEEKS		UP TO 5 WEEKS			
1553	381	RELASV1538	699	2385	£737.00	£884.40	£921.25	£1,105.50
	517	RELASV1551	984	3357	£839.00	£1,006.80	£1,048.75	£1,258.50
	653	RELASV1565	1269	4330	£922.00	£1,106.40	£1,152.50	£1,383.00
1853	381	RELASV1838	837	2856	£802.00	£962.40	£1,002.50	£1,203.00

Relax vertical	Pipe centres left to right	Pipe centres from wall	Depth from wall
Double vertical	width - 109mm	79mm - 89mm	112mm - 122mm

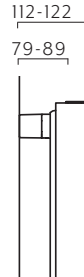

## Stock options White RAL 9016 - Double Vertical

Height (mm)	Width (mm)	Model	Watts Δt 50°C	Btu's Δt 50°C	White Ex VAT	White Inc VAT	Colours Ex VAT	Colours Inc VAT
DELIVERY TIMES			48-72 HOURS		UP TO 5 WEEKS			
1853	517	RELADV1851	1477	5040	<b>£1,268.00</b>	<b>£1,521.60</b>	£1,585.00	£1,902.00
	653	RELADV1865	1817	6200	<b>£1,555.00</b>	<b>£1,866.00</b>	£1,943.75	£2,332.50

## Made to order options - Double Vertical

Height (mm)	Width (mm)	Model	Watts Δt 50°C	Btu's Δt 50°C	White Ex VAT	White Inc VAT	Colours Ex VAT	Colours Inc VAT
DELIVERY TIMES			UP TO 5 WEEKS		UP TO 5 WEEKS			
1553	381	RELADV1538	1017	3470	£990.00	£1,188.00	£1,237.50	£1,485.00
	517	RELADV1551	1431	4883	£1,086.00	£1,303.20	£1,357.50	£1,629.00
	653	RELADV1565	1591	5428	£1,177.00	£1,412.40	£1,471.25	£1,765.50
1853	381	RELADV1838	1050	3583	£1,061.00	£1,273.20	£1,326.25	£1,591.50

## Made to order options - Inox Double Vertical

Height (mm)	Width (mm)	Model	Watts Δt 50°C	Btu's Δt 50°C	Polished Stainless Steel Ex VAT	Polished Stainless Steel Inc VAT
DELIVERY TIMES			UP TO 8 WEEKS			
1553	381	REINDV1538	712	2429	£2,830.00	£3,396.00
	517	REINDV1551	1002	3419	£2,928.00	£3,513.60
	653	REINDV1565	1114	3801	£3,123.00	£3,747.60
1853	381	REINDV1838	735	2508	£3,322.00	£3,986.40
	517	REINDV1851	1034	3528	£3,616.00	£4,339.20
	653	REINDV1865	1272	4340	£3,807.00	£4,568.40
2053	381	REINDV2038	778	2655	£3,517.00	£4,220.40
	517	REINDV2051	1095	3736	£3,867.00	£4,640.40
	653	REINDV2065	1397	4767	£4,104.00	£4,924.80

\*Saving based on the value of individual items when bought separately. Order any of our selected valves & matching pipe covers at the same time as your radiator; PROMOVIV (white), PROMOVIC (chrome).

# Sectional Stocked Aluminium

All our sectional aluminium is held in stock in the UK. White product can be delivered in 48-72 hours and coloured orders will be finished and delivered in up to 3 weeks. Our most popular sizes are listed in the price tables, for other sizes use our online radiator builder or follow the instructions below to specify your radiator.

## Choose your radiator using our online radiator builder

Once you know your outputs use our **online radiator builder** to select the best solution for your room. It will take you through the process quickly and easily and allows you to save your ideas to your own Wish List. Go to our **NEW** website [theradiatorcompany.co.uk](http://theradiatorcompany.co.uk)

It is vital to know the correct heat output you need to keep your room warm, use our online Heat Output Calculator to get a guide to your requirements which you can then check with your installer.

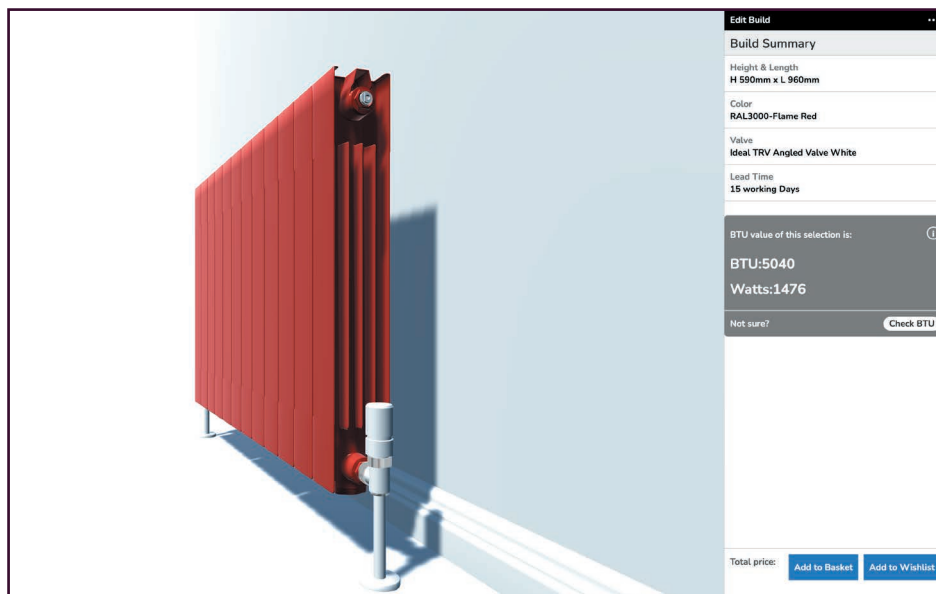

Once you know your outputs you can also use the brochure to specify your radiator by following these steps (or call our Customer Services team on 01342 302250 who will help you size your radiator)

Note the space you have in mind for the radiator(s) you need; vertical or horizontal, length, height & depth

- Select a column option and height that fits your space; Calculate the number of Sections you need by dividing the required BTU (Watt) output with the output per section; e.g  $4811 \text{ BTUs} \div 420 = 11.45$ , (we always suggest rounding up, as it is better to have too much output, than too little) therefore 12 sections based on Vip 590
- If using that section size does work in the space available, try a different height or alternative aluminium profile
- Once you have calculated the best number and size of section, select your colour. Our Aluminium Radiators are available in a selection of the top 23 most popular colours from the RAL range and 30 Special Finishes (shown on pages 65 & 197). Please specify your RAL colour or special finish at time of order. White RAL 9010 is our standard for the Vip, Oscar, Vox and Mix
- Work out the price of your radiator by multiplying the section price by the total number of sections e.g Vip 590 high, 12 sections in RAL 3000 - Flame Red =  $\pounds 76.72 \times 12 = \pounds 920.64$  (inc VAT)
- Place your order by using the Sectional Model Code x No. of Sections needed and noting the colour number and name selected; e.g VIP59 X12 in RAL 3000
- If you have chosen a colour make sure you list the colour number and name

All prices and outputs are given per section in the tables on pages 176-185. Price per section includes plugs, bushes and diverter.

End Panels for the Vip & Oscar must be specified at time of order, please see page 177 for more information.

## Aluminium Colours

All our Sectional Aluminium radiators are available in a selection of the top 23 most popular colours from the RAL range as well as 30 exclusive special finishes. These radiators provide both the efficiencies of aluminium and a stunning finish.

Available in up to 3 weeks. Please call **01342 302250** for a RAL or Special Finish chart

For orders of more than 10 radiators in colour or special finishes please allow an extra 10 working days for delivery.



### New Colour Coordination Service

Available for all sectional aluminium, see product pages 6-7 for full details including process & lead times.





# Aluminium Accessories

## Hanging Bars & Pegs

These towel bars and pegs are designed to fit all of our sectional aluminium ranges except the Ottimo. Ideal for providing additional hanging space to air towels or hang bathrobes. **Available from stock in 48-72 hours.**

Description/ Suitable for	Model	White Ex VAT	White Inc VAT	Chrome Ex VAT	Chrome Inc VAT
DELIVERY TIMES		48-72 HOURS			
Peg / Vip, Mix, Vox, Oscar	AAHPEG01	£29.00	£34.80	£35.00	£42.00
Bar 480mm / Vip, Mix, Vox, Oscar	AAHBAR01	£84.00	£100.80	£103.00	£123.60
Bar 320mm / Vip, Mix, Vox, Oscar	AAHBAR02	£84.00	£100.80	£103.00	£123.60

320mm Towel Bars need a minimum of 6 sections to fit  
480mm Towel Bars need a minimum of 8 sections to fit



A nominal £5 charge for postage and packing will be applied to any orders under £50 in value

## Complete the look with End Panels

### Vip End Panels stock options RAL 9010

Height (mm)	Model	White Ex VAT	White Inc VAT	RAL Colours Ex VAT	RAL Colours Inc VAT	Special Finishes Ex VAT	Special Finishes Inc VAT
DELIVERY TIMES		48-72 HOURS		UP TO 3 WEEKS		UP TO 3 WEEKS	
440	VIPEP44	£67.00	£80.40	£98.49	£118.19	£105.86	£127.03
590	VIPEP59	£76.00	£91.20	£111.72	£134.06	£120.08	£144.10
690	VIPEP69	£82.00	£98.40	£120.54	£144.65	£129.56	£155.47
790	VIPEP79	£84.00	£100.80	£123.48	£148.18	£132.72	£159.26

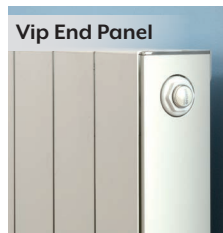

Please specify at time of order if you would like End Panels with your Vip radiator

### Oscar End Panels stock options RAL 9010

Height (mm)	Model	White Ex VAT	White Inc VAT	RAL Colours Ex VAT	RAL Colours Inc VAT	Special Finishes Ex VAT	Special Finishes Inc VAT
DELIVERY TIMES		48-72 HOURS		UP TO 3 WEEKS		UP TO 3 WEEKS	
1046	OSCAEP10	£106.00	£127.20	£154.76	£185.71	£167.48	£200.98
1246	OSCAEP12	£109.00	£130.80	£159.14	£190.97	£172.22	£206.66
1446	OSCAEP14	£118.00	£141.60	£172.28	£206.74	£186.44	£223.73
1646	OSCAEP16	£136.00	£163.20	£198.56	£238.27	£214.88	£257.86
1846	OSCAEP18	£140.00	£168.00	£204.40	£245.28	£221.20	£265.44
2046	OSCAEP20	£146.00	£175.20	£213.16	£255.79	£230.68	£276.82

Please specify at time of order if you would like End Panels with your Oscar radiator

## Joining Key

Joining Keys are available on a sale or return basis. Joining Keys must be specified at time of order. For assistance please contact our Customer Service team on **01342 302250**, they will also arrange a courier to collect it from you when you are ready.

Description/ Suitable for	Model	Price Ex VAT	Price Ex VAT
DELIVERY TIMES		48-72 HOURS	
Joining Key 1" x 300mm/600mm/900mm	PPASM	£506.00	£607.20





High quality Italian design & manufacture.  
Sectional Aluminium. CE/UKCA approved & certified to BS EN442.



White RAL 9010 as standard, 23 RAL colours plus 30 Special Finishes  
Please call **01342 302250** for a RAL or Special Finish chart  
Colour Coordination Service available, see pages 6-7 for full details.

### Stock White RAL 9010: 48-72 Hours

Colours & Finishes: Up to 3 weeks (please allow up to 5 weeks for orders of more than 10 radiators in colours or special finishes).

Choose from our assembled stock options or build your own size by individual section, visit [theradiatorcompany.co.uk](http://theradiatorcompany.co.uk) to use our radiator builder.



**SAVE £45** WHEN YOU BUY OUR **IDEAL TRV KIT** WITH ANY DESIGNER ORDER\*  
QUOTE **PROMOVI** AT TIME OF ORDER

Available in White or Chrome



### Assembled stock options RAL 9010

440mm High

Height (mm)	Width (mm)	Sections	Model	Watts Δt 50°C	Btu's Δt 50°C	White Ex VAT	White Inc VAT	RAL Colours Ex VAT	RAL Colours Inc VAT	Special Finishes Ex VAT	Special Finishes Inc VAT
DELIVERY TIMES						48-72 HOURS		UP TO 3 WEEKS		UP TO 3 WEEKS	
440	420	5	VIPS44X5	470	1604	£222.70	£267.24	£314.00	£376.80	£336.30	£403.56
	500	6	VIPS44X6	564	1924	£267.24	£320.69	£376.80	£452.16	£403.56	£484.27
	580	7	VIPS44X7	658	2245	£311.78	£374.14	£439.60	£527.52	£470.82	£564.98
	660	8	VIPS44X8	752	2566	£356.32	£427.58	£502.40	£602.88	£538.08	£645.70
	740	9	VIPS44X9	846	2887	£400.86	£481.03	£565.20	£678.24	£605.34	£726.41
	820	10	VIPS44X10	940	3207	£445.40	£534.48	£628.00	£753.60	£672.60	£807.12
	900	11	VIPS44X11	1034	3528	£489.94	£587.93	£690.80	£828.96	£739.86	£887.83
	980	12	VIPS44X12	1128	3849	£534.48	£641.38	£753.60	£904.32	£807.12	£968.54
	1060	13	VIPS44X13	1222	4169	£579.02	£694.82	£816.40	£979.68	£874.38	£1,049.26
	1140	14	VIPS44X14	1316	4490	£623.56	£748.27	£879.20	£1,055.04	£941.64	£1,129.97
	1220	15	VIPS44X15	1410	4811	£668.10	£801.72	£942.00	£1,130.40	£1,008.90	£1,210.68
	1300	16	VIPS44X16	1504	5132	£712.64	£855.17	£1,004.80	£1,205.76	£1,076.16	£1,291.39
	1380	17	VIPS44X17	1598	5452	£757.18	£908.62	£1,067.60	£1,281.12	£1,143.42	£1,372.10
	1460	18	VIPS44X18	1692	5773	£801.72	£962.06	£1,130.40	£1,356.48	£1,210.68	£1,452.82
1540	19	VIPS44X19	1786	6094	£846.26	£1,015.51	£1,193.20	£1,431.84	£1,277.94	£1,533.53	
1620	20	VIPS44X20	1880	6415	£890.80	£1,068.96	£1,256.00	£1,507.20	£1,345.20	£1,614.24	

23 RAL colours are shown on page 197

590mm High

Height (mm)	Width (mm)	Sections	Model	Watts Δt 50°C	Btu's Δt 50°C	White Ex VAT	White Inc VAT	RAL Colours Ex VAT	RAL Colours Inc VAT	Special Finishes Ex VAT	Special Finishes Inc VAT
DELIVERY TIMES						48-72 HOURS		UP TO 3 WEEKS		UP TO 3 WEEKS	
590	420	5	VIPS59X5	615	2098	£226.70	£272.04	£319.65	£383.58	£342.30	£410.76
	500	6	VIPS59X6	738	2518	£272.04	£326.45	£383.58	£460.30	£410.76	£492.91
	580	7	VIPS59X7	861	2938	£317.38	£380.86	£447.51	£537.01	£479.22	£575.06
	660	8	VIPS59X8	984	3357	£362.72	£435.26	£511.44	£613.73	£547.68	£657.22
	740	9	VIPS59X9	1107	3777	£408.06	£489.67	£575.37	£690.44	£616.14	£739.37
	820	10	VIPS59X10	1230	4197	£453.40	£544.08	£639.30	£767.16	£684.60	£821.52
	900	11	VIPS59X11	1353	4616	£498.74	£598.49	£703.23	£843.88	£753.06	£903.67
	980	12	VIPS59X12	1476	5036	£544.08	£652.90	£767.16	£920.59	£821.52	£985.82
	1060	13	VIPS59X13	1599	5456	£589.42	£707.30	£831.09	£997.31	£889.98	£1,067.98
	1140	14	VIPS59X14	1722	5875	£634.76	£761.71	£895.02	£1,074.02	£958.44	£1,150.13
	1220	15	VIPS59X15	1845	6295	£680.10	£816.12	£958.95	£1,150.74	£1,026.90	£1,232.28
	1300	16	VIPS59X16	1968	6715	£725.44	£870.53	£1,022.88	£1,227.46	£1,095.36	£1,314.43
	1380	17	VIPS59X17	2091	7134	£770.78	£924.94	£1,086.81	£1,304.17	£1,163.82	£1,396.58
	1460	18	VIPS59X18	2214	7554	£816.12	£979.34	£1,150.74	£1,380.89	£1,232.28	£1,478.74
1540	19	VIPS59X19	2337	7974	£861.46	£1,033.75	£1,214.67	£1,457.60	£1,300.74	£1,560.89	
1620	20	VIPS59X20	2460	8394	£906.80	£1,088.16	£1,278.60	£1,534.32	£1,369.20	£1,643.04	

23 RAL colours are shown on page 197

Widths include measurement for bushes

Quoted prices include plugs, bushes, air vent and wall brackets but excludes end panels.

Optional end panels available, please specify at time of order, see page 177 for prices.

Pipe centres left to right	Pipe centres from wall	Depth from wall
width + valves	67mm to 71mm	114mm to 118mm

VIP69X5 - 690mm x 420mm

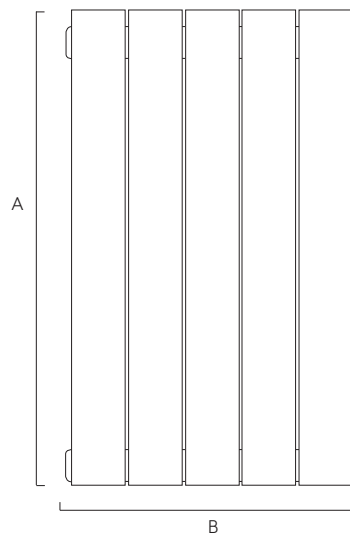

Optional end panels available for the Vip range, see page 177 for more information and pricing.

Please specify at time of order.

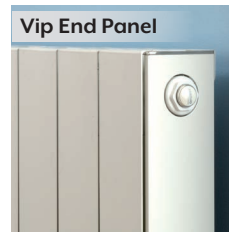

\*Saving based on the value of individual items when bought separately. Order any of our selected valves & matching pipe covers at the same time as your radiator; PROMOVIW (white), PROMOVIC (chrome).

## Assembled stock option RAL 9010

690mm High

Height (mm)	Width (mm)	Sections	Model	Watts Δt 50°C	Btu's Δt 50°C	White Ex VAT	White Inc VAT	RAL Colours Ex VAT	RAL Colours Inc VAT	Special Finishes Ex VAT	Special Finishes Inc VAT
DELIVERY TIMES						48-72 HOURS		UP TO 3 WEEKS		UP TO 3 WEEKS	
690	420	5	VIPS69X5	710	2423	£234.90	£281.88	£331.20	£397.44	£354.70	£425.64
	500	6	VIPS69X6	852	2907	£281.88	£338.26	£397.44	£476.93	£425.64	£510.77
	580	7	VIPS69X7	994	3392	£328.86	£394.63	£463.68	£556.42	£496.58	£595.90
	660	8	VIPS69X8	1136	3876	£375.84	£451.01	£529.92	£635.90	£567.52	£681.02
	740	9	VIPS69X9	1278	4361	£422.82	£507.38	£596.16	£715.39	£638.46	£766.15
	820	10	VIPS69X10	1420	4845	£469.80	£563.76	£662.40	£794.88	£709.40	£851.28
	900	11	VIPS69X11	1562	5330	£516.78	£620.14	£728.64	£874.37	£780.34	£936.41
	980	12	VIPS69X12	1704	5814	£563.76	£676.51	£794.88	£953.86	£851.28	£1,021.54
	1060	13	VIPS69X13	1846	6299	£610.74	£732.89	£861.12	£1,033.34	£922.22	£1,106.66
	1140	14	VIPS69X14	1988	6783	£657.72	£789.26	£927.36	£1,112.83	£993.16	£1,191.79
	1220	15	VIPS69X15	2130	7268	£704.70	£845.64	£993.60	£1,192.32	£1,064.10	£1,276.92
	1300	16	VIPS69X16	2272	7752	£751.68	£902.02	£1,059.84	£1,271.81	£1,135.04	£1,362.05
	1380	17	VIPS69X17	2414	8237	£798.66	£958.39	£1,126.08	£1,351.30	£1,205.98	£1,447.18
	1460	18	VIPS69X18	2556	8721	£845.64	£1,014.77	£1,192.32	£1,430.78	£1,276.92	£1,532.30
	1540	19	VIPS69X19	2698	9206	£892.62	£1,071.14	£1,258.56	£1,510.27	£1,347.86	£1,617.43
	1620	20	VIPS69X20	2840	9690	£939.60	£1,127.52	£1,324.80	£1,589.76	£1,418.80	£1,702.56

23 RAL colours are shown on page 197

790mm High

Height (mm)	Width (mm)	Sections	Model	Watts Δt 50°C	Btu's Δt 50°C	White Ex VAT	White Inc VAT	RAL Colours Ex VAT	RAL Colours Inc VAT	Special Finishes Ex VAT	Special Finishes Inc VAT
DELIVERY TIMES						48-72 HOURS		UP TO 3 WEEKS		UP TO 3 WEEKS	
790	420	5	VIPS79X5	805	2747	£266.95	£320.34	£376.40	£451.68	£403.10	£483.72
	500	6	VIPS79X6	966	3296	£320.34	£384.41	£451.68	£542.02	£483.72	£580.46
	580	7	VIPS79X7	1127	3845	£373.73	£448.48	£526.96	£632.35	£564.34	£677.21
	660	8	VIPS79X8	1288	4395	£427.12	£512.54	£602.24	£722.69	£644.96	£773.95
	740	9	VIPS79X9	1449	4944	£480.51	£576.61	£677.52	£813.02	£725.58	£870.70
	820	10	VIPS79X10	1610	5493	£533.90	£640.68	£752.80	£903.36	£806.20	£967.44
	900	11	VIPS79X11	1771	6043	£587.29	£704.75	£828.08	£993.70	£886.82	£1,064.18
	980	12	VIPS79X12	1932	6592	£640.68	£768.82	£903.36	£1,084.03	£967.44	£1,160.93
	1060	13	VIPS79X13	2093	7141	£694.07	£832.88	£978.64	£1,174.37	£1,048.06	£1,257.67
	1140	14	VIPS79X14	2254	7691	£747.46	£896.95	£1,053.92	£1,264.70	£1,128.68	£1,354.42
	1220	15	VIPS79X15	2415	8240	£800.85	£961.02	£1,129.20	£1,355.04	£1,209.30	£1,451.16
	1300	16	VIPS79X16	2576	8789	£854.24	£1,025.09	£1,204.48	£1,445.38	£1,289.92	£1,547.90
	1380	17	VIPS79X17	2737	9339	£907.63	£1,089.16	£1,279.76	£1,535.71	£1,370.54	£1,644.65
	1460	18	VIPS79X18	2898	9888	£961.02	£1,153.22	£1,355.04	£1,626.05	£1,451.16	£1,741.39
	1540	19	VIPS79X19	3059	10437	£1,014.41	£1,217.29	£1,430.32	£1,716.38	£1,531.78	£1,838.14
	1620	20	VIPS79X20	3220	10987	£1,067.80	£1,281.36	£1,505.60	£1,806.72	£1,612.40	£1,934.88

23 RAL colours are shown on page 197

## Stock options by section RAL 9010

Outputs & price given per section, see page 176 for help on sizing your radiator or visit [theradiatorcompany.co.uk](http://theradiatorcompany.co.uk) where you will find our radiator builder.

Height (mm)	Width (mm)	Model	Watts Δt 50°C	Btu's Δt 50°C	White Ex VAT	White Inc VAT	RAL Colours Ex VAT	RAL Colours Inc VAT	Special Finishes Ex VAT	Special Finishes Inc VAT	
DELIVERY TIMES						48-72 HOURS		UP TO 3 WEEKS			
440	80	VIP44	94	321	£44.54	£53.45	£62.80	£75.36	£67.26	£80.71	
590		VIP59	123	420	£45.34	£54.41	£63.93	£76.72	£68.46	£82.15	
690		VIP69	142	485	£46.98	£56.38	£66.24	£79.49	£70.94	£85.13	
790		VIP79	161	549	£53.39	£64.07	£75.28	£90.34	£80.62	£96.74	

23 RAL colours are shown on page 197

Pipe centres left to right	Pipe centres from wall	Depth from wall
no. of sections x 80mm + 20mm bushes + valves	67mm-71mm	114mm-118mm

Note: Supplied pre-assembled in up to 20 sections (1600mm), wider radiators must be joined on site.

Widths include measurement for bushes

Quoted prices include plugs, bushes, air vent and wall brackets but excludes end panels.

Optional end panels available, please specify at time of order, see page 177 for prices.

Pipe centres left to right	Pipe centres from wall	Depth from wall
width + valves	67mm-71mm	114mm-118mm

VIP69X5 - 690mm x 420mm

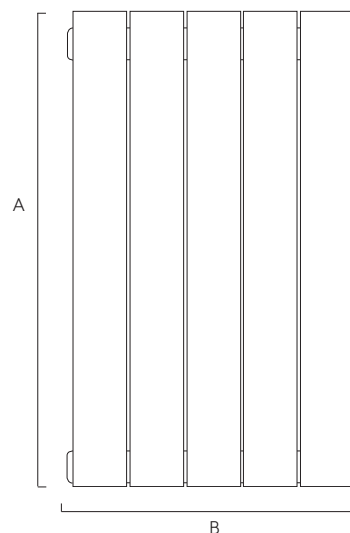

Optional end panels available for the Vip range, see page 177 for more information and pricing

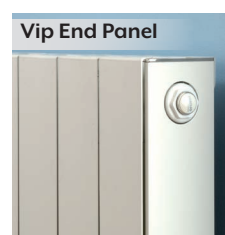



High quality Italian design & manufacture.  
Sectional Aluminium. CE/UKCA approved & certified to BS EN442.



White RAL 9010 as standard, 23 RAL colours plus 30 Special Finishes  
Please call **01342 302250** for a RAL or Special Finish chart  
Colour Coordination Service available, see pages 6-7 for full details.

### Stock White RAL 9010: 48-72 Hours

Colours & Finishes: Up to 3 weeks (please allow up to 5 weeks for orders of more than 10 radiators in colours or special finishes).

Choose from our assembled stock options or build your own size by individual section, visit [theradiatorcompany.co.uk](http://theradiatorcompany.co.uk) to use our radiator builder.



**SAVE £45** WHEN YOU BUY OUR IDEAL TRV KIT WITH ANY DESIGNER ORDER\*  
QUOTE PROMOVI AT TIME OF ORDER

Available in White or Chrome



### Assembled stock options RAL 9010

1046mm High

Height (mm)	Width (mm)	Sections	Model	Watts Δt 50°C	Btu's Δt 50°C	White Ex VAT	White Inc VAT	DELIVERY TIMES			
								48-72 HOURS	UP TO 3 WEEKS		UP TO 3 WEEKS
1046	260	3	OSCASI0X3	570	1945	<b>£227.40</b>	<b>£272.88</b>	£320.64	£384.77	£343.38	£412.06
	340	4	OSCASI0X4	760	2593	<b>£303.20</b>	<b>£363.84</b>	£427.52	£513.02	£457.84	£549.41
	420	5	OSCASI0X5	950	3241	<b>£379.00</b>	<b>£454.80</b>	£534.40	£641.28	£572.30	£686.76
	500	6	OSCASI0X6	1140	3890	<b>£454.80</b>	<b>£545.76</b>	£641.28	£769.54	£686.76	£824.11
	580	7	OSCASI0X7	1330	4538	<b>£530.60</b>	<b>£636.72</b>	£748.16	£897.79	£801.22	£961.46
	660	8	OSCASI0X8	1520	5186	<b>£606.40</b>	<b>£727.68</b>	£855.04	£1,026.05	£915.68	£1,098.82
	740	9	OSCASI0X9	1710	5835	<b>£682.20</b>	<b>£818.64</b>	£961.92	£1,154.30	£1,030.14	£1,236.17
	820	10	OSCASI0X10	1900	6483	<b>£758.00</b>	<b>£909.60</b>	£1,068.80	£1,282.56	£1,144.60	£1,373.52

23 RAL colours are shown on page 197

1246mm High

Height (mm)	Width (mm)	Sections	Model	Watts Δt 50°C	Btu's Δt 50°C	White Ex VAT	White Inc VAT	DELIVERY TIMES			
								48-72 HOURS	UP TO 3 WEEKS		UP TO 3 WEEKS
1246	260	3	OSCASI2X3	654	2231	<b>£296.13</b>	<b>£355.36</b>	£417.54	£501.05	£447.15	£536.58
	340	4	OSCASI2X4	872	2975	<b>£394.84</b>	<b>£473.81</b>	£556.72	£668.06	£596.20	£715.44
	420	5	OSCASI2X5	1090	3719	<b>£493.55</b>	<b>£592.26</b>	£695.90	£835.08	£745.25	£894.30
	500	6	OSCASI2X6	1308	4463	<b>£592.26</b>	<b>£710.71</b>	£835.08	£1,002.10	£894.30	£1,073.16
	580	7	OSCASI2X7	1526	5207	<b>£690.97</b>	<b>£829.16</b>	£974.26	£1,169.11	£1,043.35	£1,252.02
	660	8	OSCASI2X8	1744	5951	<b>£789.68</b>	<b>£947.62</b>	£1,113.44	£1,336.13	£1,192.40	£1,430.88
	740	9	OSCASI2X9	1962	6694	<b>£888.39</b>	<b>£1,066.07</b>	£1,252.62	£1,503.14	£1,341.45	£1,609.74
	820	10	OSCASI2X10	2180	7438	<b>£987.10</b>	<b>£1,184.52</b>	£1,391.80	£1,670.16	£1,490.50	£1,788.60

23 RAL colours are shown on page 197

1446mm High

Height (mm)	Width (mm)	Sections	Model	Watts Δt 50°C	Btu's Δt 50°C	White Ex VAT	White Inc VAT	DELIVERY TIMES			
								48-72 HOURS	UP TO 3 WEEKS		UP TO 3 WEEKS
1446	260	3	OSCASI4X3	735	2508	<b>£365.82</b>	<b>£438.98</b>	£515.82	£618.98	£552.39	£662.87
	340	4	OSCASI4X4	980	3344	<b>£487.76</b>	<b>£585.31</b>	£687.76	£825.31	£736.52	£883.82
	420	5	OSCASI4X5	1225	4180	<b>£609.70</b>	<b>£731.64</b>	£859.70	£1,031.64	£920.65	£1,104.78
	500	6	OSCASI4X6	1470	5016	<b>£731.64</b>	<b>£877.97</b>	£1,031.64	£1,237.97	£1,104.78	£1,325.74
	580	7	OSCASI4X7	1715	5852	<b>£853.58</b>	<b>£1,024.30</b>	£1,203.58	£1,444.30	£1,288.91	£1,546.69
	660	8	OSCASI4X8	1960	6688	<b>£975.52</b>	<b>£1,170.62</b>	£1,375.52	£1,650.62	£1,473.04	£1,767.65
	740	9	OSCASI4X9	2205	7523	<b>£1,097.46</b>	<b>£1,316.95</b>	£1,547.46	£1,856.95	£1,657.17	£1,988.60
	820	10	OSCASI4X10	2450	8359	<b>£1,219.40</b>	<b>£1,463.28</b>	£1,719.40	£2,063.28	£1,841.30	£2,209.56

23 RAL colours are shown on page 197

Widths include measurement for bushes

Quoted prices include plugs, bushes, air vent and wall brackets but excludes end panels.

Optional end panels available, please specify at time of order, see page 177 for prices.

OSCA10X6 - 1046mm x 500mm

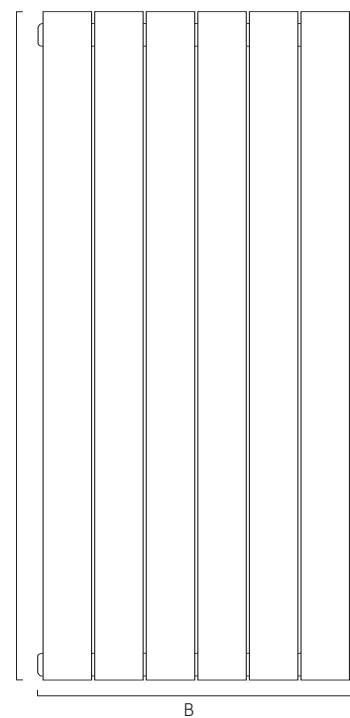

Pipe centres left to right	Pipe centres from wall	Depth from wall
width + valves	67mm to 71mm	114mm to 118mm

Optional end panels available for Oscar range, see page 177 for more information and pricing.

Oscar End Panel



Please specify at time of order

\*Saving based on the value of individual items when bought separately. Order any of our selected valves & matching pipe covers at the same time as your radiator; PROMOVIV (white), PROMOVIC (chrome).

## Assembled stock options RAL 9010

1646mm High

Height (mm)	Width (mm)	Sections	Model	Watts Δt 50°C	Btu's Δt 50°C	White Ex VAT	White Inc VAT	RAL Colours Ex VAT	RAL Colours Inc VAT	Special Finishes Ex VAT	Special Finishes Inc VAT
DELIVERY TIMES						48-72 HOURS		UP TO 3 WEEKS		UP TO 3 WEEKS	
1646	260	3	OSCA16X3	813	2774	£403.65	£484.38	£569.16	£682.99	£609.51	£731.41
	340	4	OSCA16X4	1084	3699	£538.20	£645.84	£758.88	£910.66	£812.68	£975.22
	420	5	OSCA16X5	1355	4623	£672.75	£807.30	£948.60	£1,138.32	£1,015.85	£1,219.02
	500	6	OSCA16X6	1626	5548	£807.30	£968.76	£1,138.32	£1,365.98	£1,219.02	£1,462.82
	580	7	OSCA16X7	1897	6473	£941.85	£1,130.22	£1,328.04	£1,593.65	£1,422.19	£1,706.63
	660	8	OSCA16X8	2168	7397	£1,076.40	£1,291.68	£1,517.76	£1,821.31	£1,625.36	£1,950.43
	740	9	OSCA16X9	2439	8322	£1,210.95	£1,453.14	£1,707.48	£2,048.98	£1,828.53	£2,194.24
	820	10	OSCA16X10	2710	9247	£1,345.50	£1,614.60	£1,897.20	£2,276.64	£2,031.70	£2,438.04

23 RAL colours are shown on page 197

1846mm High

Height (mm)	Width (mm)	Sections	Model	Watts Δt 50°C	Btu's Δt 50°C	White Ex VAT	White Inc VAT	RAL Colours Ex VAT	RAL Colours Inc VAT	Special Finishes Ex VAT	Special Finishes Inc VAT
DELIVERY TIMES						48-72 HOURS		UP TO 3 WEEKS		UP TO 3 WEEKS	
1846	260	3	OSCA18X3	891	3040	£442.92	£531.50	£624.51	£749.41	£668.82	£802.58
	340	4	OSCA18X4	1188	4053	£590.56	£708.67	£832.68	£999.22	£891.76	£1,070.11
	420	5	OSCA18X5	1485	5067	£738.20	£885.84	£1,040.85	£1,249.02	£1,114.70	£1,337.64
	500	6	OSCA18X6	1782	6080	£885.84	£1,063.01	£1,249.02	£1,498.82	£1,337.64	£1,605.17
	580	7	OSCA18X7	2079	7094	£1,033.48	£1,240.18	£1,457.19	£1,748.63	£1,560.58	£1,872.70
	660	8	OSCA18X8	2376	8107	£1,181.12	£1,417.34	£1,665.36	£1,998.43	£1,783.52	£2,140.22
	740	9	OSCA18X9	2673	9120	£1,328.76	£1,594.51	£1,873.53	£2,248.24	£2,006.46	£2,407.75
	820	10	OSCA18X10	2970	10134	£1,476.40	£1,771.68	£2,081.70	£2,498.04	£2,229.40	£2,675.28

23 RAL colours are shown on page 197

2046mm High

Height (mm)	Width (mm)	Sections	Model	Watts Δt 50°C	Btu's Δt 50°C	White Ex VAT	White Inc VAT	RAL Colours Ex VAT	RAL Colours Inc VAT	Special Finishes Ex VAT	Special Finishes Inc VAT
DELIVERY TIMES						48-72 HOURS		UP TO 3 WEEKS		UP TO 3 WEEKS	
2046	260	3	OSCA20X3	963	3286	£497.73	£597.28	£701.79	£842.15	£751.56	£901.87
	340	4	OSCA20X4	1284	4381	£663.64	£796.37	£935.72	£1,122.86	£1,002.08	£1,202.50
	420	5	OSCA20X5	1605	5476	£829.55	£995.46	£1,169.65	£1,403.58	£1,252.60	£1,503.12
	500	6	OSCA20X6	1926	6572	£995.46	£1,194.55	£1,403.58	£1,684.30	£1,503.12	£1,803.74
	580	7	OSCA20X7	2247	7667	£1,161.37	£1,393.64	£1,637.51	£1,965.01	£1,753.64	£2,104.37
	660	8	OSCA20X8	2568	8762	£1,327.28	£1,592.74	£1,871.44	£2,245.73	£2,004.16	£2,404.99
	740	9	OSCA20X9	2889	9857	£1,493.19	£1,791.83	£2,105.37	£2,526.44	£2,254.68	£2,705.62
	820	10	OSCA20X10	3210	10953	£1,659.10	£1,990.92	£2,339.30	£2,807.16	£2,505.20	£3,006.24

23 RAL colours are shown on page 197

Widths include measurement for bushes

Quoted prices include plugs, bushes, air vent and wall brackets but excludes end panels.

Optional end panels available, please specify at time of order, see page 177 for prices.

Pipe centres left to right	Pipe centres from wall	Depth from wall
width + valves	67mm to 71mm	114mm to 118mm

Optional end panels available for Oscar range, see page 177 for more information and pricing



## Stock options by section RAL 9010

Outputs & price given per section, see page 176 for help on sizing your radiator or visit [theradiatorcompany.co.uk](http://theradiatorcompany.co.uk) where you will find our radiator builder.

Height (mm)	Width (mm)	Model	Watts Δt 50°C	Btu's Δt 50°C	White Ex VAT	White Inc VAT	RAL Colours Ex VAT	RAL Colours Inc VAT	Special Finishes Ex VAT	Special Finishes Inc VAT	
DELIVERY TIMES						48-72 HOURS		UP TO 3 WEEKS		UP TO 3 WEEKS	
1046	80	OSCA10	190	648	£75.80	£90.96	£106.88	£128.26	£114.46	£137.35	
1246		OSCA12	218	744	£98.71	£118.45	£139.18	£167.02	£149.05	£178.86	
1446		OSCA14	245	836	£121.94	£146.33	£171.94	£206.33	£184.13	£220.96	
1646		OSCA16	271	925	£134.55	£161.46	£189.72	£227.66	£203.17	£243.80	
1846		OSCA18	297	1013	£147.64	£177.17	£208.17	£249.80	£222.94	£267.53	
2046		OSCA20	321	1095	£165.91	£199.09	£233.93	£280.72	£250.52	£300.62	

23 RAL colours are shown on page 197

Note: Supplied pre-assembled in up to 10 sections (800mm), wider radiators must be joined on site.

Pipe centres left to right	Pipe centres from wall	Depth from wall
no. of sections x 80mm + 20mm bushes + valves	67mm to 71mm	114mm to 118mm

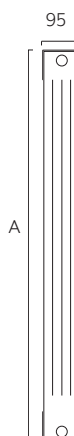

Optional end panels available for Oscar range, see page 177 for more information and pricing.

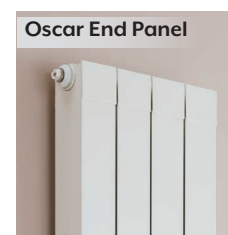

Please specify at time of order



High quality Italian design & manufacture.  
Sectional Aluminium. CE/UKCA approved & certified to BS EN442.



White RAL 9010 as standard, 23 RAL colours plus 30 Special Finishes  
Please call **01342 302250** for a RAL or Special Finish chart  
Colour Coordination Service available, see pages 6-7 for full details.

**Stock White RAL 9010: 48-72 Hours**

Colours & Finishes: Up to 3 weeks (please allow up to 5 weeks for orders of more than 10 radiators in colours or special finishes)

Choose from our assembled stock options or build your own size by individual section, visit [theradiatorcompany.co.uk](http://theradiatorcompany.co.uk) to use our radiator builder.



**SAVE £45** WHEN YOU BUY OUR IDEAL TRV KIT WITH ANY DESIGNER ORDER\* QUOTE **PROMOVI** AT TIME OF ORDER

Available in White or Chrome

**Assembled stock options RAL 9010**

440mm High

Height (mm)	Width (mm)	Sections	Model	Watts Δt 50°C	Btu's Δt 50°C	White		RAL Colours	RAL Colours	Special Finishes	Special Finishes
						Ex VAT	Inc VAT	Ex VAT	Inc VAT	Ex VAT	Inc VAT
DELIVERY TIMES						48-72 HOURS		UP TO 3 WEEKS		UP TO 3 WEEKS	
440	420	5	VOXS44X5	475	1621	£213.80	£256.56	£314.30	£377.16	£337.80	£405.36
	500	6	VOXS44X6	570	1945	£256.56	£307.87	£377.16	£452.59	£405.36	£486.43
	580	7	VOXS44X7	665	2269	£299.32	£359.18	£440.02	£528.02	£472.92	£567.50
	660	8	VOXS44X8	760	2593	£342.08	£410.50	£502.88	£603.46	£540.48	£648.58
	740	9	VOXS44X9	855	2917	£384.84	£461.81	£565.74	£678.89	£608.04	£729.65
	820	10	VOXS44X10	950	3241	£427.60	£513.12	£628.60	£754.32	£675.60	£810.72
	900	11	VOXS44X11	1045	3566	£470.36	£564.43	£691.46	£829.75	£743.16	£891.79
	980	12	VOXS44X12	1140	3890	£513.12	£615.74	£754.32	£905.18	£810.72	£972.86
	1060	13	VOXS44X13	1235	4214	£555.88	£667.06	£817.18	£980.62	£878.28	£1,053.94
	1140	14	VOXS44X14	1330	4538	£598.64	£718.37	£880.04	£1,056.05	£945.84	£1,135.01
	1220	15	VOXS44X15	1425	4862	£641.40	£769.68	£942.90	£1,131.48	£1,013.40	£1,216.08
	1300	16	VOXS44X16	1520	5186	£684.16	£820.99	£1,005.76	£1,206.91	£1,080.96	£1,297.15
	1380	17	VOXS44X17	1615	5510	£726.92	£872.30	£1,068.62	£1,282.34	£1,148.52	£1,378.22
	1460	18	VOXS44X18	1710	5835	£769.68	£923.62	£1,131.48	£1,357.78	£1,216.08	£1,459.30
	1540	19	VOXS44X19	1805	6159	£812.44	£974.93	£1,194.34	£1,433.21	£1,283.64	£1,540.37
	1620	20	VOXS44X20	1900	6483	£855.20	£1,026.24	£1,257.20	£1,508.64	£1,351.20	£1,621.44

23 RAL colours are shown on page 197

Widths include measurement for bushes

Quoted prices include plugs, bushes, air vent and wall brackets.



590mm High

Height (mm)	Width (mm)	Sections	Model	Watts Δt 50°C	Btu's Δt 50°C	White		RAL Colours	RAL Colours	Special Finishes	Special Finishes
						Ex VAT	Inc VAT	Ex VAT	Inc VAT	Ex VAT	Inc VAT
DELIVERY TIMES						48-72 HOURS		UP TO 3 WEEKS		UP TO 3 WEEKS	
590	420	5	VOXS59X5	635	2167	£217.60	£261.12	£319.85	£383.82	£343.80	£412.56
	500	6	VOXS59X6	762	2600	£261.12	£313.34	£383.82	£460.58	£412.56	£495.07
	580	7	VOXS59X7	889	3033	£304.64	£365.57	£447.79	£537.35	£481.32	£577.58
	660	8	VOXS59X8	1016	3467	£348.16	£417.79	£511.76	£614.11	£550.08	£660.10
	740	9	VOXS59X9	1143	3900	£391.68	£470.02	£575.73	£690.88	£618.84	£742.61
	820	10	VOXS59X10	1270	4333	£435.20	£522.24	£639.70	£767.64	£687.60	£825.12
	900	11	VOXS59X11	1397	4767	£478.72	£574.46	£703.67	£844.40	£756.36	£907.63
	980	12	VOXS59X12	1524	5200	£522.24	£626.69	£767.64	£921.17	£825.12	£990.14
	1060	13	VOXS59X13	1651	5633	£565.76	£678.91	£831.61	£997.93	£893.88	£1,072.66
	1140	14	VOXS59X14	1778	6067	£609.28	£731.14	£895.58	£1,074.70	£962.64	£1,155.17
	1220	15	VOXS59X15	1905	6500	£652.80	£783.36	£959.55	£1,151.46	£1,031.40	£1,237.68
	1300	16	VOXS59X16	2032	6933	£696.32	£835.58	£1,023.52	£1,228.22	£1,100.16	£1,320.19
	1380	17	VOXS59X17	2159	7367	£739.84	£887.81	£1,087.49	£1,304.99	£1,168.92	£1,402.70
	1460	18	VOXS59X18	2286	7800	£783.36	£940.03	£1,151.46	£1,381.75	£1,237.68	£1,485.22
	1540	19	VOXS59X19	2413	8233	£826.88	£992.26	£1,215.43	£1,458.52	£1,306.44	£1,567.73
	1620	20	VOXS59X20	2540	8666	£870.40	£1,044.48	£1,279.40	£1,535.28	£1,375.20	£1,650.24

23 RAL colours are shown on page 197

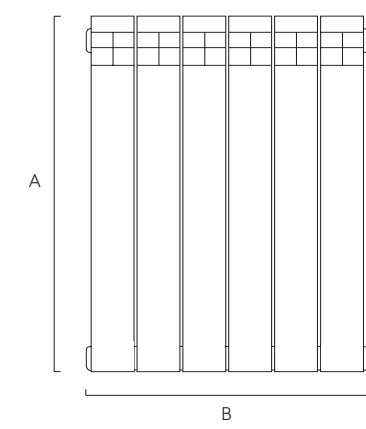

Pipe centres left to right	Pipe centres from wall	Depth from wall
width + valves	67mm to 71mm	114mm to 118mm

\*Saving based on the value of individual items when bought separately. Order any of our selected valves & matching pipe covers at the same time as your radiator; PROMOVIW (white), PROMOVIC (chrome).

## Assembled stock options RAL 9010

690mm High

Height (mm)	Width (mm)	Sections	Model	Watts Δt 50°C	Btu's Δt 50°C	White Ex VAT	White Inc VAT	RAL Colours Ex VAT	RAL Colours Inc VAT	Special Finishes Ex VAT	Special Finishes Inc VAT
DELIVERY TIMES						48-72 HOURS		UP TO 3 WEEKS		UP TO 3 WEEKS	
690	420	5	VOXS69X5	730	2491	£225.50	£270.60	£331.50	£397.80	£356.30	£427.56
	500	6	VOXS69X6	876	2989	£270.60	£324.72	£397.80	£477.36	£427.56	£513.07
	580	7	VOXS69X7	1022	3487	£315.70	£378.84	£464.10	£556.92	£498.82	£598.58
	660	8	VOXS69X8	1168	3985	£360.80	£432.96	£530.40	£636.48	£570.08	£684.10
	740	9	VOXS69X9	1314	4483	£405.90	£487.08	£596.70	£716.04	£641.34	£769.61
	820	10	VOXS69X10	1460	4982	£451.00	£541.20	£663.00	£795.60	£712.60	£855.12
	900	11	VOXS69X11	1606	5480	£496.10	£595.32	£729.30	£875.16	£783.86	£940.63
	980	12	VOXS69X12	1752	5978	£541.20	£649.44	£795.60	£954.72	£855.12	£1,026.14
	1060	13	VOXS69X13	1898	6476	£586.30	£703.56	£861.90	£1,034.28	£926.38	£1,111.66
	1140	14	VOXS69X14	2044	6974	£631.40	£757.68	£928.20	£1,113.84	£997.64	£1,197.17
	1220	15	VOXS69X15	2190	7472	£676.50	£811.80	£994.50	£1,193.40	£1,068.90	£1,282.68
	1300	16	VOXS69X16	2336	7970	£721.60	£865.92	£1,060.80	£1,272.96	£1,140.16	£1,368.19
	1380	17	VOXS69X17	2482	8469	£766.70	£920.04	£1,127.10	£1,352.52	£1,211.42	£1,453.70
	1460	18	VOXS69X18	2628	8967	£811.80	£974.16	£1,193.40	£1,432.08	£1,282.68	£1,539.22
	1540	19	VOXS69X19	2774	9465	£856.90	£1,028.28	£1,259.70	£1,511.64	£1,353.94	£1,624.73
	1620	20	VOXS69X20	2920	9963	£902.00	£1,082.40	£1,326.00	£1,591.20	£1,425.20	£1,710.24

23 RAL colours are shown on page 197

1646mm High

Height (mm)	Width (mm)	Sections	Model	Watts Δt 50°C	Btu's Δt 50°C	White Ex VAT	White Inc VAT	RAL Colours Ex VAT	RAL Colours Inc VAT	Special Finishes Ex VAT	Special Finishes Inc VAT
DELIVERY TIMES						48-72 HOURS		UP TO 3 WEEKS		UP TO 3 WEEKS	
1646	260	3	VOXS16X3	813	2774	£408.03	£489.64	£599.79	£719.75	£644.70	£773.64
	340	4	VOXS16X4	1084	3699	£544.04	£652.85	£799.72	£959.66	£859.60	£1,031.52
	420	5	VOXS16X5	1355	4623	£680.05	£816.06	£999.65	£1,199.58	£1,074.50	£1,289.40
	500	6	VOXS16X6	1626	5548	£816.06	£979.27	£1,199.58	£1,439.50	£1,289.40	£1,547.28
	580	7	VOXS16X7	1897	6473	£952.07	£1,142.48	£1,399.51	£1,679.41	£1,504.30	£1,805.16
	660	8	VOXS16X8	2168	7397	£1,088.08	£1,305.70	£1,599.44	£1,919.33	£1,719.20	£2,063.04
	740	9	VOXS16X9	2439	8322	£1,224.09	£1,468.91	£1,799.37	£2,159.24	£1,934.10	£2,320.92
	820	10	VOXS16X10	2710	9247	£1,360.10	£1,632.12	£1,999.30	£2,399.16	£2,149.00	£2,578.80

23 RAL colours are shown on page 197

1846mm High

Height (mm)	Width (mm)	Sections	Model	Watts Δt 50°C	Btu's Δt 50°C	White Ex VAT	White Inc VAT	RAL Colours Ex VAT	RAL Colours Inc VAT	Special Finishes Ex VAT	Special Finishes Inc VAT
DELIVERY TIMES						48-72 HOURS		UP TO 3 WEEKS		UP TO 3 WEEKS	
1846	260	3	VOXS18X3	891	3040	£444.75	£533.70	£653.79	£784.55	£702.72	£843.26
	340	4	VOXS18X4	1188	4053	£593.00	£711.60	£871.72	£1,046.06	£936.96	£1,124.35
	420	5	VOXS18X5	1485	5067	£741.25	£889.50	£1,089.65	£1,307.58	£1,171.20	£1,405.44
	500	6	VOXS18X6	1782	6080	£889.50	£1,067.40	£1,307.58	£1,569.10	£1,405.44	£1,686.53
	580	7	VOXS18X7	2079	7094	£1,037.75	£1,245.30	£1,525.51	£1,830.61	£1,639.68	£1,967.62
	660	8	VOXS18X8	2376	8107	£1,186.00	£1,423.20	£1,743.44	£2,092.13	£1,873.92	£2,248.70
	740	9	VOXS18X9	2673	9120	£1,334.25	£1,601.10	£1,961.37	£2,353.64	£2,108.16	£2,529.79
	820	10	VOXS18X10	2970	10134	£1,482.50	£1,779.00	£2,179.30	£2,615.16	£2,342.40	£2,810.88

23 RAL colours are shown on page 197

Widths include measurement for bushes  
Quoted prices include plugs, bushes, air vent and wall brackets.

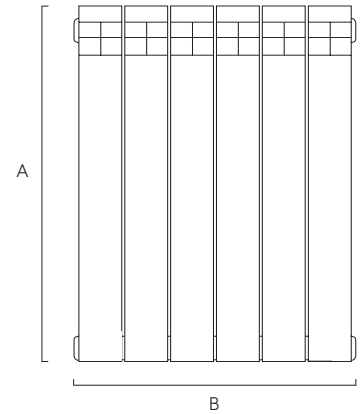

Pipe centres left to right	Pipe centres from wall	Depth from wall
width + valves	67mm to 71mm	114mm to 118mm

## Stock options by section RAL 9010

Outputs & price given per section, see page 176 for help on sizing your radiator or visit [theradiatorcompany.co.uk](http://theradiatorcompany.co.uk) where you will find our radiator builder.

Height (mm)	Width (mm)	Model	Watts Δt 50°C	Btu's Δt 50°C	White Ex VAT	White Inc VAT	RAL Colours Ex VAT	RAL Colours Inc VAT	Special Finishes Ex VAT	Special Finishes Inc VAT	
DELIVERY TIMES						48-72 HOURS		UP TO 3 WEEKS		UP TO 3 WEEKS	
440	80	VOX44	95	324	£42.76	£51.31	£62.86	£75.43	£67.56	£81.07	
590		VOX59	127	433	£43.52	£52.22	£63.97	£76.76	£68.76	£82.51	
690		VOX69	146	498	£45.10	£54.12	£66.30	£79.56	£71.26	£85.51	
1646		VOX16	271	925	£136.01	£163.21	£199.93	£239.92	£214.90	£257.88	
1846		VOX18	297	1013	£148.25	£177.90	£217.93	£261.52	£234.24	£281.09	

23 RAL colours are shown on page 197

Pipe centres left to right	Pipe centres from wall	Depth from wall
number of sections x 80mm + 20mm bushes + valves	67mm to 71mm	114mm to 118mm

Note: Supplied pre-assembled in up to 20 sections (1600mm), wider radiators must be joined on site.

1646mm & 1846mm supplied pre-assembled in up to 10 sections (800mm), wider radiators must be joined on site.



High quality Italian design & manufacture.  
Sectional Aluminium. CE/UKCA approved & certified to BS EN442.



White RAL 9010 as standard, 23 RAL colours plus 30 Special Finishes  
Please call **01342 302250** for a RAL or Special Finish chart  
Colour Coordination Service available, see pages 6-7 for full details.

**Stock White RAL 9010: 48-72 Hours**

Colours & Finishes: Up to 3 weeks (please allow up to 5 weeks for orders of more than 10 radiators in colours or special finishes)

Choose from our assembled stock options or build your own size by individual section, visit [theradiatorcompany.co.uk](http://theradiatorcompany.co.uk) to use our radiator builder.



**SAVE £45** WHEN YOU BUY OUR **IDEAL TRV KIT** WITH ANY DESIGNER ORDER\*  
QUOTE **PROMOVI** AT TIME OF ORDER  
Available in White or Chrome



**Assembled stock options RAL 9010**

390mm High

Height (mm)	Width (mm)	Sections	Model	Watts Δt 50°C	Btu's Δt 50°C	White		RAL	RAL	Special	Special
						Ex VAT	Inc VAT	Colours Ex VAT	Colours Inc VAT	Finishes Ex VAT	Finishes Inc VAT
DELIVERY TIMES						48-72 HOURS		UP TO 3 WEEKS		UP TO 3 WEEKS	
390	420	5	MIXS39X5	410	1399	£209.40	£251.28	£305.70	£366.84	£330.85	£397.02
	500	6	MIXS39X6	492	1679	£251.28	£301.54	£366.84	£440.21	£397.02	£476.42
	580	7	MIXS39X7	574	1958	£293.16	£351.79	£427.98	£513.58	£463.19	£555.83
	660	8	MIXS39X8	656	2238	£335.04	£402.05	£489.12	£586.94	£529.36	£635.23
	740	9	MIXS39X9	738	2518	£376.92	£452.30	£550.26	£660.31	£595.53	£714.64
	820	10	MIXS39X10	820	2798	£418.80	£502.56	£611.40	£733.68	£661.70	£794.04
	900	11	MIXS39X11	902	3078	£460.68	£552.82	£672.54	£807.05	£727.87	£873.44
	980	12	MIXS39X12	984	3357	£502.56	£603.07	£733.68	£880.42	£794.04	£952.85
	1060	13	MIXS39X13	1066	3637	£544.44	£653.33	£794.82	£953.78	£860.21	£1,032.25
	1140	14	MIXS39X14	1148	3917	£586.32	£703.58	£855.96	£1,027.15	£926.38	£1,111.66
	1220	15	MIXS39X15	1230	4197	£628.20	£753.84	£917.10	£1,100.52	£992.55	£1,191.06
	1300	16	MIXS39X16	1312	4477	£670.08	£804.10	£978.24	£1,173.89	£1,058.72	£1,270.46
	1380	17	MIXS39X17	1394	4756	£711.96	£854.35	£1,039.38	£1,247.26	£1,124.89	£1,349.87
	1460	18	MIXS39X18	1476	5036	£753.84	£904.61	£1,100.52	£1,320.62	£1,191.06	£1,429.27
1540	19	MIXS39X19	1558	5316	£795.72	£954.86	£1,161.66	£1,393.99	£1,257.23	£1,508.68	
1620	20	MIXS39X20	1640	5596	£837.60	£1,005.12	£1,222.80	£1,467.36	£1,323.40	£1,588.08	

23 RAL colours are shown on page 197

440mm High

Height (mm)	Width (mm)	Sections	Model	Watts Δt 50°C	Btu's Δt 50°C	White		RAL	RAL	Special	Special
						Ex VAT	Inc VAT	Colours Ex VAT	Colours Inc VAT	Finishes Ex VAT	Finishes Inc VAT
DELIVERY TIMES						48-72 HOURS		UP TO 3 WEEKS		UP TO 3 WEEKS	
440	420	5	MIXS44X5	470	1604	£213.80	£256.56	£312.15	£374.58	£337.80	£405.36
	500	6	MIXS44X6	564	1924	£256.56	£307.87	£374.58	£449.50	£405.36	£486.43
	580	7	MIXS44X7	658	2245	£299.32	£359.18	£437.01	£524.41	£472.92	£567.50
	660	8	MIXS44X8	752	2566	£342.08	£410.50	£499.44	£599.33	£540.48	£648.58
	740	9	MIXS44X9	846	2887	£384.84	£461.81	£561.87	£674.24	£608.04	£729.65
	820	10	MIXS44X10	940	3207	£427.60	£513.12	£624.30	£749.16	£675.60	£810.72
	900	11	MIXS44X11	1034	3528	£470.36	£564.43	£686.73	£824.08	£743.16	£891.79
	980	12	MIXS44X12	1128	3849	£513.12	£615.74	£749.16	£898.99	£810.72	£972.86
	1060	13	MIXS44X13	1222	4169	£555.88	£667.06	£811.59	£973.91	£878.28	£1,053.94
	1140	14	MIXS44X14	1316	4490	£598.64	£718.37	£874.02	£1,048.82	£945.84	£1,135.01
	1220	15	MIXS44X15	1410	4811	£641.40	£769.68	£936.45	£1,123.74	£1,013.40	£1,216.08
	1300	16	MIXS44X16	1504	5132	£684.16	£820.99	£998.88	£1,198.66	£1,080.96	£1,297.15
	1380	17	MIXS44X17	1598	5452	£726.92	£872.30	£1,061.31	£1,273.57	£1,148.52	£1,378.22
	1460	18	MIXS44X18	1692	5773	£769.68	£923.62	£1,123.74	£1,348.49	£1,216.08	£1,459.30
1540	19	MIXS44X19	1786	6094	£812.44	£974.93	£1,186.17	£1,423.40	£1,283.64	£1,540.37	
1620	20	MIXS44X20	1880	6415	£855.20	£1,026.24	£1,248.60	£1,498.32	£1,351.20	£1,621.44	

23 RAL colours are shown on page 197

Widths include measurement for bushes

Quoted prices include plugs, bushes, air vent and wall brackets.

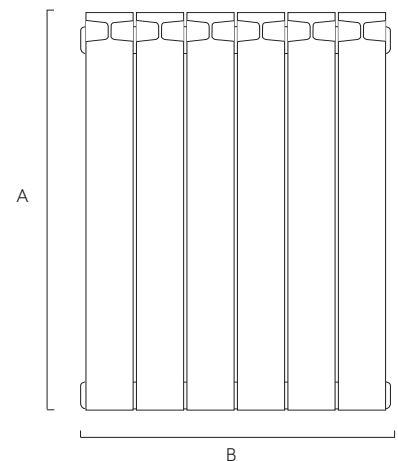

Pipe centres left to right	Pipe centres from wall	Depth from wall
width + valves	67mm to 71mm	114mm to 118mm

\*Saving based on the value of individual items when bought separately. Order any of our selected valves & matching pipe covers at the same time as your radiator; PROMOVIW (white), PROMOVIC (chrome).



## Assembled stock options RAL 9010

590mm High

Height (mm)	Width (mm)	Sections	Model	Watts Δt 50°C	Btu's Δt 50°C	White Ex VAT	White Inc VAT	RAL Colours Ex VAT	RAL Colours Inc VAT	Special Finishes Ex VAT	Special Finishes Inc VAT
DELIVERY TIMES						48-72 HOURS		UP TO 3 WEEKS		UP TO 3 WEEKS	
590	420	5	MIXS59X5	615	2098	£217.60	£261.12	£317.70	£381.24	£343.80	£412.56
	500	6	MIXS59X6	738	2518	£261.12	£313.34	£381.24	£457.49	£412.56	£495.07
	580	7	MIXS59X7	861	2938	£304.64	£365.57	£444.78	£533.74	£481.32	£577.58
	660	8	MIXS59X8	984	3357	£348.16	£417.79	£508.32	£609.98	£550.08	£660.10
	740	9	MIXS59X9	1107	3777	£391.68	£470.02	£571.86	£686.23	£618.84	£742.61
	820	10	MIXS59X10	1230	4197	£435.20	£522.24	£635.40	£762.48	£687.60	£825.12
	900	11	MIXS59X11	1353	4616	£478.72	£574.46	£698.94	£838.73	£756.36	£907.63
	980	12	MIXS59X12	1476	5036	£522.24	£626.69	£762.48	£914.98	£825.12	£990.14
	1060	13	MIXS59X13	1599	5456	£565.76	£678.91	£826.02	£991.22	£893.88	£1,072.66
	1140	14	MIXS59X14	1722	5875	£609.28	£731.14	£889.56	£1,067.47	£962.64	£1,155.17
	1220	15	MIXS59X15	1845	6295	£652.80	£783.36	£953.10	£1,143.72	£1,031.40	£1,237.68
	1300	16	MIXS59X16	1968	6715	£696.32	£835.58	£1,016.64	£1,219.97	£1,100.16	£1,320.19
	1380	17	MIXS59X17	2091	7134	£739.84	£887.81	£1,080.18	£1,296.22	£1,168.92	£1,402.70
	1460	18	MIXS59X18	2214	7554	£783.36	£940.03	£1,143.72	£1,372.46	£1,237.68	£1,485.22
	1540	19	MIXS59X19	2337	7974	£826.88	£992.26	£1,207.26	£1,448.71	£1,306.44	£1,567.73
	1620	20	MIXS59X20	2460	8394	£870.40	£1,044.48	£1,270.80	£1,524.96	£1,375.20	£1,650.24

23 RAL colours are shown on page 197

Widths include measurement for bushes

Quoted prices include plugs, bushes, air vent and wall brackets.



690mm High

Height (mm)	Width (mm)	Sections	Model	Watts Δt 50°C	Btu's Δt 50°C	White Ex VAT	White Inc VAT	RAL Colours Ex VAT	RAL Colours Inc VAT	Special Finishes Ex VAT	Special Finishes Inc VAT
DELIVERY TIMES						48-72 HOURS		UP TO 3 WEEKS		UP TO 3 WEEKS	
690	420	5	MIXS69X5	710	2423	£225.50	£270.60	£329.25	£395.10	£356.30	£427.56
	500	6	MIXS69X6	852	2907	£270.60	£324.72	£395.10	£474.12	£427.56	£513.07
	580	7	MIXS69X7	994	3392	£315.70	£378.84	£460.95	£553.14	£498.82	£598.58
	660	8	MIXS69X8	1136	3876	£360.80	£432.96	£526.80	£632.16	£570.08	£684.10
	740	9	MIXS69X9	1278	4361	£405.90	£487.08	£592.65	£711.18	£641.34	£769.61
	820	10	MIXS69X10	1420	4845	£451.00	£541.20	£658.50	£790.20	£712.60	£855.12
	900	11	MIXS69X11	1562	5330	£496.10	£595.32	£724.35	£869.22	£783.86	£940.63
	980	12	MIXS69X12	1704	5814	£541.20	£649.44	£790.20	£948.24	£855.12	£1,026.14
	1060	13	MIXS69X13	1846	6299	£586.30	£703.56	£856.05	£1,027.26	£926.38	£1,111.66
	1140	14	MIXS69X14	1988	6783	£631.40	£757.68	£921.90	£1,106.28	£997.64	£1,197.17
	1220	15	MIXS69X15	2130	7268	£676.50	£811.80	£987.75	£1,185.30	£1,068.90	£1,282.68
	1300	16	MIXS69X16	2272	7752	£721.60	£865.92	£1,053.60	£1,264.32	£1,140.16	£1,368.19
	1380	17	MIXS69X17	2414	8237	£766.70	£920.04	£1,119.45	£1,343.34	£1,211.42	£1,453.70
	1460	18	MIXS69X18	2556	8721	£811.80	£974.16	£1,185.30	£1,422.36	£1,282.68	£1,539.22
	1540	19	MIXS69X19	2698	9206	£856.90	£1,028.28	£1,251.15	£1,501.38	£1,353.94	£1,624.73
	1620	20	MIXS69X20	2840	9690	£902.00	£1,082.40	£1,317.00	£1,580.40	£1,425.20	£1,710.24

23 RAL colours are shown on page 197

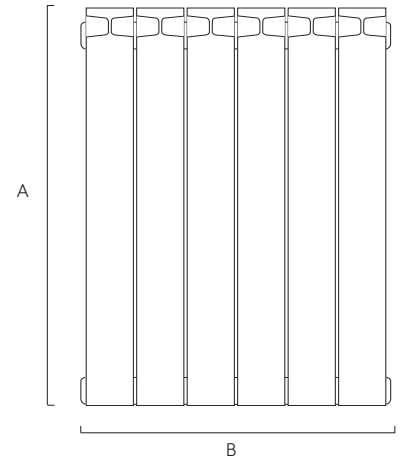

## Stock options by section RAL 9010

Outputs & price given per section, see page 176 for help on sizing your radiator or visit [theradiatorcompany.co.uk](http://theradiatorcompany.co.uk) where you will find our radiator builder.

Height (mm)	Width (mm)	Model	Watts Δt 50°C	Btu's Δt 50°C	White Ex VAT	White Inc VAT	RAL Colours Ex VAT	RAL Colours Inc VAT	Special Finishes Ex VAT	Special Finishes Inc VAT	
DELIVERY TIMES						48-72 HOURS		UP TO 3 WEEKS		UP TO 3 WEEKS	
390	80	MIX39	82	280	£41.88	£50.26	£61.14	£73.37	£66.17	£79.40	
440		MIX44	94	321	£42.76	£51.31	£62.43	£74.92	£67.56	£81.07	
590		MIX59	123	420	£43.52	£52.22	£63.54	£76.25	£68.76	£82.51	
690		MIX69	142	485	£45.10	£54.12	£65.85	£79.02	£71.26	£85.51	

Pipe centres left to right	Pipe centres from wall	Depth from wall
number of sections x 80mm + 20mm bushes + valves	67mm to 71mm	114mm to 118mm

Note: Supplied pre-assembled in up to 20 sections (1600mm), wider radiators must be joined on site.

23 RAL colours available for your Aluminium radiator to be painted in see page 197 for full range

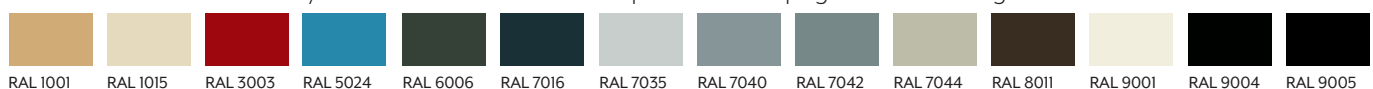

# Cast Iron

Our cast iron range includes a choice of ornate and plain schoolhouse designs. Available in a choice of finishes, including painted, polished and burnished, cast iron radiators can be specified by section so you can choose the right size for your space.



**SAVE £45**  
WHEN YOU BUY OUR **VINTAGE TRV KIT** WITH ANY CAST IRON ORDER\*  
PLEASE QUOTE **PROMOV2** AT TIME OF ORDER

\*Saving based on the value of individual items when bought separately. Order any of our selected valves and matching pipe covers at the same time as your radiator.

## Choose your radiator using our NEW online radiator builder

Once you know your outputs use our **online radiator builder** to select the best solution for your room. It will take you through the process quickly and easily and allows you to save your ideas to your own Wish List.

Go to our website [theradiatorcompany.co.uk](http://theradiatorcompany.co.uk)

It is vital to know the correct heat output you need to keep your room warm, use our online Heat Output Calculator to get a guide to your requirements which you can then check with your installer.

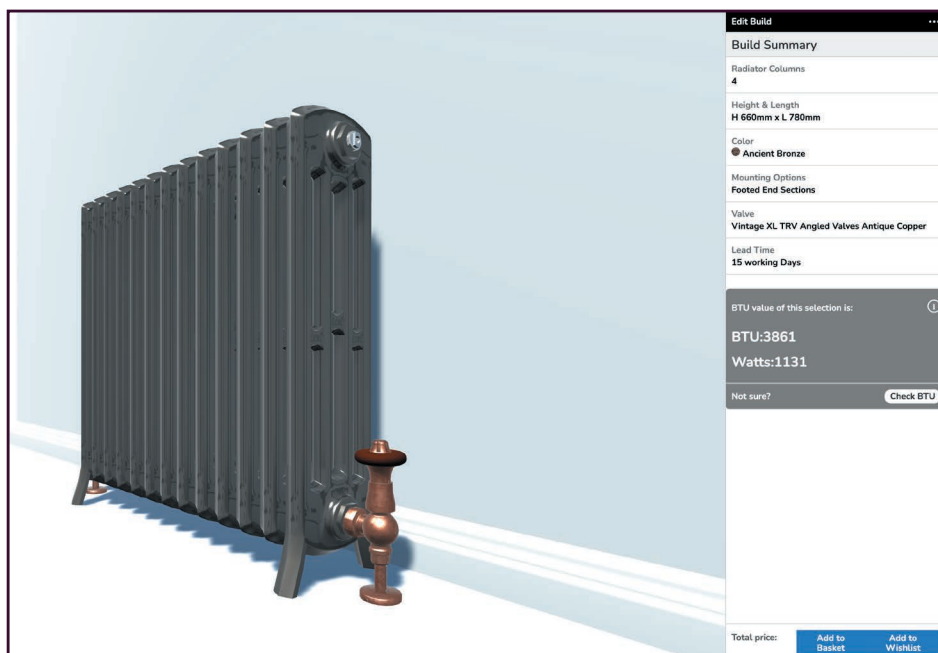

Once you know your outputs you can also use the brochure to specify your radiator by following these steps (or call our Customer Services team on 01342 302250 who will help you size your radiator)

- Note the space you have in mind for the radiator(s) you need; vertical or horizontal, length, height & depth
- Select a column option and height that fits your space; Calculate the number of sections you need by dividing the required BTU (Watt) output with the output per section; e.g 1913 BTUs divided by 328 = 6 sections, based on 4 column, 580mm high sections (always round up to the next whole number of sections)
- If using that section size doesn't work in the space available, try a different column option or if possible a different height
- Once you have calculated the best number and size of section, select the best mounting option and kit; footed end section, cast feet or wall brackets. For the Telford and Ledbury you have the option of footed ends (selected sizes on Telford), cast feet or wall brackets. Aston, Trieste, Bohemia and Linton ranges are only available with footed ends.
- Your cast iron radiator can be painted in a selection of the most popular colours from the RAL range, special finishes, in a polished or burnished finished (Trieste) or a lacquered finish. Please specify your chosen colour at time of order. Please note: as a result of the casting process, cast iron radiators have a rough surface finish with small imperfections which will show after the painting process.
- Work out the price of your radiator; e.g Telford 4 column, 580 high, 6 section, RAL 7044 Silk Grey = £104.64 x 6 = £627.84 + Cast feet Kit (2) = £95.26 - Total = £723.10
- Place your order with your local Merchant using the sectional model code x No. of sections needed, noting the mounting option and the name and number of colour you have chosen; e.g TELF4C58 x 6 sections, RAL 7044 Silk Grey with cast feet
- If you have chosen a colour make sure you list the colour number and name

All prices and outputs are given per section in the tables on pages 189-195. Price per section includes plugs, bushes and diverter. Mounting options must be selected separately, these will include the air vent and appropriate number of wall ties.

# Aston shown on pages 78-79 New Sizes

Cast Iron; 2, 3, 4 & 6 column, footed ends as standard  
CE/UKCA approved & certified to BS EN442.

24 RAL colours (shown on page 197) and a Polished finish.  
Please call **01342 302250** for a RAL chart

24 RAL colours: up to 6 weeks  
Polished: up to 6 weeks  
Please add 10 working days for orders of more than 10 radiators



**SAVE £45** WHEN YOU BUY OUR **VINTAGE TRV KIT** WITH ANY CAST IRON ORDER\*  
QUOTING **PROMOV2** AT TIME OF ORDER

For all Vintage TRV finishes

## Aston Sectional options with footed end sections as standard

Build your radiator to fit your requirements using individual sections shown below, visit page 188 to help you size your radiator.  
Please note section prices are based on 8 sections or more, for anything less than 8 sections prices will be on application.  
If you require more than 40 sections please contact our Customer Services team on **01342 302250**.

### 2 Column

Height A (mm)	Width B (mm)	Model	Watts Δt 50°C	Btu's Δt 50°C	RAL Colours Ex VAT	RAL Colours Inc VAT	Polished Ex VAT	Polished Inc VAT
DELIVERY TIMES					UP TO 6 WEEKS		UP TO 6 WEEKS	
460	58.5	ASTO2C46	35	119	£55.64	£66.77	£105.72	£126.86
760	58.5	ASTO2C76	59	201	£65.07	£78.08	£123.63	£148.36
960	58.5	ASTO2C96	74	252	£73.17	£87.80	£139.02	£166.82

### 3 Column

Height A (mm)	Width B (mm)	Model	Watts Δt 50°C	Btu's Δt 50°C	RAL Colours Ex VAT	RAL Colours Inc VAT	Polished Ex VAT	Polished Inc VAT
DELIVERY TIMES					UP TO 6 WEEKS		UP TO 6 WEEKS	
560	58.5	ASTO3C56	54	184	£68.17	£81.80	£129.52	£155.42
660	58.5	ASTO3C66	66	225	£75.82	£90.98	£144.06	£172.87
760	58.5	ASTO3C76	78	266	£78.02	£93.62	£148.24	£177.89
860	58.5	ASTO3C86	87	297	£88.94	£106.73	£168.99	£202.79

### 4 Column

Height A (mm)	Width B (mm)	Model	Watts Δt 50°C	Btu's Δt 50°C	RAL Colours Ex VAT	RAL Colours Inc VAT	Polished Ex VAT	Polished Inc VAT
DELIVERY TIMES					UP TO 6 WEEKS		UP TO 6 WEEKS	
360	58.5	ASTO4C36	45	154	£61.14	£73.37	£116.17	£139.40
460	58.5	ASTO4C46	58	198	£68.91	£82.69	£130.93	£157.12
560	58.5	ASTO4C56	69	235	£79.52	£95.42	£151.09	£181.31
760	58.5	ASTO4C76	96	328	£98.68	£118.42	£187.49	£224.99
860	58.5	ASTO4C86	109	372	£105.30	£126.36	£200.07	£240.08
960	58.5	ASTO4C96	121	413	£119.99	£143.99	£227.98	£273.58

### 6 Column

Height A (mm)	Width B (mm)	Model	Watts Δt 50°C	Btu's Δt 50°C	RAL Colours Ex VAT	RAL Colours Inc VAT	Polished Ex VAT	Polished Inc VAT
DELIVERY TIMES					UP TO 6 WEEKS		UP TO 6 WEEKS	
960	58.5	ASTO6C96	168	573	£148.81	£178.57	£282.74	£339.29

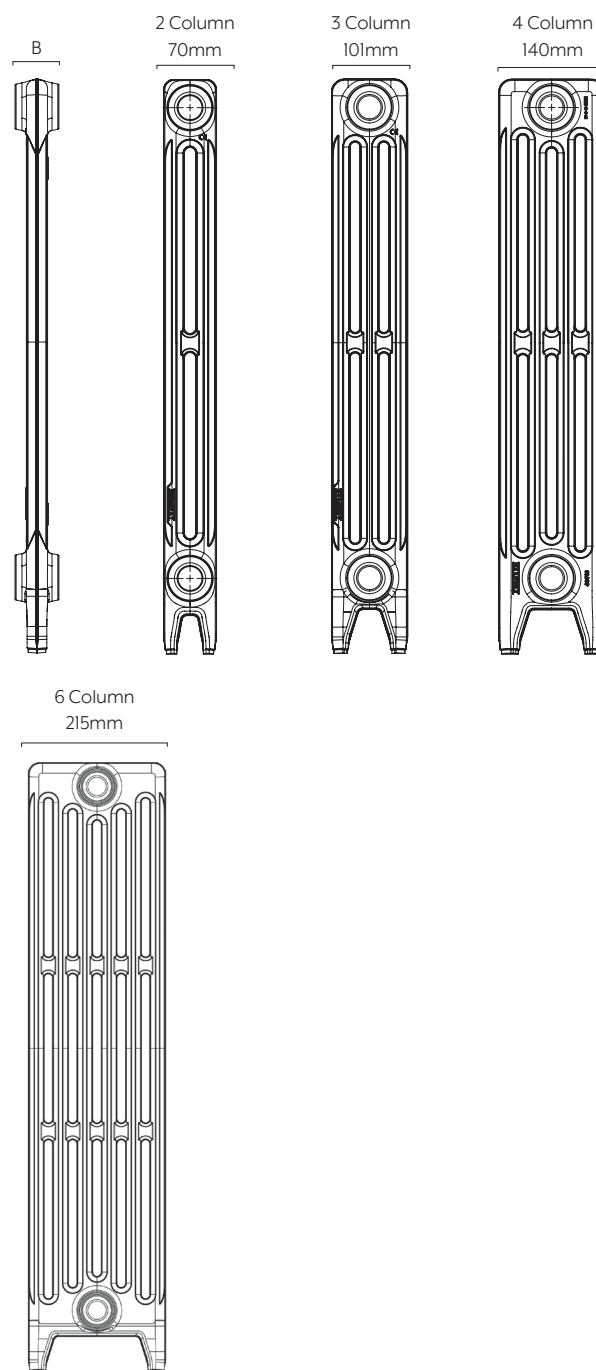

Aston	Pipe centres left to right	Pipe centres from wall
2 Column	58.5 x number of sections + 25mm bushes + valves	68mm to 83mm
3 Column	58.5 x number of sections + 25mm bushes + valves	84mm to 99mm
4 Column	58.5 x number of sections + 25mm bushes + valves	103mm to 118mm
6 Column	58.5 x number of sections + 25mm bushes + valves	140mm to 155mm

\*Saving based on the value of individual items when bought separately. Order any of our selected valves and matching pipe covers at the same time as your radiator.

# Ledbury shown on pages 76-77

Cast Iron; 4 or 6 column footed ends as standard, optional cast feet or wall brackets available. CE/UKCA approved & certified to BS EN442.



Supplied in a standard primer, ready to be painted in your desired finish.

24 RAL colours (shown on page 197) and 29 special finishes.

Please call **01342 302250** for a RAL or Special Finish chart.

Colour Coordination Service available, see pages 6-7 for full details.

**Stock Primer: 5-7 working days.** RAL colours & special finishes: up to 3 weeks,

Please add 10 working days for orders of more than 10 radiators.



**SAVE £45** WHEN YOU BUY OUR **VINTAGE TRV KIT** WITH ANY CAST IRON ORDER\* QUOTING **PROMOV2** AT TIME OF ORDER

For all Vintage TRV finishes

## Ledbury Sectional options

Available with footed end sections as standard, wall brackets and cast feet are also available.

Please see alternative mounting options on page 189 or call customer services on **01342 302250** for more information and prices.

Build your radiator to fit your requirements using individual sections shown below, visit page 188 to help you size your radiator.

If you require more than 40 sections please contact our Customer Services team on **01342 302250**.

### 4 Column

Height A (mm)	Width B (mm)	Model	Watts Δt 50°C	Btu's Δt 50°C	Primer Ex VAT	Primer Inc VAT	RAL Colours Ex VAT	RAL Colours Inc VAT	Special Finishes Ex VAT	Special Finishes Inc VAT
DELIVERY TIMES					5-7 WORKING DAYS		UP TO 3 WEEKS		UP TO 3 WEEKS	
660	60	NLEDB4C65	87	297	£47.20	£56.64	£75.52	£90.62	£89.68	£107.62
760	60	NLEDB4C76	101	345	£60.05	£72.06	£96.08	£115.30	£114.10	£136.92
960	60	NLEDB4C95	125	427	£70.77	£84.92	£113.23	£135.88	£134.46	£161.35

4 column



### 6 Column

Height A (mm)	Width B (mm)	Model	Watts Δt 50°C	Btu's Δt 50°C	Primer Ex VAT	Primer Inc VAT	RAL Colours Ex VAT	RAL Colours Inc VAT	Special Finishes Ex VAT	Special Finishes Inc VAT
DELIVERY TIMES					5-7 WORKING DAYS		UP TO 3 WEEKS		UP TO 3 WEEKS	
665	60	NLEDB6C65	127	433	£68.64	£82.37	£109.82	£131.78	£130.42	£156.50
760	60	NLEDB6C76	147	502	£89.51	£107.41	£143.22	£171.86	£170.07	£204.08

6 column

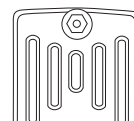

### 4 Column Mini Ledbury

Height A (mm)	Width B (mm)	Model	Watts Δt 50°C	Btu's Δt 50°C	Primer Ex VAT	Primer Inc VAT	RAL Colours Ex VAT	RAL Colours Inc VAT	Special Finishes Ex VAT	Special Finishes Inc VAT
DELIVERY TIMES					5-7 WORKING DAYS		UP TO 3 WEEKS		UP TO 3 WEEKS	
355	60	NMINLEDB4C35	46	157	£33.56	£40.27	£53.70	£64.44	£63.76	£76.51
475	60	NMINLEDB4C47	62	212	£42.27	£50.72	£67.63	£81.16	£80.31	£96.37

4 column



### 6 Column Mini Ledbury

Height A (mm)	Width B (mm)	Model	Watts Δt 50°C	Btu's Δt 50°C	Primer Ex VAT	Primer Inc VAT	RAL Colours Ex VAT	RAL Colours Inc VAT	Special Finishes Ex VAT	Special Finishes Inc VAT
DELIVERY TIMES					5-7 WORKING DAYS		UP TO 3 WEEKS		UP TO 3 WEEKS	
485	60	NMINLEDB6C48	94	321	£53.61	£64.33	£85.78	£102.94	£101.86	£122.23

6 column

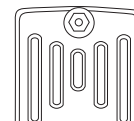

Ledbury	Pipe centres left to right	Pipe centres from wall	Footed end section depth	Section depth
4 Column	60 x number of sections + 28mm bushes + valves	105mm to 120mm	174mm (footed ends protrude 31mm total from section width)	143mm
Mini 4 Column	60 x number of sections + 28mm bushes + valves	105mm to 120mm	174mm (footed ends protrude 30mm total from section width)	144mm
6 Column	60 x number of sections + 28mm bushes + valves	130mm to 150mm	250mm (footed ends protrude 28mm total from section width)	222mm
Mini 6 Column	60 x number of sections + 28mm bushes + valves	130mm to 150mm	255mm (footed ends protrude 33mm total from section width)	222mm

4 Column

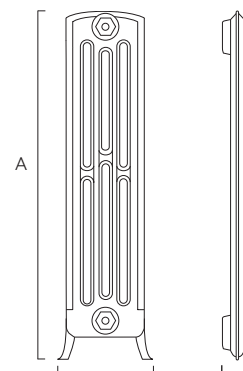

footed end section depth = 174mm

Please note for sections without footed ends deduct 60mm from the height of the section

\*Saving based on the value of individual items when bought separately. Order any of our selected valves & matching pipe covers at the same time as your radiator.

# Optional cast iron cast feet for Ledbury

If you require optional cast feet please specify at time of order by adding the relevant kit and price below.

Wall Brackets are also available on request, please call 01342 302250 to discuss with our customer service team.

Up to 20 Sections	21 - 39 Sections (odd number of sections)	22 - 40 Sections (even number of sections)
2 Feet - 1 at each end	3 Feet - 1 at each end and 1 positioned centrally	4 Feet - 1 at each end and 2 spaced equally inbetween
2 Wall Ties	3 Wall Ties	4 Wall Ties

Wall Ties are included in the price and supplied as standard for all orders. Please specify your chosen mounting option at time of order.

Model	Number of Feet	Primer Ex VAT	Primer Inc VAT	RAL Colours Ex VAT	RAL Colours Inc VAT	Special Finishes Ex VAT	Special Finishes Inc VAT
DELIVERY TIMES		5-7 WORKING DAYS		UP TO 3 WEEKS		UP TO 3 WEEKS	
PPLEDBCFKIT2	2	£49.00	£58.80	£79.38	£95.26	£107.80	£129.36
PPLEDBCFKIT3	3	£77.00	£92.40	£124.74	£149.69	£169.40	£203.28
PPLEDBCFKIT4	4	£103.00	£123.60	£166.86	£200.23	£226.60	£271.92

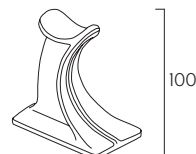

Please specify finish at time of order

If you require additional cast feet or wall ties please see pricing table below and specify at time of order

Description	Model	Primer Ex VAT	Primer Inc VAT	RAL Colours Ex VAT	RAL Colours Inc VAT	Special Finishes Ex VAT	Special Finishes Inc VAT
DELIVERY TIMES		5-7 WORKING DAYS		UP TO 3 WEEKS		UP TO 3 WEEKS	
Cast foot (each)	PPCIFM01	£22.00	£26.40	£38.06	£45.67	£49.94	£59.93
Wall tie (each)	PPCIWT01	£4.00	£4.80	N/A	N/A	N/A	N/A

Please remember to add 100mm to the height of the Ledbury section you have chosen if you are using cast feet.

## Solid Brass Cast Iron Wall Ties & Airvents New

These solid brass wall ties provide a stylish finishing touch to any cast iron radiator; select to match your valves. Available as a kit including matching airvent in Antique Brass, Chrome, Polished Brass and Brushed Nickel. Please note that these wall ties and airvents are an optional extra and do not come as standard with your cast iron radiator.

Description	Model	Number of Wall Ties	Number of Airvents	Price Ex VAT	Price Inc VAT
DELIVERY TIMES		48-72 HOURS			
Single Wall Tie	PPCIWT	1	N/A	£64.00	£76.80
Single Airvent	PPLAV	N/A	1	£12.00	£14.40
Wall Tie & Airvent Kit	PPCIWTAVKIT2	2	1	£134.00	£160.80
Wall Tie & Airvent Kit	PPCIWTAVKIT3	3	1	£192.00	£230.40
Wall Tie & Airvent Kit	PPCIWTAVKIT4	4	1	£252.00	£302.40
Wall Tie & Airvent Kit	PPCIWTAVKIT5	5	1	£312.00	£374.40

Antique Brass



Chrome



Polished Brass

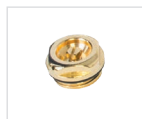

Brushed Nickel

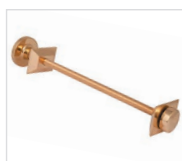

Please specify finish at time of order



Cast Iron; Mounting options include cast feet, footed ends (selected sizes) or wall brackets. CE/UKCA approved & certified to BS EN442.

Supplied in a standard primer, ready to be painted in your desired finish 24 RAL colours (shown on page 197) and 29 special finishes.

Please call **01342 302250** for a RAL or Special Finish chart  
Colour Coordination Service available, see pages 6-7 for full details.

**Stock Primer: 5-7 working days.** RAL colours & special finishes: up to 5 weeks.  
Please add 10 working days for orders of more than 10 radiators



**SAVE £45** WHEN YOU BUY OUR **VINTAGE TRV KIT** WITH ANY CAST IRON ORDER\*  
QUOTING **PROMOV2** AT TIME OF ORDER

For all Vintage TRV finishes

## Telford Sectional options with footed end sections

Build your radiator to fit your requirements using individual sections shown below, visit page 188 to help you size your radiator. If you require more than 40 sections please contact our Customer Services team on 01342 302250.

### 2 Column

Height A (mm)	Width B (mm)	Model	Watts Δt 50°C	Btu's Δt 50°C	Primer Ex VAT	Primer Inc VAT	RAL Colours Ex VAT	RAL Colours Inc VAT	Special Finishes Ex VAT	Special Finishes Inc VAT
DELIVERY TIMES					5-7 WORKING DAYS		UP TO 5 WEEKS		UP TO 5 WEEKS	
485	60	TELF2C43FS	43	147	£24.64	£29.57	£40.66	£48.79	£50.51	£60.61
735	60	TELF2C68FS	63	215	£34.70	£41.64	£57.26	£68.71	£71.14	£85.37
1035	60	TELF2C98FS	86	293	£44.76	£53.71	£73.85	£88.62	£91.76	£110.11

Please specify your finish at time of order, lead times vary for different finishes so please see information on delivery.

Telford	Pipe centres left to right	Pipe centres from wall
2 Column	60 x number of sections + 30mm bushes + valves	85mm to 105mm
4 Column	60 x number of sections + 30mm bushes + valves	130mm to 150mm
6 Column	60 x number of sections + 30mm bushes + valves	175mm to 195mm

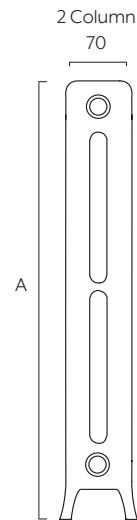

**Telford Sectional options** please see opposite for floor mounting options, wall brackets are available on request, please call customer services on 01342 302250 for more information and prices

Build your radiator to fit your requirements using individual sections shown below, visit page 188 to help you size your radiator. If you require more than 40 sections please contact our Customer Services team on 01342 302250.

### 2 Column

Height A (mm)	Width B (mm)	Model	Watts Δt 50°C	Btu's Δt 50°C	Primer Ex VAT	Primer Inc VAT	RAL Colours Ex VAT	RAL Colours Inc VAT	Special Finishes Ex VAT	Special Finishes Inc VAT
DELIVERY TIMES					5-7 WORKING DAYS		UP TO 5 WEEKS		UP TO 5 WEEKS	
430	60	TELF2C43	43	147	£24.64	£29.57	£40.66	£48.79	£50.51	£60.61
680	60	TELF2C68	63	215	£34.70	£41.64	£57.26	£68.71	£71.14	£85.37
980	60	TELF2C98	86	293	£44.76	£53.71	£73.85	£88.62	£91.76	£110.11

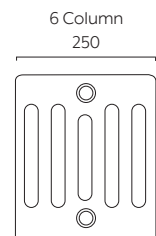
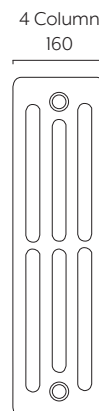
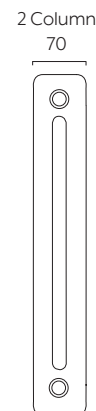

### 4 Column

Height A (mm)	Width B (mm)	Model	Watts Δt 50°C	Btu's Δt 50°C	Primer Ex VAT	Primer Inc VAT	RAL Colours Ex VAT	RAL Colours Inc VAT	Special Finishes Ex VAT	Special Finishes Inc VAT
DELIVERY TIMES					5-7 WORKING DAYS		UP TO 5 WEEKS		UP TO 5 WEEKS	
580	60	TELF4C58	96	328	£52.85	£63.42	£87.20	£104.64	£108.34	£130.01

### 6 Column

Height A (mm)	Width B (mm)	Model	Watts Δt 50°C	Btu's Δt 50°C	Primer Ex VAT	Primer Inc VAT	RAL Colours Ex VAT	RAL Colours Inc VAT	Special Finishes Ex VAT	Special Finishes Inc VAT
DELIVERY TIMES					5-7 WORKING DAYS		UP TO 5 WEEKS		UP TO 5 WEEKS	
280	60	TELF6C28	72	246	£43.13	£51.76	£71.16	£85.39	£88.42	£106.10

\*Saving based on the value of individual items when bought separately. Order any of our selected valves & matching pipe covers at the same time as your radiator.

# Optional Cast iron cast feet for Telford

If you require optional Cast Feet please specify at time of order by adding the relevant kit and price below. Wall Brackets are also available on request, please call 01342 302250 to discuss with our customer service team.

Up to 20 Sections	21 - 39 Sections (odd number of sections)	22 - 40 Sections (even number of sections)
2 Feet - 1 at each end	3 Feet - 1 at each end and 1 positioned centrally	4 Feet - 1 at each end and 2 spaced equally inbetween
2 Wall Ties	3 Wall Ties	4 Wall Ties

Wall Ties are included in the price and supplied as standard for all orders. Please specify your chosen mounting option at time of order.

Model	Number of Feet	Primer Ex VAT	Primer Inc VAT	RAL Colours Ex VAT	RAL Colours Inc VAT	Special Finishes Ex VAT	Special Finishes Inc VAT
DELIVERY TIMES		5-7 WORKING DAYS		UP TO 5 WEEKS		UP TO 5 WEEKS	
PPTELFCKKIT2	2	£49.00	£58.80	£79.38	£95.26	£107.80	£129.36
PPTELFCKKIT3	3	£77.00	£92.40	£124.74	£149.69	£169.40	£203.28
PPTELFCKKIT4	4	£103.00	£123.60	£166.86	£200.23	£226.60	£271.92

Please specify finish at time of order

If you require additional cast feet or wall ties please see pricing table below and specify at time of order

Description	Model	Primer Ex VAT	Primer Inc VAT	RAL Colours Ex VAT	RAL Colours Inc VAT	Special Finishes Ex VAT	Special Finishes Inc VAT
DELIVERY TIMES		5-7 WORKING DAYS		UP TO 5 WEEKS		UP TO 5 WEEKS	
Cast foot (each)	PPANSFM01	£22.00	£26.40	£38.06	£45.67	£49.94	£59.93
Wall tie (each)	PPCIWT01	£4.00	£4.80	N/A	N/A	N/A	N/A

Please remember to add 100mm to the height of the Telford section you have chosen if you are using Cast Feet.

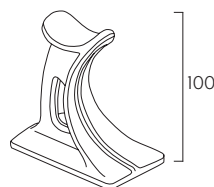

## Solid Brass Cast Iron Wall Ties & Airvents New

These solid brass wall ties provide a stylish finishing touch to any cast iron radiator; select to match your valves. Available as a kit including matching airvent in Antique Brass, Chrome, Polished Brass and Brushed Nickel. Please note that these wall ties and airvents are an optional extra and do not come as standard with your cast iron radiator.

Description	Model	Number of Wall Ties	Number of Airvents	Price Ex VAT	Price Inc VAT
DELIVERY TIMES				48-72 HOURS	
Single Wall Tie	PPCIWT	1	N/A	£64.00	£76.80
Single Airvent	PPLAV	N/A	1	£12.00	£14.40
Wall Tie & Airvent Kit	PPCIWTAVKIT2	2	1	£134.00	£160.80
Wall Tie & Airvent Kit	PPCIWTAVKIT3	3	1	£192.00	£230.40
Wall Tie & Airvent Kit	PPCIWTAVKIT4	4	1	£252.00	£302.40
Wall Tie & Airvent Kit	PPCIWTAVKIT5	5	1	£312.00	£374.40

Antique Brass

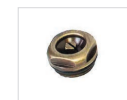

Chrome



Polished Brass

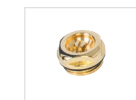

Brushed Nickel

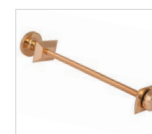
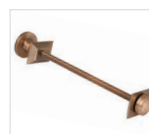

Please specify finish at time of order

## Joining Keys

Cast iron radiators come assembled up to a maximum of 10 sections. Radiators larger than these will require on-site assembly using a Joining Key.

- The Heavy Duty Joining Key is available on a sale or return basis.** Joining Keys must be specified at time of order for assistance please contact our Customer Service team on 01342 302250, they will also arrange a courier to collect it from you when you are ready.

Description	Model	Price Ex VAT	Price Inc VAT
DELIVERY TIMES			
48-72 HOURS			
Heavy duty joining tool	PPASMT5	£506.00	£607.20

Heavy Duty Joining Tool (includes tommy bar) engineered in the UK



# Linton shown on pages 82-83

Cast Iron; 2 or 3 column footed ends only  
CE/UKCA approved & certified to BS EN442.

24 RAL colours (shown on page 197), 4 special finishes, Polished & Burnished finishes plus 1 Galvanised finish (details below).  
Please call **01342 302250** for a RAL chart.

Made to order: RAL colours, Soft Gold, Slate Grey, Flat Black up to 5 weeks.  
Antique Brass, Burnished, Galvanised Copper & Polished up to 7 weeks.  
Please add 10 working days for orders of more than 10 radiators.



**SAVE £45** WHEN YOU BUY OUR **VINTAGE TRV KIT** WITH ANY CAST IRON ORDER\*  
QUOTING **PROMOV2** AT TIME OF ORDER

For all Vintage TRV finishes

## Linton Sectional options

Free standing with footed ends only

### RAL & Special Finishes (Soft Gold, Slate Grey, Flat Black)

2 Column

Height A (mm)	Width B (mm)	Model	Watts Δt 50°C	Btu's Δt 50°C	RAL Colours Ex VAT	RAL Colours Inc VAT	Special Finishes Ex VAT	Special Finishes Inc VAT
DELIVERY TIMES			UP TO 5 WEEKS		UP TO 5 WEEKS			
521	82	LINT2C521	86	293	£129.67	£155.60	£139.19	£167.03
621	82	LINT2C621	103	351	£147.52	£177.02	£160.60	£192.72
721	82	LINT2C721	124	423	£152.27	£182.72	£168.93	£202.72
921	82	LINT2C921	161	549	£182.02	£218.42	£191.53	£229.84

3 Column

Height A (mm)	Width B (mm)	Model	Watts Δt 50°C	Btu's Δt 50°C	RAL Colours Ex VAT	RAL Colours Inc VAT	Special Finishes Ex VAT	Special Finishes Inc VAT
DELIVERY TIMES			UP TO 5 WEEKS		UP TO 5 WEEKS			
621	82	LINT3C621	119	406	£176.07	£211.28	£182.02	£218.42
721	82	LINT3C721	138	471	£183.21	£219.85	£214.14	£256.97
921	82	LINT3C921	176	601	£221.28	£265.54	£249.83	£299.80



Soft Gold

Slate Grey

Flat Black

Please specify your finish at time of order, delivery time is 5 weeks

### Burnished & Polished Finishes

2 Column

Height A (mm)	Width B (mm)	Model	Watts Δt 50°C	Btu's Δt 50°C	Burnished Ex VAT	Burnished Inc VAT	Polished Ex VAT	Polished Inc VAT
DELIVERY TIMES			UP TO 7 WEEKS		UP TO 7 WEEKS			
521	82	LINT2C521	86	293	£146.32	£175.58	£151.09	£181.31
621	82	LINT2C621	103	351	£170.12	£204.14	£177.25	£212.70
721	82	LINT2C721	124	423	£178.45	£214.14	£199.86	£239.83
921	82	LINT2C921	161	549	£212.95	£255.54	£253.40	£304.08

3 Column

Height A (mm)	Width B (mm)	Model	Watts Δt 50°C	Btu's Δt 50°C	Burnished Ex VAT	Burnished Inc VAT	Polished Ex VAT	Polished Inc VAT
DELIVERY TIMES			UP TO 7 WEEKS		UP TO 7 WEEKS			
621	82	LINT3C621	119	406	£193.91	£232.69	£235.55	£282.66
721	82	LINT3C721	138	471	£229.60	£275.52	£279.57	£335.48
921	82	LINT3C921	176	601	£266.49	£319.79	£321.21	£385.45



Burnished

Polished

Please specify your finish at time of order, delivery time is 7 weeks for Burnished and 7 weeks for Polished.

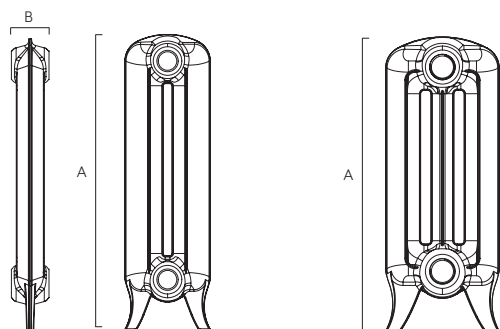

Linton	Pipe centres left to right	Pipe centres from wall	Depth from wall
2 Column	82 x number of sections + 32mm + valves	120mm	210mm
3 Column	82 x number of sections + 32mm + valves	130mm	230mm

\*Saving based on the value of individual items when bought separately. Order any of our selected valves & matching pipe covers at the same time as your radiator.



## Antique Brass & Galvanised Finish Antique Copper

If selecting Antique Brass please read the below about the finish.

### 2 Column

Height A (mm)	Width B (mm)	Model	Watts $\Delta t$ 50°C	Btu's $\Delta t$ 50°C	Antique Brass Ex VAT	Antique Brass Inc VAT	Galvanic Copper Ex VAT	Galvanic Copper Inc VAT
DELIVERY TIMES					UP TO 7 WEEKS		UP TO 7 WEEKS	
521	82	LINT2C521	86	293	£201.05	£241.26	£216.51	£259.81
621	82	LINT2C621	103	351	£215.33	£258.40	£239.12	£286.94
721	82	LINT2C721	124	423	£230.79	£276.95	£255.77	£306.92
921	82	LINT2C921	161	549	£268.86	£322.63	£316.45	£379.74

### 3 Column

Height A (mm)	Width B (mm)	Model	Watts $\Delta t$ 50°C	Btu's $\Delta t$ 50°C	Antique Brass Ex VAT	Antique Brass Inc VAT	Galvanic Copper Ex VAT	Galvanic Copper Inc VAT
DELIVERY TIMES					UP TO 7 WEEKS		UP TO 7 WEEKS	
621	82	LINT3C621	119	406	£242.69	£291.23	£267.67	£321.20
721	82	LINT3C721	138	471	£280.75	£336.90	£316.45	£379.74
921	82	LINT3C921	176	601	£330.73	£396.88	£389.02	£466.82

Please specify your finish at time of order, delivery time is 7 weeks for Antique Brass and Galvanised Antique Copper.



Galvanised Copper

Antique Brass

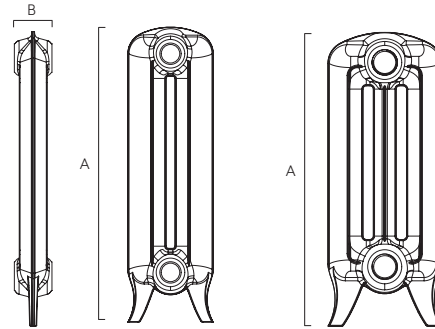

Linton	Pipe centres left to right	Pipe centres from wall	Depth from wall
2 Column	82 x number of sections + 32mm + valves	120mm	210mm
3 Column	82 x number of sections + 32mm + valves	130mm	230mm

## Antique Brass Finish

Cast iron is a classic favourite, loved for its traditional qualities and style. Part of the charm of cast iron is the inherent imperfections and idiosyncrasies in the metal produced by the traditional production methods. Newly cast product retains the texture and individuality of radiators cast over 100 years ago, but in order to create an aged appearance to the finish, they go through a number of stages ending with a hand-finished application. The appeal of an antique product is its unique patina developed over time, each radiator will differ, and so to reproduce that effect our Antique finishes will have a varying depth of light and dark across the radiator.

After cleaning, priming and the application of the brass effect powder coat each radiator has an antique rub applied by hand. This is then rubbed down and baked to fix the protective surface. The level and amount of light and dark differ from section to section as the combination of texture, casting marks and the random nature of hand finishing produces a striking and unique antiqued finish.

Casting marks and textures retain the antique topcoat, highlighting the natural surface texture of the cast metal



Darker areas occur when hard to access areas and mould patterns retain more of the antique rub, creating an individual final finish.

# Trieste

shown on pages 84-85



Cast Iron; 2 or 3 column footed ends only  
CE/UKCA approved & certified to BS EN442.

Supplied in a standard primer, ready to be painted in your desired finish  
24 RAL colours (shown on page 197) and 29 special finishes.  
Please call **01342 302250** for a RAL or Special Finish chart  
Colour Coordination Service available, see pages 6-7 for full details.

**Stock Primer: 5-7 working days.** RAL colours & special finishes: up to 3 weeks.  
Please add 10 working days for orders of more than 10 radiators



**SAVE £45** WHEN YOU BUY OUR **VINTAGE TRV KIT** WITH ANY CAST IRON ORDER\*  
QUOTING **PROMOV2** AT TIME OF ORDER

For all Vintage TRV finishes

## Trieste sectional options with footed end sections

Build your radiator to fit your requirements using individual sections shown below, visit page 188 to help you size your radiator. If you require more than 40 sections please contact our Customer Services team on 01342 302250.

### 2 Column

Height A (mm)	Width B (mm)	Model	Watts Δt 50°C	Btu's Δt 50°C	Primer Ex VAT	Primer Inc VAT	RAL Colours Ex VAT	RAL Colours Inc VAT	Special Finishes Ex VAT	Special Finishes Inc VAT
DELIVERY TIMES					5-7 WORKING DAYS		UP TO 3 WEEKS		UP TO 3 WEEKS	
661	76	NTRIE2C66	130	444	£104.34	£125.21	£151.29	£181.55	£164.86	£197.83
760	76	NTRIE2C76	143	488	£113.99	£136.79	£165.29	£198.35	£180.10	£216.12
955	76	NTRIE2C95	168	573	£150.89	£181.07	£218.79	£262.55	£238.41	£286.09

### 2 Column Mini Trieste

Height A (mm)	Width B (mm)	Model	Watts Δt 50°C	Btu's Δt 50°C	Primer Ex VAT	Primer Inc VAT	RAL Colours Ex VAT	RAL Colours Inc VAT	Special Finishes Ex VAT	Special Finishes Inc VAT
DELIVERY TIMES					5-7 WORKING DAYS		UP TO 3 WEEKS		UP TO 3 WEEKS	
514	76	NMINTRIE2C51	110	375	£69.02	£82.82	£100.08	£120.10	£109.05	£130.86

### 3 Column

Height A (mm)	Width B (mm)	Model	Watts Δt 50°C	Btu's Δt 50°C	Primer Ex VAT	Primer Inc VAT	RAL Colours Ex VAT	RAL Colours Inc VAT	Special Finishes Ex VAT	Special Finishes Inc VAT
DELIVERY TIMES					5-7 WORKING DAYS		UP TO 3 WEEKS		UP TO 3 WEEKS	
768	78	NTRIE3C76	189	645	£118.81	£142.57	£172.27	£206.72	£187.72	£225.26
961	78	NTRIE3C96	221	754	£157.32	£188.78	£228.11	£273.73	£248.57	£298.28

The Trieste is a free standing radiator and is supplied with footed end sections only.

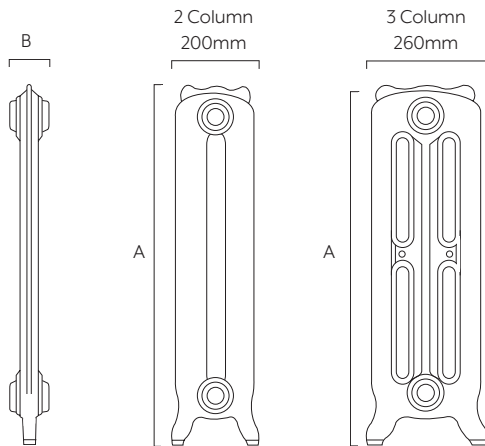

Trieste	Pipe centres left to right	Pipe centres from wall
2 Column	76 x number of sections + 24mm bushes + valves	As a free standing radiator, pipe centres depend on final position.
3 Column	78 x number of sections + 24mm bushes + valves	As a free standing radiator, pipe centres depend on final position.

\*Saving based on the value of individual items when bought separately. Order any of our selected valves & matching pipe covers at the same time as your radiator.

Some of the 29 Special Finishes the Trieste is available in, please call **01342 302250** for our special finish chart



# Bohemia shown on pages 86-87

Cast Iron; 2 column footed ends only  
CE/UKCA approved & certified to BS EN442.

24 RAL colours (shown on page 197), 4 special finishes, Burnished finish plus 1 Galvanised finish (details below).  
Please call **01342 302250** for a RAL chart

Made to order: RAL colours, Soft Gold, Slate Grey, Flat Black up to 5 weeks.  
Burnished, Antique Brass and Galvanised Copper up to 7 weeks.  
Please add 10 working days for orders of more than 10 radiators



**SAVE £45** WHEN YOU BUY OUR **VINTAGE TRV KIT** WITH ANY CAST IRON ORDER\*  
QUOTING **PROMOV2** AT TIME OF ORDER

For all Vintage TRV finishes

## Bohemia Sectional options

2 column free standing with footed ends only

### RAL & Special Finishes (Soft Gold, Slate Grey, Flat Black)

Height A (mm)	Width B (mm)	Model	Watts Δt 50°C	Btu's Δt 50°C	RAL Colours Ex VAT	RAL Colours Inc VAT	Special Finishes Ex VAT	Special Finishes Inc VAT
DELIVERY TIMES					UP TO 5 WEEKS		UP TO 5 WEEKS	
520	82	BOHE2C520	86	293	£147.34	£176.81	£154.86	£185.83
720	82	BOHE2C720	120	409	£202.16	£242.59	£211.76	£254.11
920	82	BOHE2C920	149	508	£252.45	£302.94	£264.89	£317.87



Soft Gold

Slate Grey

Flat Black

Please specify your finish at time of order, delivery time is 5 weeks

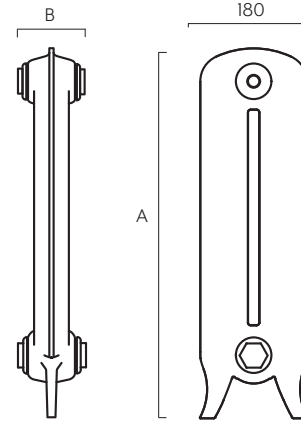

Pipe centres left to right	Pipe centres from wall	Depth from wall
82 x number of sections + 32mm + valves	120mm	210mm

### Burnished Finish

Height A (mm)	Width B (mm)	Model	Watts Δt 50°C	Btu's Δt 50°C	Burnished Ex VAT	Burnished Inc VAT
DELIVERY TIMES					UP TO 7 WEEKS	
520	82	BOHE2C520	86	293	£162.15	£194.58
720	82	BOHE2C720	120	409	£224.13	£268.96
920	82	BOHE2C920	149	508	£277.29	£332.75

Please specify your finish at time of order, delivery time is 7 weeks



Burnished

### Antique Brass & Galvanised Finish Antique Copper

Height A (mm)	Width B (mm)	Model	Watts Δt 50°C	Btu's Δt 50°C	Antique Brass Ex VAT	Antique Brass Inc VAT	Galvanic Copper Ex VAT	Galvanic Copper Inc VAT
DELIVERY TIMES					UP TO 7 WEEKS		UP TO 7 WEEKS	
520	82	BOHE2C520	86	293	£225.10	£270.12	£226.25	£271.50
720	82	BOHE2C720	120	409	£278.73	£334.48	£309.46	£371.35
920	82	BOHE2C920	149	508	£309.71	£371.65	£389.73	£467.68



Galvanised Copper

Please specify your finish at time of order, delivery time is 7 weeks for Antique Brass, 7 weeks for Galvanised Antique Copper.



### Antique Brass (see page 193 for more details)

Cast iron is a classic favourite, loved for its traditional qualities and style. Part of the charm of cast iron is the inherent imperfections and idiosyncrasies in the metal produced by the traditional production methods. Newly cast product retains the texture and individuality of radiators cast over 100 years ago, but in order to create an aged appearance to the finish, they go through a number of stages ending with a hand-finished application. The appeal of an antique product is its unique patina developed over time, each radiator will differ and so to reproduce that effect our Antique finishes will have a varying depth of light and dark across the radiator. After cleaning, priming and the application of the brass effect powder coat each radiator has an antique rub applied by hand. This is then rubbed down and baked to fix the protective surface. The level and amount of light and dark differ from section to section as the combination of texture, casting marks and the random nature of hand finishing produces a striking and unique antiqued finish.

\*Saving based on the value of individual items when bought separately. Order any of our selected valves & matching pipe covers at the same time as your radiator.

# Colour Coordination New

We understand that many interior designs can be enhanced with carefully applied colour coordination or contrasts to create a standout feature. Today we have a huge choice of brands and exciting colour palettes and tones to choose from for our walls and woodwork, providing the opportunity to create truly stunning rooms. If you are looking to create a uniquely personal look using colours from either popular or premium paint brands, we can take your chosen colour and create a highly durable powder coat finish that will allow your radiator to blend in with your wall colour, or stand out if you want to make a statement!



Sitar radiator colour coordinated to Farrow & Ball® paint Citron 74

Making sure that you get something that reflects the effort you have taken in choosing your colours is important. Once we know the radiators you are interested in and the make, name and code of your chosen colour, we can supply a quote and an estimate of delivery times. **Please note that sometimes we will require a physical sample to colour match from.**

The first step is to order a colour sample, for which a small charge of £120 Inc VAT will apply (this will be deducted from the full order when placed). We will then mix a batch of powder and prepare a sample for you to check and approve. Once you are happy, you can proceed to order your radiators.

To achieve your desired colour and allow for the sample and final production, we have an extension on our standard delivery times to allow for the process, this could be up to 6 weeks for the sample, and once the sample has been approved, up to 8 weeks for the completion of your radiator order. Timescales will be determined by the size and quantity of radiators you require, we will be able to provide a more accurate estimation when we quote for your project.

Please see page 7 for our step by step guide and further information.



The colour coordination icon indicates which products are available for this service and are shown on the relevant technical pages. Please call us on **01342 302250** or visit **theradiatorcompany.co.uk** for more information.



Ledbury radiator colour coordinated to Benjamin Moore paint Van Deusen Blue (HC-156)



Ancona radiator with matching Pistol TRV's, pipe covers and shrouds colour coordinated to Benjamin Moore paint Aegean Teal (2136-40)

# 23 RAL Colours

For Sectional Aluminium, Cast Iron, Torr , Canto, Iseo, Niro, Poppy & Lupin ranges

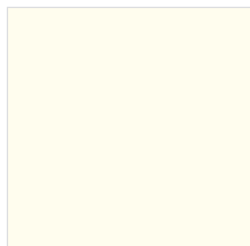

RAL 9010 - Pure white

Supplied as standard for Aluminium (Vip, Oscar, Mix & Vox)

Optional RAL Colour for all Cast Iron including the Linton Towel Rail, plus the Torr , Canto, Iseo, Niro and Poppy & Lupin ranges.



RAL 1001 - Beige

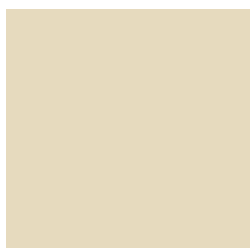

RAL 1013 - Oyster white



RAL 1015 - Light ivory



RAL 1019 - Grey beige



RAL 3000 - Flame red



RAL 3003 - Ruby red

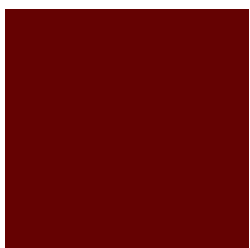

RAL 3004 - Purple red



RAL 4003 - Heather violet



RAL 5024 - Pastel blue



RAL 6006 - Grey olive



RAL 6013 - Reed green



RAL 7016 - Anthracite grey



RAL 7032 - Pebble grey



RAL 7035 - Light grey



RAL 7040 - Window grey



RAL 7042 - Traffic grey A



RAL 7044 - Silk grey

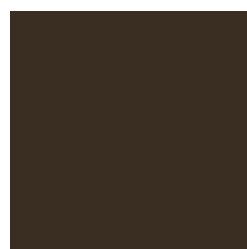

RAL 8011 - Nut brown

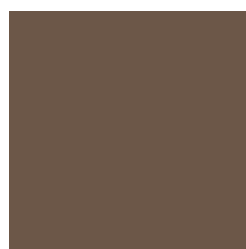

RAL 8025 - Pale brown

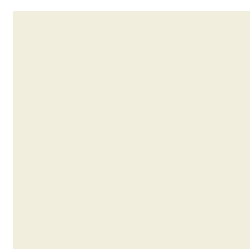

RAL 9001 - Cream

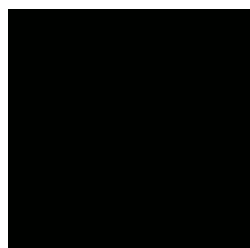

RAL 9004 - Signal black

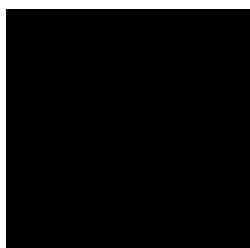

RAL 9005 - Jet black

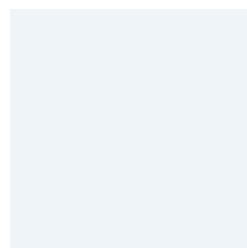

RAL 9016 - Traffic white

**Please Note:**

Due to printing processes and manufacturing tolerances, the colour of finished radiators may vary slightly from those colours shown on this page.

Please call **01342 302250** for a RAL chart.

# Step BDO shown on page 90



reddot award 2014  
winner



High quality Italian design & manufacture

Aluminium; horizontal towel rail

10 year guarantee, CE/UKCA approved & certified to BS EN442.

White Pearl & Chrome

Made to Order:

Up to 5 weeks: White Pearl & Chrome



**SAVE £45** WHEN YOU BUY OUR **CYLINDER KIT** WITH ANY TOWEL RAIL ORDER\*  
QUOTE **PROMOV3** AT TIME OF ORDER

Available in White or Chrome

Pipe centres left to right	Pipe centres from wall	Depth from wall
width - 224mm	60mm - 67mm	107mm - 114mm

Made to order options - White Pearl

Height (mm)	Width (mm)	Model	Watts Δt 50°C	Btu's Δt 50°C	White Pearl Ex VAT	White Pearl Inc VAT
DELIVERY TIMES			UP TO 5 WEEKS			
310	1500	STEBDO3115WP	466	1590	£1,332.00	£1,598.40
	1800	STEBDO3118WP	559	1907	£1,360.00	£1,632.00
430	1500	STEBDO4315WP	624	2129	£1,588.00	£1,905.60
	1800	STEBDO4318WP	749	2556	£1,797.00	£2,156.40

107-114



60-67



Made to order options - Chrome

Height (mm)	Width (mm)	Model	Watts Δt 50°C	Btu's Δt 50°C	Chrome Ex VAT	Chrome Inc VAT
DELIVERY TIMES			UP TO 5 WEEKS			
310	1500	STEBDO3115	326	1112	£1,491.00	£1,789.20
	1800	STEBDO3118	391	1334	£1,732.00	£2,078.40
430	1500	STEBDO4315	436	1488	£1,836.00	£2,203.20
	1800	STEBDO4318	524	1788	£2,374.00	£2,848.80



Chrome

\*Saving based on the value of individual items when bought separately. Order any of our selected valves & matching pipe covers at the same time as your radiator; PROMOV3W (white), PROMOV3C (chrome).

# Step shown on page 91



red dot award 2014 winner



High quality Italian design & manufacture  
Aluminium; vertical ladder rail. Hydronic & Electric models  
10 year guarantee, CE/UKCA approved & certified to BS EN442.

White Pearl & Chrome

Made to Order:

Up to 5 weeks: White Pearl & Chrome

Up to 5 weeks for White Pearl electric, 7 weeks for Chrome



**SAVE £45** WHEN YOU BUY OUR **CYLINDER KIT** WITH ANY TOWEL RAIL ORDER\* QUOTE **PROMOV3** AT TIME OF ORDER

Available in White or Chrome

Pipe centres left to right	Pipe centres from wall	Depth from wall
width - 224mm	60mm - 67mm	107mm - 114mm

Made to order options - White Pearl



Height (mm)	Width (mm)	Model	Watts Δt 50°C	Btu's Δt 50°C	White Pearl Ex VAT	White Pearl Inc VAT
DELIVERY TIMES			UP TO 5 WEEKS			
760	500	STEP7650WP	370	1262	£1,625.00	£1,950.00
	600	STEP7660WP	421	1436	£1,646.00	£1,975.20
1240	500	STEP1250WP	598	2040	£2,235.00	£2,682.00
	600	STEP1260WP	653	2228	£2,254.00	£2,704.80
1720	500	STEP1750WP	816	2784	£2,829.00	£3,394.80
	600	STEP1760WP	935	3190	£2,873.00	£3,447.60

107-114 [ ] 60-67

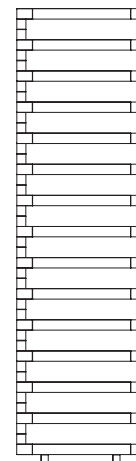
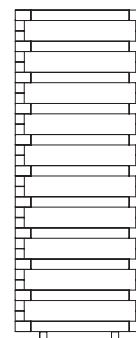
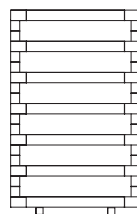

Made to order options - Chrome



Height (mm)	Width (mm)	Model	Watts Δt 50°C	Btu's Δt 50°C	Chrome Ex VAT	Chrome Inc VAT
DELIVERY TIMES			UP TO 5 WEEKS			
760	500	STEP7650	273	931	£1,756.00	£2,107.20
	600	STEP7660	304	1037	£1,807.00	£2,168.40
1240	500	STEP1250	404	1378	£2,481.00	£2,977.20
	600	STEP1260	472	1610	£2,565.00	£3,078.00
1720	500	STEP1750	577	1969	£3,213.00	£3,855.60
	600	STEP1760	653	2228	£3,323.00	£3,987.60

Made to order options - Electric

Height (mm)	Width (mm)	Model	Watts Δt 50°C	White Pearl Ex VAT	White Pearl Inc VAT	Chrome Ex VAT	Chrome Inc VAT
DELIVERY TIMES			UP TO 5 WEEKS		UP TO 7 WEEKS		
775	500	STEP7750E	250	£1,955.00	£2,346.00	£2,815.00	£3,378.00
1255	500	STEP1250E	450	£2,529.00	£3,034.80	£3,871.00	£4,645.20
1735	500	STEP1750E	650	£3,115.00	£3,738.00	£4,939.00	£5,926.80

The Step Electric has a number of functions that gives you complete control. You can set the desired temperature in adjustments from 7°C to 31°C, there is a boost facility that delivers maximum power for 2 hours. It also has infrared capabilities for weekly programming, comfort and night-time modes, via remote control.



\*Saving based on the value of individual items when bought separately. Order any of our selected valves & matching pipe covers at the same time as your radiator; PROMOV3W (white), PROMOV3C (chrome).

# Athena BDO shown on page 92

Steel; Slimline horizontal towel rail  
CE/UKCA approved & certified to BS EN442.

White RAL 9016 as standard, 188 RAL Colours and 30 Special Finishes  
Please call **01342 302250** for a RAL or Special Finish chart.

## Stock White RAL 9016: 48-72 Hours

Made to Order sizes & colours: Up to 7 weeks for White.  
Up to 8 weeks for colours.

### Stock options White RAL 9016

Height (mm)	Width (mm)	Model	Watts Δt 50°C	Btu's Δt 50°C	White Ex VAT	White Inc VAT	Colours Ex VAT	Colours Inc VAT
DELIVERY TIMES					48-72 HOURS		UP TO 8 WEEKS	
370	1200	ATHEBDO3712	444	1515	£547.00	£656.40	£683.75	£820.50
455	1200	ATHEBDO4512	539	1839	£581.00	£697.20	£726.25	£871.50
	1500	ATHEBDO4515	647	2208	£628.00	£753.60	£785.00	£942.00
540	1200	ATHEBDO5412	617	2105	£614.00	£736.80	£767.50	£921.00
	1500	ATHEBDO5415	736	2511	£667.00	£800.40	£833.75	£1,000.50

Made to order options

Height (mm)	Width (mm)	Model	Watts Δt 50°C	Btu's Δt 50°C	White Ex VAT	White Inc VAT	Colours Ex VAT	Colours Inc VAT
DELIVERY TIMES					UP TO 7 WEEKS		UP TO 8 WEEKS	
370	1000	ATHEBDO3710	355	1211	£517.00	£620.40	£646.25	£775.50
	1500	ATHEBDO3715	534	1822	£590.00	£708.00	£737.50	£885.00
455	1000	ATHEBDO4510	431	1471	£549.00	£658.80	£686.25	£823.50
540	1000	ATHEBDO5410	498	1699	£578.00	£693.60	£722.50	£867.00

\*Saving based on the value of individual items when bought separately. Order any of our selected valves & matching pipe covers at the same time as your radiator; PROMOV3W (white), PROMOV3C (chrome).



**SAVE £45** WHEN YOU BUY OUR **CYLINDER KIT** WITH ANY TOWEL RAIL ORDER\* QUOTE **PROMOV3** AT TIME OF ORDER

Available in White or Chrome

Pipe centres left to right	Pipe centres from wall	Depth from wall
width - 70mm	45mm to 53mm	67mm to 75mm

67-75  
45-53

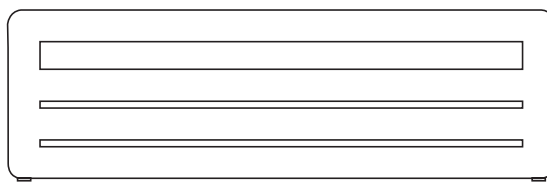

# Athena Towel Rail shown on page 93

Steel; Slimline towel rail  
CE/UKCA approved & certified to BS EN442.

White RAL 9016 as standard, 188 RAL Colours and 30 Special Finishes  
Please call **01342 302250** for a RAL or Special Finish chart.

## Stock White RAL 9016: 48-72 Hours

Made to Order sizes & colours: Up to 7 weeks for White.  
Up to 8 weeks for colours.

Pipe centres left to right	Pipe centres from wall	Depth from wall
width - 70mm	45mm to 53mm	67mm to 75mm

### Stock options White RAL 9016

Height (mm)	Width (mm)	Model	Watts Δt 50°C	Btu's Δt 50°C	White Ex VAT	White Inc VAT	Colours Ex VAT	Colours Inc VAT
DELIVERY TIMES					48-72 HOURS		UP TO 8 WEEKS	
920	500	ATHETRI9250	396	1351	£584.00	£700.80	£730.00	£876.00
1260	500	ATHETRI1250	532	1815	£689.00	£826.80	£861.25	£1,033.50

Made to order options

Height (mm)	Width (mm)	Model	Watts Δt 50°C	Btu's Δt 50°C	White Ex VAT	White Inc VAT	Colours Ex VAT	Colours Inc VAT
DELIVERY TIMES					UP TO 7 WEEKS		UP TO 8 WEEKS	
1600	500	ATHETRI1650	678	2313	£829.00	£994.80	£1,036.25	£1,243.50

\*Saving based on the value of individual items when bought separately. Order any of our selected valves & matching pipe covers at the same time as your radiator; PROMOV3W (white), PROMOV3C (chrome).



**SAVE £45** WHEN YOU BUY OUR **CYLINDER KIT** WITH ANY TOWEL RAIL ORDER\* QUOTE **PROMOV3** AT TIME OF ORDER

Available in White or Chrome

67-75  
45-53

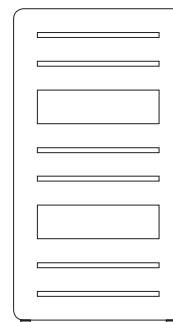



# Relax Bagno shown on page 94



High quality Italian design & manufacture  
Steel; round tube radiator with a steel flat cover, underneath connections only  
CE/UKCA approved & certified to BS EN442.

White RAL 9016 standard, 188 RAL Colours, 30 Special Finishes + Polished Stainless Steel.  
Please call **01342 302250** for a RAL or Special Finish chart

**Stock sizes: White RAL 9016 delivered in 48-72 hours,**  
Made to Order sizes & colours: Up to 5 weeks, Polished in up to 8 weeks



**SAVE £45** WHEN YOU BUY OUR **CYLINDER KIT** WITH ANY TOWEL RAIL ORDER\*  
QUOTE **PROMOV3** AT TIME OF ORDER

Available in White or Chrome

Single / Double	Pipe centres left to right	Pipe centres from wall	Depth from wall
Single	width - 109mm	55mm - 65mm	148mm - 158mm
Double	width - 109mm	79mm - 89mm	172mm - 182mm

## Stock options White RAL 9016 - Single

Height (mm)	Width (mm)	Model	Watts Δt 50°C	Btu's Δt 50°C	White Ex VAT	White Inc VAT	Colours Ex VAT	Colours Inc VAT
DELIVERY TIMES					48-72 HOURS		UP TO 5 WEEKS	
1853	517	RELBASV1851	1178	4019	<b>£1,688.00</b>	<b>£2,025.60</b>	£2,110.00	£2,532.00
	653	RELBASV1865	1519	5183	<b>£1,782.00</b>	<b>£2,138.40</b>	£2,227.50	£2,673.00

## Stock options White RAL 9016 - Double

Height (mm)	Width (mm)	Model	Watts Δt 50°C	Btu's Δt 50°C	White Ex VAT	White Inc VAT	Colours Ex VAT	Colours Inc VAT
DELIVERY TIMES					48-72 HOURS		UP TO 5 WEEKS	
1853	517	RELBADV1851	1477	5040	<b>£1,950.00</b>	<b>£2,340.00</b>	£2,437.50	£2,925.00
	653	RELBADV1865	1817	6200	<b>£2,235.00</b>	<b>£2,682.00</b>	£2,793.75	£3,352.50

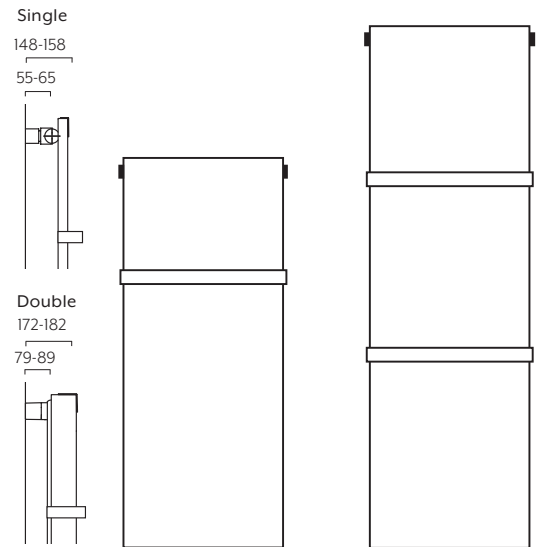

Please note: 1553mm high models have 1 chrome towel bar, 1853mm high models have 2 chrome bars.

Made to order options - Single white & colours

Height (mm)	Width (mm)	Model	Watts Δt 50°C	Btu's Δt 50°C	White Ex VAT	White Inc VAT	Colours Ex VAT	Colours Inc VAT
DELIVERY TIMES					UP TO 5 WEEKS		UP TO 5 WEEKS	
1553	381	RELBASV1538	699	2385	£1,080.00	£1,296.00	£1,350.00	£1,620.00
	517	RELBASV1551	984	3357	£1,182.00	£1,418.40	£1,477.50	£1,773.00
	653	RELBASV1565	1269	4330	£1,263.00	£1,515.60	£1,578.75	£1,894.50
1853	381	RELBASV1838	837	2856	£1,481.00	£1,777.20	£1,851.25	£2,221.50

Made to order options - Double white & colours

Height (mm)	Width (mm)	Model	Watts Δt 50°C	Btu's Δt 50°C	White Ex VAT	White Inc VAT	Colours Ex VAT	Colours Inc VAT
DELIVERY TIMES					UP TO 5 WEEKS		UP TO 5 WEEKS	
1553	381	RELBADV1538	1017	3470	£1,332.00	£1,598.40	£1,665.00	£1,998.00
	517	RELBADV1551	1431	4883	£1,426.00	£1,711.20	£1,782.50	£2,139.00
	653	RELBADV1565	1591	5428	£1,516.00	£1,819.20	£1,895.00	£2,274.00
1853	381	RELBADV1838	1050	3583	£1,743.00	£2,091.60	£2,178.75	£2,614.50

Made to order options - Single Polished Stainless Steel

Height (mm)	Width (mm)	Model	Watts Δt 50°C	Btu's Δt 50°C	Polished Stainless Steel Ex VAT	Polished Stainless Steel Inc VAT
DELIVERY TIMES					UP TO 8 WEEKS	
1553	381	RELBASV1538	489	1668	£2,388.00	£2,865.60
	517	RELBASV1551	689	2351	£2,522.00	£3,026.40
	653	RELBASV1565	888	3030	£2,616.00	£3,139.20
1853	381	RELBASV1838	586	1999	£3,104.00	£3,724.80
	517	RELBASV1851	825	2815	£3,336.00	£4,003.20
	653	RELBASV1865	1063	3627	£3,523.00	£4,227.60

Made to order options - Double Polished Stainless Steel

Height (mm)	Width (mm)	Model	Watts Δt 50°C	Btu's Δt 50°C	Polished Stainless Steel Ex VAT	Polished Stainless Steel Inc VAT
DELIVERY TIMES					UP TO 8 WEEKS	
1553	381	RELBADV1538	712	2429	£3,170.00	£3,804.00
	517	RELBADV1551	1002	3419	£3,268.00	£3,921.60
	653	RELBADV1565	1114	3801	£3,465.00	£4,158.00
1853	381	RELBADV1838	735	2508	£4,002.00	£4,802.40
	517	RELBADV1851	1034	3528	£4,297.00	£5,156.40
	653	RELBADV1865	1272	4340	£4,486.00	£5,383.20

\*Saving based on the value of individual items when bought separately. Order any of our selected valves & matching pipe covers at the same time as your radiator; PROMOV3W (white), PROMOV3C (chrome).

# Echo shown on page 95

Steel; Side loading towel rail, 50mm x 10mm flat tubes  
Can be installed left or right-handed  
CE/UKCA approved & certified to BS EN442.

White RAL 9016 as standard, 188 RAL Colours and 30 Special Finishes  
Please call **01342 302250** for a RAL or Special Finish chart.

## Stock White RAL 9016: 48-72 Hours

Made to Order sizes & colours: Up to 7 weeks White & White Electric,  
Up to 8 weeks Colours.

### Stock options White RAL 9016- Hydronic

Height (mm)	Width (mm)	Model	Watts Δt 50°C	Btu's Δt 50°C	White Ex VAT	White Inc VAT	Colours Ex VAT	Colours Inc VAT
DELIVERY TIMES					48-72 HOURS		UP TO 8 WEEKS	
850	500	ECHO8550	585	1996	£496.00	£595.20	£620.00	£744.00
1110	500	ECHO1150	764	2607	£616.00	£739.20	£770.00	£924.00

Made to order options - Hydronic

Height (mm)	Width (mm)	Model	Watts Δt 50°C	Btu's Δt 50°C	White Ex VAT	White Inc VAT	Colours Ex VAT	Colours Inc VAT
DELIVERY TIMES					UP TO 7 WEEKS		UP TO 8 WEEKS	
655	500	ECHO6550	450	1535	£417.00	£500.40	£521.25	£625.50
	600	ECHO6560	506	1726	£434.00	£520.80	£542.50	£651.00
850	600	ECHO8560	655	2235	£518.00	£621.60	£647.50	£777.00
1110	600	ECHO1160	857	2924	£648.00	£777.60	£810.00	£972.00
1695	500	ECHO1650	1167	3982	£868.00	£1,041.60	£1,085.00	£1,302.00
	600	ECHO1660	1310	4470	£916.00	£1,099.20	£1,145.00	£1,374.00

\*Saving based on the value of individual items when bought separately. Order any of our selected valves & matching pipe covers at the same time as your radiator; PROMOV3W (white), PROMOV3C (chrome).



### Cylinder Valve Kit



**SAVE £45** WHEN YOU BUY OUR **CYLINDER KIT** WITH ANY TOWEL RAIL ORDER\* QUOTE **PROMOV3** AT TIME OF ORDER

Available in White or Chrome

### Pipe centres left to right

50mm

### Pipe centres from wall

57mm - 65mm

### Depth from wall

112mm - 120mm

Made to order options - Electric

Height (mm)	Width (mm)	Model	Watts Δt 50°C	White Ex VAT	White Inc VAT		
DELIVERY TIMES						UP TO 7 WEEKS	
850	500	ECHO8550EW	600	£640.00	£768.00		
	600	ECHO8560EW	600	£661.00	£793.20		
1110	500	ECHO1150EW	800	£754.00	£904.80		
	600	ECHO1160EW	800	£783.00	£939.60		
1695	500	ECHO1650EW	1200	£995.00	£1,194.00		
	600	ECHO1660EW	1200	£1,039.00	£1,246.80		

Supplied as standard with a MOA Element

- 5 heat settings from 30°C to 60°C regulating internal radiator temperature, denoted by 5 LEDs. No Timer.
- Compatible with external Timer as remembers settings when turned off
- 55mm diameter clock shaped face.
- 4x Buttons: Temperature +/-, Dryer, Power. Frost & overheating protection.
- Straight cable, no plug. IPx5. Class I. Guarantee - 2 years.

# Piano Lato shown on page 97

High quality Italian design & manufacture  
Steel; side loading towel rail  
CE/UKCA approved & certified to BS EN442.

White RAL 9016 as standard, 188 RAL Colours and 30 Special Finishes  
Please call **01342 302250** for a RAL or Special Finish chart.

## Stock White RAL 9016: 48-72 Hours

Made to Order sizes & colours: Up to 5 weeks.



### Cylinder Valve Kit



**SAVE £45** WHEN YOU BUY OUR **CYLINDER KIT** WITH ANY TOWEL RAIL ORDER\* QUOTE **PROMOV3** AT TIME OF ORDER

Available in White or Chrome

Pipe centres left to right	Pipe centres from wall	Depth from wall
50mm	57mm - 67mm	80mm - 90mm

### Stock options White RAL 9016

Height (mm)	Width (mm)	Model	Watts Δt 50°C	Btu's Δt 50°C	White Ex VAT	White Inc VAT	Colours Ex VAT	Colours Inc VAT
DELIVERY TIMES					48-72 HOURS		UP TO 5 WEEKS	
1260	550	PIALAT1255	524	1788	£460.00	£552.00	£575.00	£690.00
1596	550	PIALAT1555	654	2231	£561.00	£673.20	£701.25	£841.50

\*Saving based on the value of individual items when bought separately. Order any of our selected valves & matching pipe covers at the same time as your radiator; PROMOV3W (white), PROMOV3C (chrome).

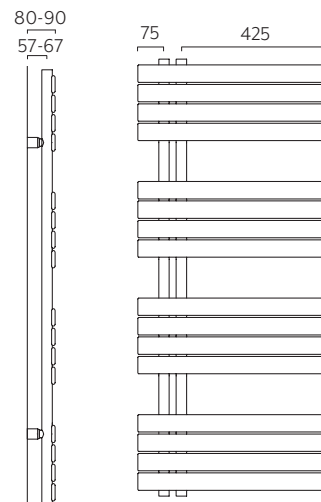

# Piano Towel Rail shown on page 96

High quality Italian design & manufacture  
Steel; 50mm x 10mm flat tubes with 30mm collectors  
CE/UKCA approved & certified to BS EN442.

White RAL 9016 as standard, 188 RAL colours plus 30 Special Finishes  
Please call **01342 302250** for a RAL or Special Finish chart.

## Stock White RAL 9016: 48-72 Hours

Made to Order sizes & colours: Up to 5 weeks.



**SAVE £45** WHEN YOU BUY OUR **CYLINDER KIT** WITH ANY TOWEL RAIL ORDER\*  
QUOTE **PROMOV3** AT TIME OF ORDER

Available in White or Chrome

Pipe centres left to right	Pipe centres from wall	Depth from wall
width - 50mm	55mm	78mm

## Stock options White RAL 9016

Height (mm)	Width (mm)	Model	Watts Δt 50°C	Btu's Δt 50°C	DELIVERY TIMES		Colours Ex VAT	Colours Inc VAT
					48-72 HOURS	UP TO 5 WEEKS		
792	506	PIATR7950	412	1406	<b>£275.00</b>	<b>£330.00</b>	£343.75	£412.50
	606	PIATR7960	483	1648	<b>£281.00</b>	<b>£337.20</b>	£351.25	£421.50
1156	506	PIATRI150	558	1904	<b>£337.00</b>	<b>£404.40</b>	£421.25	£505.50
	606	PIATRI160	658	2245	<b>£343.00</b>	<b>£411.60</b>	£428.75	£514.50
1520	506	PIATRI550	718	2450	<b>£384.00</b>	<b>£460.80</b>	£480.00	£576.00
	606	PIATRI560	848	2893	<b>£395.00</b>	<b>£474.00</b>	£493.75	£592.50

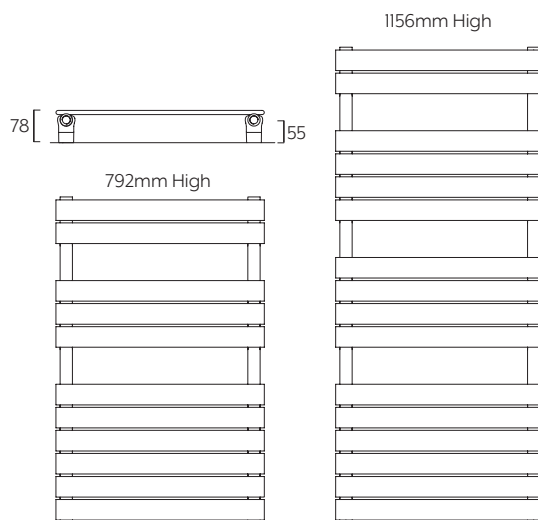

## Made to order options

Height (mm)	Width (mm)	Model	Watts Δt 50°C	Btu's Δt 50°C	DELIVERY TIMES		Colours Ex VAT	Colours Inc VAT
					UP TO 5 WEEKS	UP TO 5 WEEKS		
792	456	PIATR7945	377	1286	£273.00	£327.60	£341.25	£409.50
	556	PIATR7955	447	1525	£276.00	£331.20	£345.00	£414.00
	756	PIATR7975	588	2006	£288.00	£345.60	£360.00	£432.00
1156	456	PIATRI145	507	1730	£332.00	£398.40	£415.00	£498.00
	556	PIATRI155	608	2074	£339.00	£406.80	£423.75	£508.50
	756	PIATRI175	808	2757	£356.00	£427.20	£445.00	£534.00
1520	456	PIATRI545	654	2231	£380.00	£456.00	£475.00	£570.00
	556	PIATRI555	783	2672	£389.00	£466.80	£486.25	£583.50
	756	PIATRI575	1043	3559	£410.00	£492.00	£512.50	£615.00
1744	456	PIATRI745	766	2614	£416.00	£499.20	£520.00	£624.00
	506	PIATRI750	839	2863	£422.00	£506.40	£527.50	£633.00
	556	PIATRI755	912	3112	£426.00	£511.20	£532.50	£639.00
	606	PIATRI760	986	3364	£429.00	£514.80	£536.25	£643.50
	756	PIATRI775	1206	4115	£449.00	£538.80	£561.25	£673.50

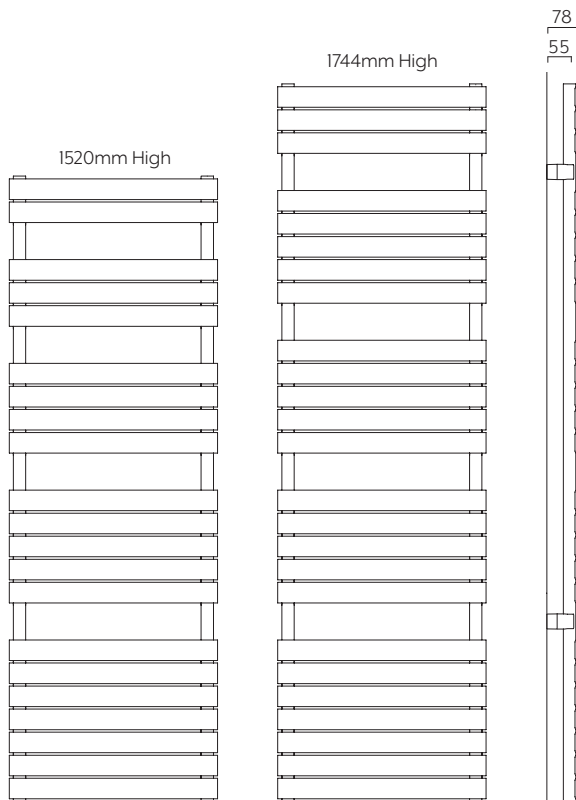

\*Saving based on the value of individual items when bought separately. Order any of our selected valves & matching pipe covers at the same time as your radiator; PROMOV3W (white), PROMOV3C (chrome).

# Quadre shown on page 98



High quality Italian design & manufacture  
Steel; 25mm x 20mm rectangular tubes with 30mm square collectors  
CE/UKCA approved & certified to BS EN442.

White RAL 9016 as standard, 188 RAL Colours and 30 Special Finishes  
Please call **01342 302250** for a RAL or Special Finish chart.

### Stock White RAL 9016: 48-72 Hours

Made to Order sizes & colours: Up to 5 weeks.



**SAVE £45** WHEN YOU BUY OUR **CYLINDER KIT** WITH ANY TOWEL RAIL ORDER\*  
QUOTE **PROMOV3** AT TIME OF ORDER

Available in White or Chrome

Pipe centres left to right	Pipe centres from wall	Depth from wall
width - 30mm	58mm to 68mm	73mm to 83mm

### Stock options White RAL 9016

Height (mm)	Width (mm)	Model	Watts Δt 50°C	Btu's Δt 50°C	White Ex VAT	White Inc VAT	Colours Ex VAT	Colours Inc VAT
DELIVERY TIMES					48-72 HOURS		UP TO 5 WEEKS	
1216	430	QUADI243	507	1730	£232.00	£278.40	£290.00	£348.00
	580	QUADI258	667	2276	£254.00	£304.80	£317.50	£381.00

Made to order options - Hydronic

Height (mm)	Width (mm)	Model	Watts Δt 50°C	Btu's Δt 50°C	White Ex VAT	White Inc VAT	Colours Ex VAT	Colours Inc VAT
DELIVERY TIMES					UP TO 5 WEEKS		UP TO 5 WEEKS	
872	430	QUAD8743	372	1269	£203.00	£243.60	£253.75	£304.50
	530	QUAD8753	453	1546	£215.00	£258.00	£268.75	£322.50
	580	QUAD8758	493	1682	£220.00	£264.00	£275.00	£330.00
1216	530	QUADI253	613	2092	£247.00	£296.40	£308.75	£370.50
1517	430	QUADI543	652	2225	£255.00	£306.00	£318.75	£382.50
	530	QUADI553	747	2549	£275.00	£330.00	£343.75	£412.50
	580	QUADI558	812	2771	£282.00	£338.40	£352.50	£423.00
1818	430	QUADI843	801	2733	£286.00	£343.20	£357.50	£429.00
	530	QUADI853	912	3112	£308.00	£369.60	£385.00	£462.00
	580	QUADI858	992	3385	£319.00	£382.80	£398.75	£478.50

73-83 [ ] 58-68

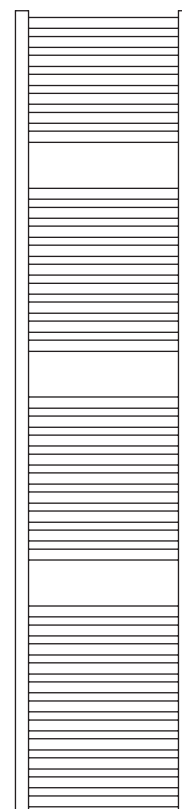
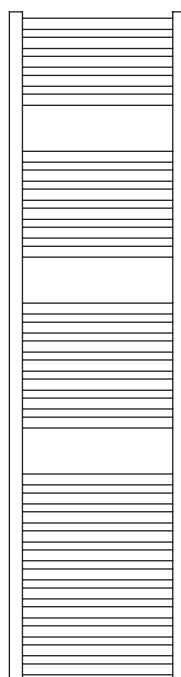
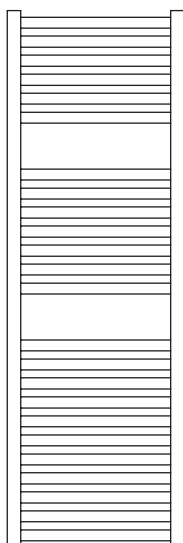
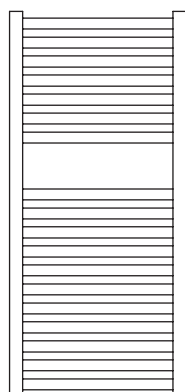

73-83  
58-68

\*Saving based on the value of individual items when bought separately. Order any of our selected valves & matching pipe covers at the same time as your radiator; PROMOV3W (white), PROMOV3C (chrome).

# Griffin shown on page 99

Steel; 40mm trapezoid collectors, 32mm flat cross tubes  
Hydronic & Electric models  
CE/UKCA approved & certified to BS EN442.

White RAL 9016 as standard, 188 RAL Colours and 30 Special Finishes  
Please call **01342 302250** for a RAL or Special Finish chart.

## Stock White RAL 9016: 48-72 Hours

Made to Order White & Colours: 7 weeks for white, 8 weeks for colours  
Made to Order Electric: Up to 7 weeks.



**SAVE £45** WHEN YOU BUY OUR **CYLINDER KIT** WITH ANY TOWEL RAIL ORDER\* QUOTE **PROMOV3** AT TIME OF ORDER

Available in White or Chrome

Pipe centres left to right	Pipe centres from wall	Depth from wall
width - 43mm	60mm to 68mm	77mm to 85mm

## Stock options White RAL 9016

Height (mm)	Width (mm)	Model	Watts Δt 50°C	Btu's Δt 50°C	White Ex VAT	White Inc VAT	Colours Ex VAT	Colours Inc VAT
DELIVERY TIMES					48-72 HOURS		UP TO 8 WEEKS	
860	600	GRIF8660	464	1583	£274.00	£328.80	£342.50	£411.00
1220	400	GRIF1240	440	1501	£326.00	£391.20	£407.50	£489.00
	500	GRIF1250	541	1846	£339.00	£406.80	£423.75	£508.50
	600	GRIF1260	640	2184	£350.00	£420.00	£437.50	£525.00
1760	500	GRIF1750	762	2600	£487.00	£584.40	£608.75	£730.50

60-68 [ ] 77-85

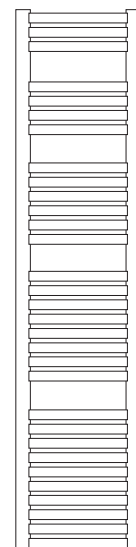
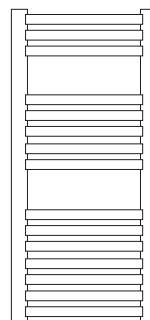

Made to order options - White & colours

Height (mm)	Width (mm)	Model	Watts Δt 50°C	Btu's Δt 50°C	White Ex VAT	White Inc VAT	Colours Ex VAT	Colours Inc VAT
DELIVERY TIMES					UP TO 7 WEEKS		UP TO 8 WEEKS	
860	400	GRIF8640	323	1102	£255.00	£306.00	£318.75	£382.50
	500	GRIF8650	394	1344	£265.00	£318.00	£331.25	£397.50
1760	400	GRIF1740	618	2109	£468.00	£561.60	£585.00	£702.00
	600	GRIF1760	906	3091	£507.00	£608.40	£633.75	£760.50

\*Saving based on the value of individual items when bought separately. Order any of our selected valves & matching pipe covers at the same time as your radiator; PROMOV3W (white), PROMOV3C (chrome).

Made to order options - Electric White

Height (mm)	Width (mm)	Model	Watts Δt 50°C	White Ex VAT	White Inc VAT
DELIVERY TIMES					
UP TO 7 WEEKS					
860	500	GRIF8650EW	400	£523.00	£627.60
	600	GRIF8660EW	600	£542.00	£650.40
1220	500	GRIF1250EW	600	£616.00	£739.20
	600	GRIF1260EW	800	£645.00	£774.00
1760	500	GRIF1750EW	800	£806.00	£967.20
	600	GRIF1760EW	1000	£845.00	£1,014.00



Griffin Electric option

Griffin Electric models supplied with a MOA Element:

- 5 heat settings from 30°C to 60°C to regulate the internal radiator temperature. Selected setting denoted by 5 LEDs.
- No Timer.
- Compatible with external Timer as remembers settings when turned off
- 55mm diameter clock shaped face.
- 4x Buttons: Temperature +/-, Dryer, Power.
- Frost & overheating protection.
- Straight cable, no plug. IPx5. Class 1. Guarantee - 2 years.

# Pulsar shown on page 100

High quality Italian design & manufacture.  
Steel; frame style, elliptical cross tubes  
CE/UKCA approved & certified to BS EN442.

White RAL 9016 as standard, 188 RAL Colours and 30 Special Finishes  
Please call **01342 302250** for a RAL or Special Finish chart.

## Stock White RAL 9016: 48-72 Hours

Made to Order sizes & colours: Up to 5 weeks.

Pipe centres left to right	Pipe centres from wall	Depth from wall
width - 44mm	71mm - 86mm	92mm - 107mm

## Stock options White RAL 9016

Height (mm)	Width (mm)	Model	Watts Δt 50°C	Btu's Δt 50°C	White Ex VAT	White Inc VAT	Colours Ex VAT	Colours Inc VAT
DELIVERY TIMES					48-72 HOURS		UP TO 5 WEEKS	
1224	500	PULSI250	604	2061	£414.00	£496.80	£517.50	£621.00
	600	PULSI260	710	2423	£428.00	£513.60	£535.00	£642.00

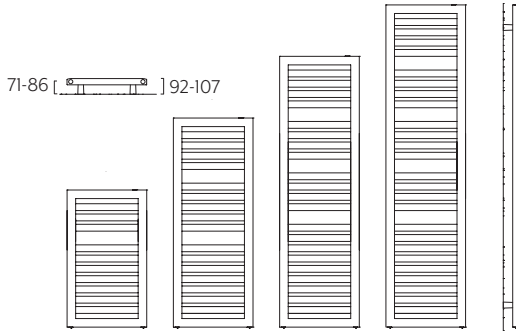

## Cylinder Valve Kit



**SAVE £45** WHEN YOU BUY OUR **CYLINDER KIT** WITH ANY TOWEL RAIL ORDER\* QUOTE **PROMOV3** AT TIME OF ORDER

Available in White or Chrome

Made to order options - White & colours

Height (mm)	Width (mm)	Model	Watts Δt 50°C	Btu's Δt 50°C	White Ex VAT	White Inc VAT	Colours Ex VAT	Colours Inc VAT
DELIVERY TIMES					UP TO 5 WEEKS		UP TO 5 WEEKS	
804	450	PULS8045	374	1276	£334.00	£400.80	£417.50	£501.00
	500	PULS8050	409	1396	£339.00	£406.80	£423.75	£508.50
	600	PULS8060	479	1634	£349.00	£418.80	£436.25	£523.50
1224	450	PULSI245	551	1880	£407.00	£488.40	£508.75	£610.50
1584	450	PULSI545	684	2334	£500.00	£600.00	£625.00	£750.00
	500	PULSI550	753	2569	£524.00	£628.80	£655.00	£786.00
	600	PULSI560	892	3044	£536.00	£643.20	£670.00	£804.00
1884	450	PULSI845	825	2815	£589.00	£706.80	£736.25	£883.50
	500	PULSI850	903	3081	£611.00	£733.20	£763.75	£916.50
	600	PULSI860	1058	3610	£632.00	£758.40	£790.00	£948.00

\*Saving based on the value of individual items when bought separately. Order any of our selected valves & matching pipe covers at the same time as your radiator; PROMOV3W (white), PROMOV3C (chrome).

# Blues shown on page 112

Stainless Steel; 15mm x 30mm horizontal tubes with 30mm x 30mm collectors  
Suitable for a direct system  
CE/UKCA approved & certified to BS EN442.

Polished or Satin Stainless Steel

## Stock Polished Stainless Steel: 48-72 Hours

Made to Order Satin Stainless Steel: Up to 4 weeks

Pipe centres left to right	Pipe centres from wall	Depth from wall
50mm	55mm to 70mm	85mm to 100mm

## Stock options Polished Stainless Steel

Height (mm)	Width (mm)	Model	Watts Δt 50°C	Btu's Δt 50°C	Polished Stainless Steel Ex VAT	Polished Stainless Steel Inc VAT
DELIVERY TIMES					48-72 HOURS	
770	500	BLUE7750	236	805	£1,078.00	£1,293.60
1190	500	BLUE1150	337	1150	£1,524.00	£1,828.80
1400	500	BLUE1450	379	1293	£1,821.00	£2,185.20

Made to order options - Satin Stainless Steel

Height (mm)	Width (mm)	Model	Watts Δt 50°C	Btu's Δt 50°C	Satin Stainless Steel Ex VAT	Satin Stainless Steel Inc VAT
DELIVERY TIMES					UP TO 4 WEEKS	
770	500	BLUE7750	236	805	£725.00	£870.00
1190	500	BLUE1150	337	1150	£1,078.00	£1,293.60
1400	500	BLUE1450	379	1293	£1,264.00	£1,516.80



## Cylinder Valve Kit



**SAVE £45** WHEN YOU BUY OUR **CYLINDER KIT** WITH ANY TOWEL RAIL ORDER\* QUOTE **PROMOV3** AT TIME OF ORDER

Available in White or Chrome

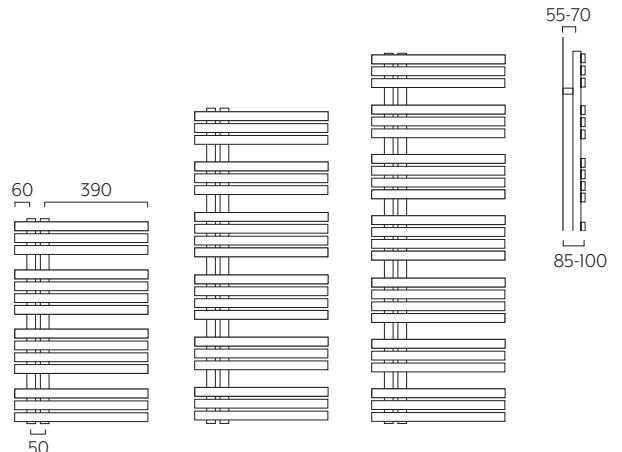

# Ellipsis Towel Rail shown on page 101



High quality Italian design & manufacture  
Steel; elliptical tube towel rail.  
CE/UKCA approved & certified to BS EN442.

White RAL 9016 as standard, 188 RAL Colours and 30 Special Finishes  
Please call **01342 302250** for a RAL or Special Finish chart.

### Stock White RAL 9016: 48-72 Hours

Made to Order sizes & colours: Up to 5 weeks.



**SAVE £45** WHEN YOU BUY OUR **CYLINDER KIT** WITH ANY TOWEL RAIL ORDER\*  
QUOTE **PROMOV3** AT TIME OF ORDER

Available in White or Chrome

Pipe centres left to right	Pipe centres from wall	Depth from wall
width - 50mm	55mm	93mm

### Stock options White RAL 9016

Height (mm)	Width (mm)	Model	Watts Δt 50°C	Btu's Δt 50°C	White Ex VAT	White Inc VAT	Colours Ex VAT	Colours Inc VAT
DELIVERY TIMES					48-72 HOURS		UP TO 5 WEEKS	
960	500	ELLITR9650	453	1546	£312.00	£374.40	£390.00	£468.00
1200	400	ELLITR1240	457	1559	£372.00	£446.40	£465.00	£558.00
	500	ELLITR1250	549	1873	£378.00	£453.60	£472.50	£567.00
	600	ELLITR1260	641	2187	£402.00	£482.40	£502.50	£603.00
1380	400	ELLITR1340	528	1802	£435.00	£522.00	£543.75	£652.50
	500	ELLITR1350	638	2177	£445.00	£534.00	£556.25	£667.50
	600	ELLITR1360	748	2552	£467.00	£560.40	£583.75	£700.50
1620	500	ELLITR1650	729	2487	£510.00	£612.00	£637.50	£765.00

Made to order options

Height (mm)	Width (mm)	Model	Watts Δt 50°C	Btu's Δt 50°C	White Ex VAT	White Inc VAT	Colours Ex VAT	Colours Inc VAT
DELIVERY TIMES					UP TO 5 WEEKS		UP TO 5 WEEKS	
960	400	ELLITR9640	371	1266	£306.00	£367.20	£382.50	£459.00
	600	ELLITR9660	534	1822	£331.00	£397.20	£413.75	£496.50
1620	400	ELLITR1640	606	2068	£500.00	£600.00	£625.00	£750.00
	600	ELLITR1660	853	2910	£536.00	£643.20	£670.00	£804.00

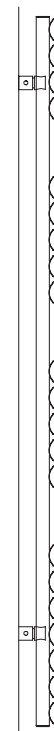
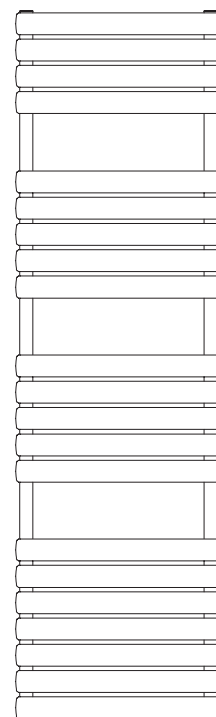
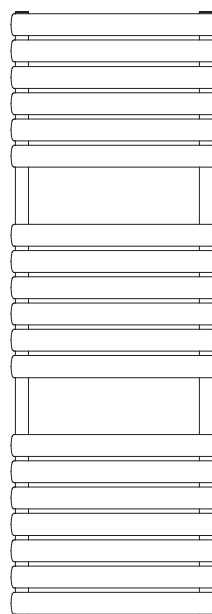
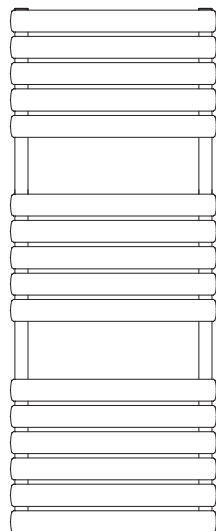
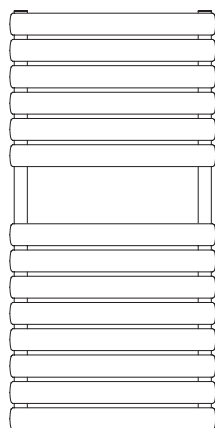
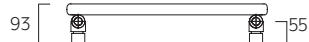

\*Saving based on the value of individual items when bought separately. Order any of our selected valves & matching pipe covers at the same time as your radiator; PROMOV3W (white), PROMOV3C (chrome).

# Sitar Lato shown on page 102

High quality Italian design & manufacture.  
Steel: 23mm cross tubes  
CE/UKCA approved & certified to BS EN442.

White RAL 9016 as standard, 188 RAL Colours and 30 Special Finishes  
Please call **01342 302250** for a RAL or Special Finish chart.

**Stock White RAL 9016: 48-72 Hours**

Made to Order sizes & colours: Up to 5 weeks.

## Stock options White RAL 9016

Height (mm)	Width (mm)	Model	Watts Δt 50°C	Btu's Δt 50°C	White Ex VAT	White Inc VAT	Colours Ex VAT	Colours Inc VAT
DELIVERY TIMES					48-72 HOURS		UP TO 5 WEEKS	
832	500	SITLAT8350	394	1344	£301.00	£361.20	£376.25	£451.50
	600	SITLAT8360	455	1552	£310.00	£372.00	£387.50	£465.00
1348	500	SITLAT1350	612	2088	£368.00	£441.60	£460.00	£552.00
	600	SITLAT1360	708	2416	£380.00	£456.00	£475.00	£570.00

Made to order options

Height (mm)	Width (mm)	Model	Watts Δt 50°C	Btu's Δt 50°C	White Ex VAT	White Inc VAT	Colours Ex VAT	Colours Inc VAT
DELIVERY TIMES					UP TO 5 WEEKS		UP TO 5 WEEKS	
832	700	SITLAT8370	515	1757	£328.00	£393.60	£410.00	£492.00
1348	700	SITLAT1370	801	2733	£404.00	£484.80	£505.00	£606.00
1778	500	SITLAT1750	799	2726	£440.00	£528.00	£550.00	£660.00
	600	SITLAT1760	924	3153	£459.00	£550.80	£573.75	£688.50
	700	SITLAT1770	1044	3562	£485.00	£582.00	£606.25	£727.50

\*Saving based on the value of individual items when bought separately. Order any of our selected valves & matching pipe covers at the same time as your radiator; PROMOV3W (white), PROMOV3C (chrome).



### Cylinder Valve Kit



**SAVE £45** WHEN YOU BUY OUR **CYLINDER KIT** WITH ANY TOWEL RAIL ORDER\* QUOTE **PROMOV3** AT TIME OF ORDER

Available in White or Chrome

<b>Pipe centres left to right</b>
50mm
<b>Pipe centres from wall</b>
57mm - 67mm
<b>Depth from wall</b>
92mm - 102mm

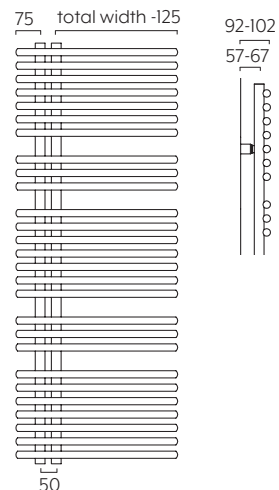

# Sitar BDO shown on page 103

High quality Italian design & manufacture  
Steel: 23mm cross tubes  
CE/UKCA approved & certified to BS EN442.

White RAL 9016 as standard, 188 RAL Colours and 30 Special Finishes  
Please call **01342 302250** for a RAL or Special Finish chart.

**Stock White RAL 9016: 48-72 Hours**

Made to Order sizes & colours: Up to 5 weeks.

## Stock options White RAL 9016

Height (mm)	Width (mm)	Model	Watts Δt 50°C	Btu's Δt 50°C	White Ex VAT	White Inc VAT	Colours Ex VAT	Colours Inc VAT
DELIVERY TIMES					48-72 HOURS		UP TO 5 WEEKS	
373	1220	SITBDO3712	517	1764	£398.00	£477.60	£497.50	£597.00
	1520	SITBDO3715	647	2208	£479.00	£574.80	£598.75	£718.50
543	1220	SITBDO5412	776	2648	£497.00	£596.40	£621.25	£745.50
	1520	SITBDO5415	967	3299	£555.00	£666.00	£693.75	£832.50

Made to order options

Height (mm)	Width (mm)	Model	Watts Δt 50°C	Btu's Δt 50°C	White Ex VAT	White Inc VAT	Colours Ex VAT	Colours Inc VAT
DELIVERY TIMES					UP TO 5 WEEKS		UP TO 5 WEEKS	
373	520	SITBDO3752	240	819	£276.00	£331.20	£345.00	£414.00
543	520	SITBDO5452	360	1228	£319.00	£382.80	£398.75	£478.50
985	520	SITBDO9852	646	2204	£437.00	£524.40	£546.25	£655.50
	1220	SITBDO9812	1383	4719	£676.00	£811.20	£845.00	£1,014.00
	1520	SITBDO9815	1716	5855	£746.00	£895.20	£932.50	£1,119.00



### Cylinder Valve Kit



**SAVE £45** WHEN YOU BUY OUR **CYLINDER KIT** WITH ANY TOWEL RAIL ORDER\* QUOTE **PROMOV3** AT TIME OF ORDER

Available in White or Chrome

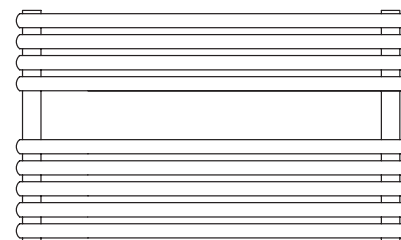
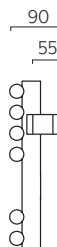

<b>Pipe centres left to right</b>	<b>Pipe centres from wall</b>	<b>Depth from wall</b>
width - 50mm	55mm	90mm

\*Saving based on the value of individual items when bought separately. Order any of our selected valves & matching pipe covers at the same time as your radiator; PROMOV3W (white), PROMOV3C (chrome).



# Poll BDO shown on page 104

Steel; 30mm square collectors, 22mm round cross tubes  
CE/UKCA approved & certified to BS EN442.

White RAL 9016 as standard, 188 RAL Colours and 30 Special Finishes  
Please call **01342 302250** for a RAL or Special Finish chart.

## Stock White RAL 9016: 48-72 Hours

Made to Order sizes & colours: Up to 7 weeks for white,  
8 weeks for colours.



**SAVE £45** WHEN YOU BUY OUR **CYLINDER KIT** WITH ANY TOWEL RAIL ORDER\*  
QUOTE **PROMOV3** AT TIME OF ORDER

Available in White or Chrome

Pipe centres left to right	Pipe centres from wall	Depth from wall
width - 30mm	57mm to 65mm	132mm to 140mm

## Stock options White RAL 9016

Height (mm)	Width (mm)	Model	Watts Δt 50°C	Btu's Δt 50°C	White Ex VAT	White Inc VAT	Colours Ex VAT	Colours Inc VAT
DELIVERY TIMES					48-72 HOURS		UP TO 8 WEEKS	
460	1200	POLBDO4612	574	1958	£250.00	£300.00	£312.50	£375.00
540	1200	POLBDO5412	691	2358	£282.00	£338.40	£352.50	£423.00

Made to order options - White & colours

Height (mm)	Width (mm)	Model	Watts Δt 50°C	Btu's Δt 50°C	White Ex VAT	White Inc VAT	Colours Ex VAT	Colours Inc VAT
DELIVERY TIMES					UP TO 7 WEEKS		UP TO 8 WEEKS	
460	1000	POLBDO4610	478	1631	£241.00	£289.20	£301.25	£361.50
	1400	POLBDO4614	670	2286	£262.00	£314.40	£327.50	£393.00
540	1000	POLBDO5410	576	1965	£269.00	£322.80	£336.25	£403.50
	1400	POLBDO5414	806	2750	£295.00	£354.00	£368.75	£442.50
660	1000	POLBDO6610	724	2470	£310.00	£372.00	£387.50	£465.00
	1200	POLBDO6612	869	2965	£329.00	£394.80	£411.25	£493.50
	1400	POLBDO6614	1014	3460	£344.00	£412.80	£430.00	£516.00

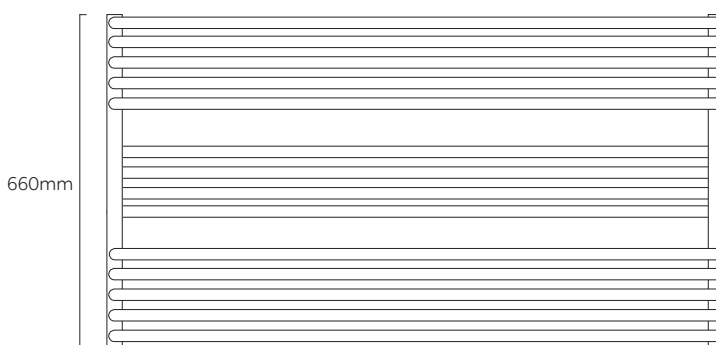
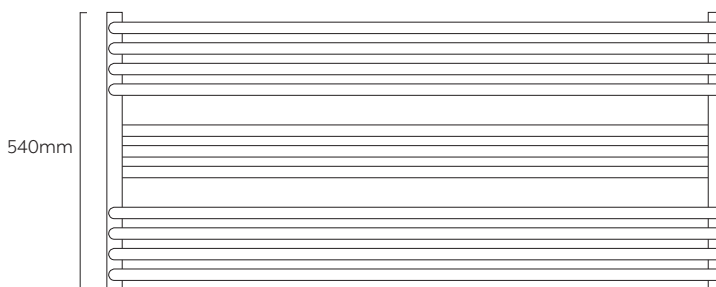
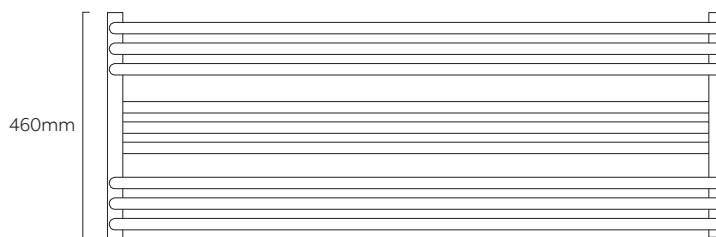
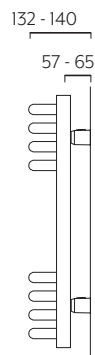

\*Saving based on the value of individual items when bought separately. Order any of our selected valves & matching pipe covers at the same time as your radiator; PROMOV3W (white), PROMOV3C (chrome).

# Poll shown on page 105

Steel; 30mm square collectors, 22mm round cross tubes  
Hydronic & Electric models  
CE/UKCA approved & certified to BS EN442.

White RAL 9016 as standard, 188 RAL Colours and 30 Special Finishes  
Please call **01342 302250** for a RAL or Special Finish chart.

## Stock White RAL 9016: 48-72 Hours

Made to Order sizes & colours: Up to 7 weeks: White Electric,  
Up to 8 weeks: Colours.



**SAVE £45** WHEN YOU BUY OUR **CYLINDER KIT** WITH ANY TOWEL RAIL ORDER\*  
QUOTE **PROMOV3** AT TIME OF ORDER

Available in White or Chrome

Poll	Pipe centres left to right	Pipe centres from wall
Poll	width - 30mm	57mm to 65mm

## Stock options White RAL 9016

Height (mm)	Width (mm)	Model	Watts Δt 50°C	Btu's Δt 50°C	White Ex VAT	White Inc VAT	Colours Ex VAT	Colours Inc VAT
DELIVERY TIMES					48-72 HOURS		UP TO 8 WEEKS	
530	450	POLL5345	270	921	<b>£224.00</b>	<b>£268.80</b>	£280.00	£336.00
	500	POLL5350	300	1024	<b>£230.00</b>	<b>£276.00</b>	£287.50	£345.00
	600	POLL5360	360	1228	<b>£240.00</b>	<b>£288.00</b>	£300.00	£360.00
	700	POLL5370	410	1399	<b>£245.00</b>	<b>£294.00</b>	£306.25	£367.50
1055	450	POLL1045	540	1842	<b>£285.00</b>	<b>£342.00</b>	£356.25	£427.50
	500	POLL1050	604	2061	<b>£294.00</b>	<b>£352.80</b>	£367.50	£441.00
	600	POLL1060	720	2457	<b>£312.00</b>	<b>£374.40</b>	£390.00	£468.00
	700	POLL1070	850	2900	<b>£326.00</b>	<b>£391.20</b>	£407.50	£489.00
1480	500	POLL1450	857	2924	<b>£402.00</b>	<b>£482.40</b>	£502.50	£603.00
	600	POLL1460	1030	3514	<b>£411.00</b>	<b>£493.20</b>	£513.75	£616.50
	700	POLL1470	1200	4094	<b>£429.00</b>	<b>£514.80</b>	£536.25	£643.50
	800	POLL1480	1370	4674	<b>£442.00</b>	<b>£530.40</b>	£552.50	£663.00

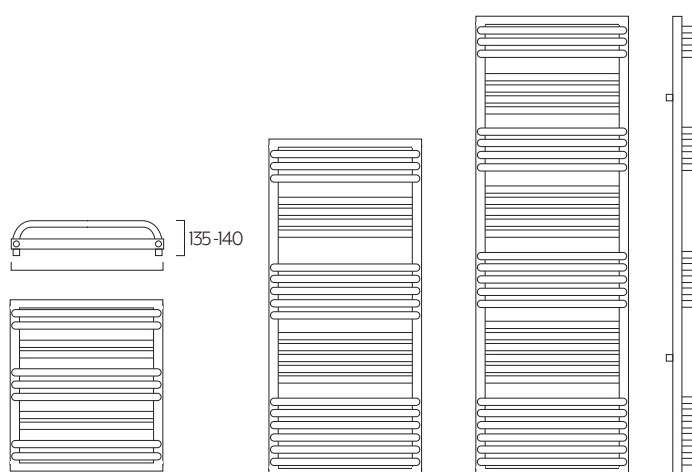

\*Saving based on the value of individual items when bought separately. Order any of our selected valves & matching pipe covers at the same time as your radiator; PROMOV3W (white), PROMOV3C (chrome).

## Made to order options - White Electric

Height (mm)	Width (mm)	Model	Watts Δt 50°C	White Ex VAT	White Inc VAT
DELIVERY TIMES			UP TO 7 WEEKS		
780	500	POLL7850EW	400	£289.00	£346.80
	600	POLL7860EW	400	£307.00	£368.40
1180	500	POLL1150EW	600	£365.00	£438.00
	600	POLL1160EW	800	£391.00	£469.20
1580	500	POLL1550EW	800	£428.00	£513.60
	600	POLL1560EW	1000	£481.00	£577.20

## Poll Electric models supplied with a MOA Element:

- 5 heat settings from 30°C to 60°C to regulate the internal radiator temperature. Selected setting denoted by 5 LEDs.
- No Timer.
- Compatible with external Timer as remembers settings when turned off
- 55mm diameter clock shaped face.
- 4x Buttons: Temperature +/-, Dryer, Power.
- Frost & overheating protection.
- Straight cable, no plug. IPx5. Class I.
- Guarantee - 2 years.

# Poppy Towel Rail pages 106-107

High quality Italian design & manufacture

Steel; 25mm curved cross tubes with 40mm 'D' shaped collectors  
CE/UKCA approved & certified to BS EN442.

White RAL 9016 as standard, 23 RAL colours plus 30 Special Finishes + Chrome  
Please call **01342 302250** for a RAL or Special Finish chart.

## Stock White RAL 9016 & Chrome: 48-72 Hours

Made to Order colours: Up to 3 weeks

Up to 6 weeks for White electric, 8 weeks for Chrome electric.



**SAVE £45** WHEN YOU BUY OUR **CYLINDER KIT** WITH ANY TOWEL RAIL ORDER\*  
QUOTE **PROMOV3** AT TIME OF ORDER

Available in White or Chrome

Pipe centres left to right	Pipe centres left to right	Depth from wall
width - 44mm	398mm wide = 70mm-80mm 498mm wide = 68mm-78mm 598mm wide = 68mm-78mm	398mm wide = 95mm-105mm 498mm wide = 100mm-110mm 598mm wide = 105mm-115mm

## Stock options White RAL 9016

Height (mm)	Width (mm)	Model	Watts Δt 50°C	Btu's Δt 50°C	White Ex VAT	White Inc VAT	Colours Ex VAT	Colours Inc VAT
DELIVERY TIMES					48-72 HOURS		UP TO 3 WEEKS	
718	398	POPP7139	296	1010	£125.00	£150.00	£221.25	£265.50
	498	POPP7149	351	1198	£130.00	£156.00	£230.10	£276.12
	598	POPP7159	406	1385	£142.00	£170.40	£251.34	£301.61
1210	398	POPP1239	472	1610	£172.00	£206.40	£304.44	£365.33
	498	POPP1249	557	1900	£185.00	£222.00	£327.45	£392.94
	598	POPP1259	641	2187	£194.00	£232.80	£343.38	£412.06
1497	398	POPP1439	578	1972	£187.00	£224.40	£330.99	£397.19
	498	POPP1449	682	2327	£199.00	£238.80	£352.23	£422.68
	598	POPP1459	785	2678	£210.00	£252.00	£371.70	£446.04
1866	398	POPP1839	722	2463	£207.00	£248.40	£366.39	£439.67
	498	POPP1849	851	2904	£216.00	£259.20	£382.32	£458.78
	598	POPP1859	980	3344	£225.00	£270.00	£398.25	£477.90

23 RAL colours are shown on page 197

\*Saving based on the value of individual items when bought separately. Order any of our selected valves & matching pipe covers at the same time as your radiator; PROMOV3W (white), PROMOV3C (chrome).

## Stock options Chrome

Height (mm)	Width (mm)	Model	Watts Δt 50°C	Btu's Δt 50°C	Chrome Ex VAT	Chrome Inc VAT
DELIVERY TIMES					48-72 HOURS	
718	398	POPP7139C	183	624	£378.00	£453.60
	498	POPP7149C	218	744	£382.00	£458.40
	598	POPP7159C	252	860	£393.00	£471.60
1210	398	POPP1239C	292	996	£508.00	£609.60
	498	POPP1249C	345	1177	£510.00	£612.00
	598	POPP1259C	398	1358	£534.00	£640.80
1497	398	POPP1439C	359	1225	£554.00	£664.80
	498	POPP1449C	423	1443	£562.00	£674.40
	598	POPP1459C	487	1662	£583.00	£699.60
1866	398	POPP1839C	448	1529	£601.00	£721.20
	498	POPP1849C	528	1802	£607.00	£728.40
	598	POPP1859C	608	2074	£633.00	£759.60

## Made to order options - White electric

Height (mm)	Width (mm)	Model	Watts Δt 50°C	White Ex VAT	White Inc VAT
DELIVERY TIMES			UP TO 6 WEEKS		
718	398	POPP7139EW	300	£301.00	£361.20
	498	POPP7149EW	400	£304.00	£364.80
	598	POPP7159EW	400	£314.00	£376.80
1210	398	POPP1239EW	400	£343.00	£411.60
	498	POPP1249EW	600	£358.00	£429.60
	598	POPP1259EW	600	£365.00	£438.00
1497	398	POPP1439EW	600	£360.00	£432.00
	498	POPP1449EW	800	£371.00	£445.20
	598	POPP1459EW	800	£380.00	£456.00
1866	398	POPP1839EW	800	£377.00	£452.40
	498	POPP1849EW	1000	£384.00	£460.80
	598	POPP1859EW	1000	£395.00	£474.00

## Made to order options - Chrome electric

Height (mm)	Width (mm)	Model	Watts Δt 50°C	Chrome Ex VAT	Chrome Inc VAT
DELIVERY TIMES			UP TO 8 WEEKS		
718	398	POPP7139EC	200	£541.00	£649.20
	498	POPP7149EC	300	£545.00	£654.00
	598	POPP7159EC	300	£554.00	£664.80
1210	398	POPP1239EC	300	£664.00	£796.80
	498	POPP1249EC	400	£666.00	£799.20
	598	POPP1259EC	400	£689.00	£826.80
1497	398	POPP1439EC	400	£707.00	£848.40
	498	POPP1449EC	400	£716.00	£859.20
	598	POPP1459EC	600	£736.00	£883.20
1866	398	POPP1839EC	400	£752.00	£902.40
	498	POPP1849EC	600	£759.00	£910.80
	598	POPP1859EC	800	£784.00	£940.80

398mm wide = 70mm-80mm  
498mm wide = 68mm-78mm  
598mm wide = 68mm-78mm

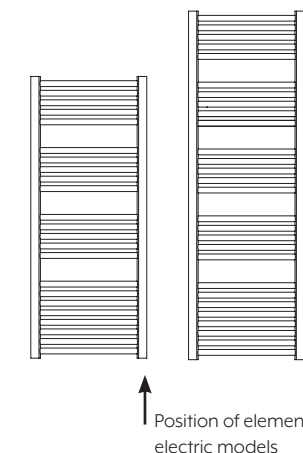

The Poppy Electric range is available in white & chrome and supplied with a fully controllable electric element. Offering 8 function modes, they can be set to operate when you wish, on a daily basis or you can select one of the three pre-set programmes. The Open Window function detects an open external door or window and will turn the radiator off if it detects that it is allowing heat to escape, saving energy and money.

- Boost mode (2h at max power)
- Timer mode (configure different temperature values for each hour and day of the week),
- Comfort mode (desired user temperature),
- Night mode, Pilot-wire mode, Antifreeze mode, Holiday mode
- Adaptive Start Control, open windows, ON/OFF button and a security lock for children.

# Lupin Towel Rail pages 108-109

High quality Italian design & manufacture  
Steel; 25mm straight cross tubes with 40mm 'D' shaped collectors  
CE/UKCA approved & certified to BS EN442.

White RAL 9016 as standard, 23 RAL colours plus 30 Special Finishes + Chrome  
Please call **01342 302250** for a RAL or Special Finish chart.

## Stock White RAL 9016 & Chrome: 48-72 Hours

Made to Order colours: Up to 3 weeks  
Up to 6 weeks for White electric, 8 weeks for Chrome electric.



**SAVE £45** WHEN YOU BUY OUR **CYLINDER KIT** WITH ANY TOWEL RAIL ORDER\*  
QUOTE **PROMOV3** AT TIME OF ORDER

Available in White or Chrome

Pipe centres left to right	Pipe centres from wall	Depth from wall
width - 44mm	57mm to 67mm	72mm to 82mm

## Stock options White RAL 9016

Height (mm)	Width (mm)	Model	Watts $\Delta t$ 50°C	Btu's $\Delta t$ 50°C	White Ex VAT	White Inc VAT	Colours Ex VAT	Colours Inc VAT
DELIVERY TIMES					48-72 HOURS		UP TO 3 WEEKS	
718	400	LUPI7140	293	1000	£118.00	£141.60	£214.76	£257.71
	500	LUPI7150	363	1239	£121.00	£145.20	£220.22	£264.26
	600	LUPI7160	432	1474	£130.00	£156.00	£236.60	£283.92
1210	400	LUPI1240	472	1610	£156.00	£187.20	£283.92	£340.70
	500	LUPI1250	572	1952	£172.00	£206.40	£313.04	£375.65
	600	LUPI1260	671	2289	£179.00	£214.80	£325.78	£390.94
1497	400	LUPI1440	579	1976	£174.00	£208.80	£316.68	£380.02
	500	LUPI1450	700	2388	£185.00	£222.00	£336.70	£404.04
	600	LUPI1460	821	2801	£194.00	£232.80	£353.08	£423.70
1866	400	LUPI1840	717	2446	£191.00	£229.20	£347.62	£417.14
	500	LUPI1850	867	2958	£195.00	£234.00	£354.90	£425.88
	600	LUPI1860	1016	3467	£209.00	£250.80	£380.38	£456.46

## Stock options Chrome

Height (mm)	Width (mm)	Model	Watts $\Delta t$ 50°C	Btu's $\Delta t$ 50°C	Chrome Ex VAT	Chrome Inc VAT
DELIVERY TIMES					48-72 HOURS	
718	400	LUPI7140C	202	689	£329.00	£394.80
	500	LUPI7150C	243	829	£331.00	£397.20
	600	LUPI7160C	285	972	£339.00	£406.80
1210	400	LUPI1240C	306	1044	£443.00	£531.60
	500	LUPI1250C	374	1276	£444.00	£532.80
	600	LUPI1260C	442	1508	£463.00	£555.60
1497	400	LUPI1440C	378	1290	£482.00	£578.40
	500	LUPI1450C	456	1556	£488.00	£585.60
	600	LUPI1460C	534	1822	£506.00	£607.20
1866	400	LUPI1840C	463	1580	£522.00	£626.40
	500	LUPI1850C	568	1938	£530.00	£636.00
	600	LUPI1860C	673	2296	£550.00	£660.00

23 RAL colours are shown on page 197

\*Saving based on the value of individual items when bought separately. Order any of our selected valves & matching pipe covers at the same time as your radiator; PROMOV3W (white), PROMOV3C (chrome).

Made to order options - White electric

Height (mm)	Width (mm)	Model	Watts $\Delta t$ 50°C	White Ex VAT	White Inc VAT
DELIVERY TIMES			UP TO 6 WEEKS		
718	400	LUPI7140EW	300	£292.00	£350.40
	500	LUPI7150EW	400	£295.00	£354.00
	600	LUPI7160EW	400	£304.00	£364.80
1210	400	LUPI1240EW	400	£329.00	£394.80
	500	LUPI1250EW	600	£343.00	£411.60
	600	LUPI1260EW	600	£350.00	£420.00
1497	400	LUPI1440EW	600	£346.00	£415.20
	500	LUPI1450EW	800	£358.00	£429.60
	600	LUPI1460EW	800	£365.00	£438.00
1866	400	LUPI1840EW	800	£362.00	£434.40
	500	LUPI1850EW	1000	£366.00	£439.20
	600	LUPI1860EW	1000	£379.00	£454.80

Made to order options - Chrome electric

Height (mm)	Width (mm)	Model	Watts $\Delta t$ 50°C	Chrome Ex VAT	Chrome Inc VAT
DELIVERY TIMES			UP TO 8 WEEKS		
718	400	LUPI7140EC	200	£494.00	£592.80
	500	LUPI7150EC	300	£496.00	£595.20
	600	LUPI7160EC	300	£502.00	£602.40
1210	400	LUPI1240EC	300	£601.00	£721.20
	500	LUPI1250EC	400	£602.00	£722.40
	600	LUPI1260EC	400	£622.00	£746.40
1497	400	LUPI1440EC	400	£639.00	£766.80
	500	LUPI1450EC	400	£646.00	£775.20
	600	LUPI1460EC	600	£663.00	£795.60
1866	400	LUPI1840EC	400	£677.00	£812.40
	500	LUPI1850EC	600	£685.00	£822.00
	600	LUPI1860EC	800	£704.00	£844.80

157-67

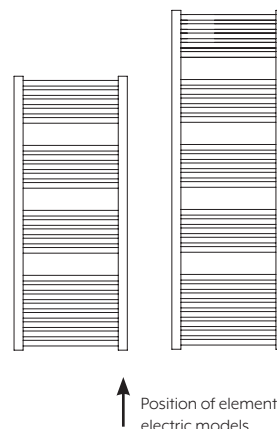

The Lupin Electric range is available in white & chrome and supplied with a fully controllable electric element. Offering 8 function modes, they can be set to operate when you wish, on a daily basis or you can select one of the three pre-set programme. The Open Window function detects an open external door or window and will turn the radiator off if it detects that it is allowing heat to escape, saving energy and money.

- Boost mode (2h at max power)
- Timer mode (configure different temperatures value for each hour and day of the week),
- Comfort mode (desired user temperature),
- Night mode, Pilot-wire mode, Antifreeze mode, Holiday mode
- Adaptive Start Control, open windows, ON/OFF button and a security lock for children.

# Iris shown on pages 110-111

Stainless Steel; 22mm cross tubes  
Suitable for a direct system, Hydronic & Electric Models  
CE/UKCA approved & certified to BS EN442.

Polished Stainless Steel.

**Stock Polished Stainless Steel: 48-72 Hours**  
Made to Order electric: Up to 3 weeks



**SAVE £45** WHEN YOU BUY OUR **CYLINDER KIT** WITH ANY TOWEL RAIL ORDER\*  
QUOTE **PROMOV3** AT TIME OF ORDER

Available in White or Chrome

Pipe centres left to right	Pipe centres from wall	Depth from wall
width - 32mm	84mm	100mm

## Stock options Polished Stainless Steel - Standard

Height (mm)	Width (mm)	Model	Watts Δt 50°C	Btu's Δt 50°C	Price Ex VAT	Price Inc VAT
DELIVERY TIMES					<b>48-72 HOURS</b>	
800	500	IRIS8050S	198	676	<b>£516.00</b>	<b>£619.20</b>
	600	IRIS8060S	233	795	<b>£562.00</b>	<b>£674.40</b>
1200	300	IRIS1230S	217	740	<b>£628.00</b>	<b>£753.60</b>
	500	IRIS1250S	314	1071	<b>£658.00</b>	<b>£789.60</b>
	600	IRIS1260S	371	1266	<b>£743.00</b>	<b>£891.60</b>

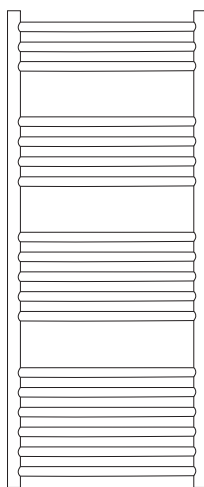

## Stock options Polished Stainless Steel - Horizontal

Height (mm)	Width (mm)	Model	Watts Δt 50°C	Btu's Δt 50°C	Price Ex VAT	Price Inc VAT
DELIVERY TIMES					<b>48-72 HOURS</b>	
600	1000	IRIS6010S	517	1764	<b>£662.00</b>	<b>£794.40</b>
800	1000	IRIS8010S	682	2327	<b>£733.00</b>	<b>£879.60</b>

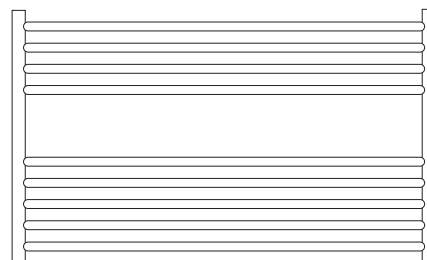

Made to order options - Standard electric

Height (mm)	Width (mm)	Model	Watts Δt 50°C	Price Ex VAT	Price Inc VAT
DELIVERY TIMES			UP TO 3 WEEKS		
800	500	IRIS8050ES	125	£716.00	£859.20
	600	IRIS8060ES	150	£762.00	£914.40
1200	300	IRIS1230ES	125	£828.00	£993.60
	500	IRIS1250ES	200	£858.00	£1,029.60
	600	IRIS1260ES	200	£943.00	£1,131.60

Supplied with standard element and powered from a switched fused spur.

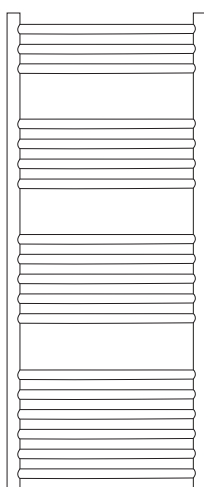

Position of element for electric models

Made to order options - Horizontal electric

Height (mm)	Width (mm)	Model	Watts Δt 50°C	Price Ex VAT	Price Inc VAT
DELIVERY TIMES			UP TO 3 WEEKS		
600	1000	IRIS6010ES	125	£862.00	£1,034.40
800	1000	IRIS8010ES	150	£933.00	£1,119.60

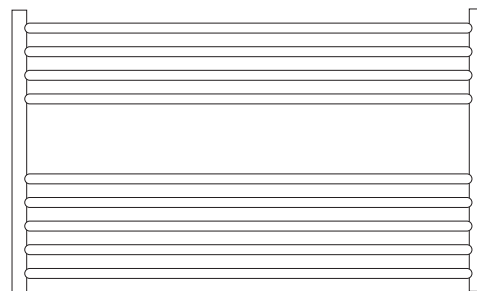

Position of element for electric models

Supplied with standard element and powered from a switched fused spur.

\*Saving based on the value of individual items when bought separately. Order any of our selected valves & matching pipe covers at the same time as your radiator; PROMOV3W (white), PROMOV3C (chrome).

# Chalfont Floor Standing page 113

Brass tubes with a steel sectional radiator  
CE/UKCA approved & certified to BS EN442.

Chrome with White Steel Radiator (main image)  
Antique Bronze with Ivory Steel Radiator (shown below)  
Antique Copper with Ivory Steel Radiator (shown below)  
Bright Nickel with White Steel Radiator (shown below).

## Stock Chrome: 48-72 Hours.

Made to Order: Up to 10 weeks Bright Nickel & Chrome Electric,  
Antique Bronze and Antique Copper.



OUR CROSSHEAD VALVES ARE THE PERFECT MATCH FOR THESE TRADITIONAL STYLED TOWEL RAILS, SEE PAGE 125 FOR MORE INFORMATION AND PRICES.

Pipe centres left to right	Pipe centres from wall	Maximum depth from wall
width - 157mm - valves	100mm	250mm

## Stock options Chrome

Height (mm)	Width (mm)	Model	Watts Δt 50°C	Btu's Δt 50°C	Chrome Ex VAT	Chrome Inc VAT
DELIVERY TIMES					48-72 HOURS	
938	675	CHAL9367	554	1890	£1,755.00	£2,106.00
1500	500	CHAL1550	738	2518	£1,925.00	£2,310.00

Made to order options

Height (mm)	Width (mm)	Model	Watts Δt 50°C	Btu's Δt 50°C	Bright Nickel Ex VAT	Bright Nickel Inc VAT	Antique Bronze Ex VAT	Antique Bronze Inc VAT	Antique Copper Ex VAT	Antique Copper Inc VAT
DELIVERY TIMES					UP TO 10 WEEKS		UP TO 10 WEEKS		UP TO 10 WEEKS	
938	675	CHAL9367	554	1890	£1,913.00	£2,295.60	£2,581.00	£3,097.20	£2,601.00	£3,121.20
1500	500	CHAL1550	738	2518	£2,125.00	£2,550.00	£2,637.00	£3,164.40	£2,707.00	£3,248.40

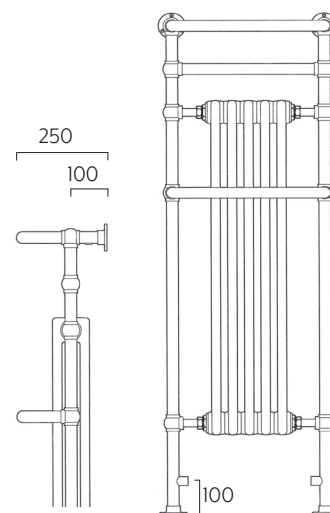

Antique Bronze



Antique Copper



Bright Nickel

Made to order options - Electric

Height (mm)	Width (mm)	Model	Watts Δt 50°C	Chrome Ex VAT	Chrome Inc VAT	
DELIVERY TIMES					UP TO 10 WEEKS	
938	675	CHAL9367EC	400	£2,005.00	£2,406.00	

Supplied with standard element and powered from a switched fused spur.

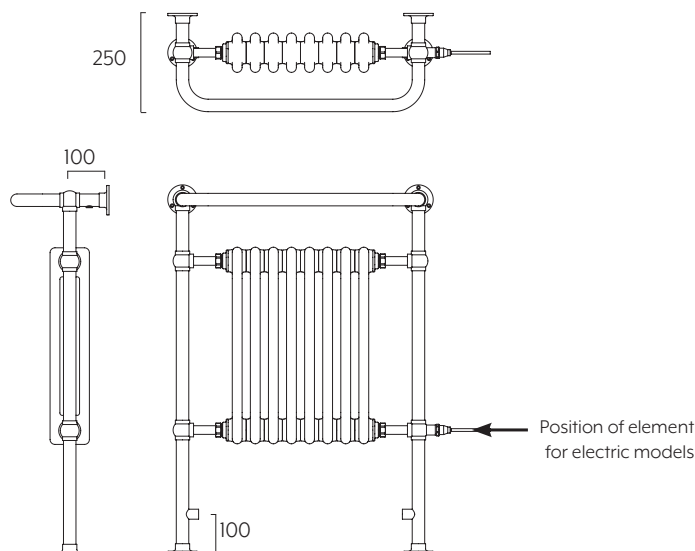

# Chalfont Wall Hung on page 113

Brass tubed wall hung design, suitable for a direct system  
CE/UKCA approved & certified to BS EN442.

Chrome (main image)  
Antique Bronze, Antique Copper & Bright Nickel (shown below).

### Stock Chrome: 48-72 Hours.

Made to Order: Up to 10 weeks Bright Nickel & Electric,  
Antique Bronze and Antique Copper.



OUR CROSSHEAD VALVES ARE THE PERFECT MATCH FOR THESE TRADITIONAL STYLED TOWEL RAILS, SEE PAGE 125 FOR MORE INFORMATION AND PRICES.

Pipe centres left to right	Pipe centre from wall	Maximum depth from wall
width - 75mm	50mm	125mm

### Stock options Chrome

Height (mm)	Width (mm)	Model	Watts Δt 50°C	Btu's Δt 50°C	Chrome Ex VAT	Chrome Inc VAT
DELIVERY TIMES					48-72 HOURS	
750	500	CHAL7550	169	577	£1,186.00	£1,423.20

Made to order options

Height (mm)	Width (mm)	Model	Watts Δt 50°C	Btu's Δt 50°C	Bright Nickel Ex VAT	Bright Nickel Inc VAT	Antique Bronze Ex VAT	Antique Bronze Inc VAT	Antique Copper Ex VAT	Antique Copper Inc VAT
DELIVERY TIMES					UP TO 10 WEEKS		UP TO 10 WEEKS		UP TO 10 WEEKS	
750	500	CHAL7550	169	577	£1,304.00	£1,564.80	£1,645.00	£1,974.00	£1,722.00	£2,066.40

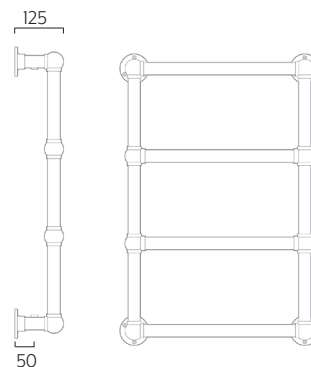

Antique Bronze

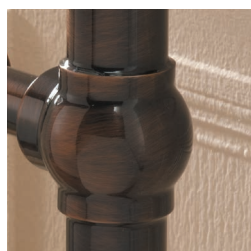

Antique Copper



Bright Nickel

Made to order options - Electric

Height (mm)	Width (mm)	Model	Watts Δt 50°C	Chrome Ex VAT	Chrome Inc VAT	Bright Nickel Ex VAT	Bright Nickel Inc VAT
DELIVERY TIMES			UP TO 10 WEEKS		UP TO 10 WEEKS		
750	500	CHAL7550E	100	£1,436.00	£1,723.20	£1,554.00	£1,864.80

Supplied with standard element and powered from a switched fused spur.

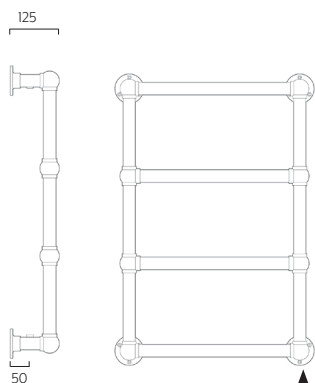

Position of element for electric models



Chalfont Electric in Chrome

# Lingfield shown on page 114

Brass tubed floor standing design, suitable for a direct system  
CE/UKCA approved & certified to BS EN442.

Chrome (main image)  
Antique Bronze  
Antique Copper  
Bright Nickel

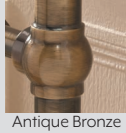

Antique Bronze

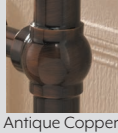

Antique Copper

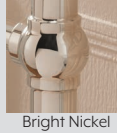

Bright Nickel

## Stock Chrome: 48-72 Hours

Made to Order: Up to 10 weeks for Bright Nickel, Antique Bronze / Copper

Pipe centres left to right	Pipe centres from wall	Maximum depth from wall
width - 147mm - valves	118mm	235mm



OUR CROSSHEAD VALVES ARE THE PERFECT MATCH FOR THESE TRADITIONAL STYLED TOWEL RAILS, SEE PAGE 125 FOR MORE INFORMATION AND PRICES.

## Stock options Chrome

Height (mm)	Width (mm)	Model	Watts Δt 50°C	Btu's Δt 50°C	Chrome Ex VAT	Chrome Inc VAT
DELIVERY TIMES					48-72 HOURS	
850	600	LING8560	439	1498	£2,561.00	£3,073.20

Made to order options

Height (mm)	Width (mm)	Model	Watts Δt 50°C	Btu's Δt 50°C	Bright Nickel Ex VAT	Bright Nickel Inc VAT	Antique Bronze Ex VAT	Antique Bronze Inc VAT	Antique Copper Ex VAT	Antique Copper Inc VAT
DELIVERY TIMES					UP TO 10 WEEKS		UP TO 10 WEEKS		UP TO 10 WEEKS	
850	600	LING8560	439	1498	£2,819.00	£3,382.80	£3,197.00	£3,836.40	£3,197.00	£3,836.40

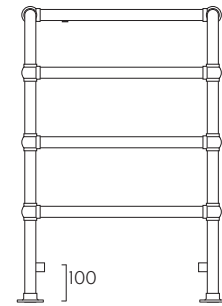
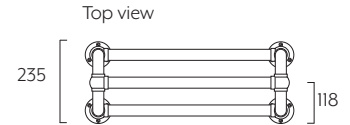

# Linton Towel Rail shown on page 115

New Colours

Steel tubes with a cast iron radiator  
CE/UKCA approved & certified to BS EN442.

Chrome steel tubes, cast iron sections available in 24 RAL colours,  
(please see page 197 for colour options)

Made to Order: Up to 7 weeks



OUR CROSSHEAD VALVES ARE THE PERFECT MATCH FOR THESE TRADITIONAL STYLED TOWEL RAILS, SEE PAGE 125 FOR MORE INFORMATION AND PRICES.

Pipe centres left to right	Pipe centres from wall	Depth from wall
width - 122mm (+/- 2mm) - valves	140mm	315mm

Made to order options

Height (mm)	Width (mm)	Model	Watts Δt 50°C	Btu's Δt 50°C	Chrome/Colours Ex VAT	Chrome/Colours Inc VAT
DELIVERY TIMES					UP TO 7 WEEKS	
900	490	LINTR904903C	357	1218	£1,147.00	£1,376.40
	650	LINTR906505C	595	2030	£1,452.00	£1,742.40
	820	LINTR908207C	834	2846	£1,810.00	£2,172.00
1000	490	LINTR104903C	416	1419	£1,172.00	£1,406.40
	650	LINTR106505C	694	2368	£1,483.00	£1,779.60
1200	490	LINTR124903C	619	2112	£1,411.00	£1,693.20
	650	LINTR126505C	1031	3518	£1,786.00	£2,143.20

23 RAL colours are shown on page 197

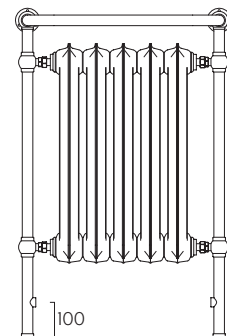
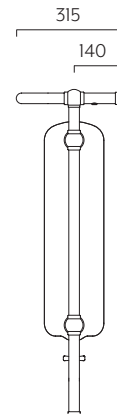



# Index

<b>A</b>	<b>Pages</b>
Aluminium Accessories	177
Aluminium, Sectional	62-73, 176-187
Ancona®	6-29, 128-149
Ancona® Bare Metal Lacquer	116-17, 136-137, 140-141
Ancona® Bench seat	28-29, 146-147
Ancona® Curved	30, 148
Ancona® Electric	31, 149
Ancona® Galvanised	26-27, 144-145
Ancona® Made To order	18-27, 138-145
Ancona® Stock	8-17, 128-137
Ancona® Feature Finishes	14-15, 130-135
Aston	78-79, 190
Athena	58-59, 172
Athena, BDO	92, 200
Athena Towel Rail	93, 200
<b>B</b>	
BDO Athena	92, 200
BDO Poll	104, 209
BDO Sitar	103, 208
BDO Step	90, 198
Black & Brass TRV	124
Blues	112, 206
Bohemia	86-87, 195
<b>C</b>	
Ceramica Collection	34-35, 150
Canto	46, 156
Cast Iron Radiators	74-87, 188-195
Chalfont	113, 214-215
Chalfont Electric	113, 214-215
Crosshead Valve	125
Cylinder Valve	125
<b>D</b>	
Designer Radiators	34-63, 150-175
Dual Fuel Elements & Valve	116-117
<b>E</b>	
Echo	95, 202
Echo Electric	95, 202
Electric Elements	116-117
Ellipsis	48-49, 158-161
Ellipsis Stainless Steel	47, 157
Ellipsis Towel Rail	101, 207

End panels (Vip, Oscar)	177, 179, 181
<b>F</b>	
Feature Finishes	14-15, 130-135
<b>G</b>	
Griffin	99, 205
Griffin Electric	99, 205
<b>H</b>	
Halo	62-63, 173
<b>I</b>	
Immagina	57, 171
Ideal Corner TRV	120
Ideal TRV	121
Iris	110-111, 213
Iris Electric	110-111, 213
Iseo	40-41, 153
<b>L</b>	
Ledbury	76-77, 189
Lingfield	114, 216
Linton	82-83, 191
Linton Towel Rail	115, 216
Lupin	108-109, 212
Lupin Electric	108-109, 212
<b>M</b>	
Mini Cube Valve	125
Mix	72-73, 186-187
<b>N</b>	
Niro	38-39, 152
<b>O</b>	
Odolo	44-45, 155
Oscar	68-69, 180-181
<b>P</b>	
Painted Valves	119
Piano	54-55, 168-169
Piano Lato	97, 202
Piano Towel Rail	96, 203
Pipe Covers	119, 126
Pistol TRV	119, 124
Poll	105, 210
Poll Electric	105, 210
Poll, BDO	104, 209
Poppy	106-107, 211
Poppy Electric	106-107, 211

Pulsar	100, 206
<b>Q</b>	
Quadre	98, 204
<b>R</b>	
Relax	60-61, 174-175
Relax Bagno	94, 201
<b>S</b>	
Sax	52-53, 166-167
Sebino	42-43, 154
Sectional Aluminium	64-73, 176-187
Shrouds	119, 126
Sitar	50-51, 162-165
Sitar Lato	102, 208
Sitar, BDO	103, 208
Steel Multi Column	8-31, 128-149
Step	91, 199
Step Electric	91, 199
Step, BDO	90, 198
Standard wall brackets	129/131/142
<b>T</b>	
Telford	80-81, 192-193
Torré	36-37, 151
Towel Rail Section	88-115, 198-216
T-Pieces	117
Trieste	84-85, 194
<b>V</b>	
Valve Section	118-125
Vintage TRV	122
Vintage XL TRV	123
Vip	66-67, 178-179
Vox	70-71, 184-185
<b>W</b>	
Water Lily	56, 170
3 Style valve	125

## Convactor Radiators

Our convactor ranges, Trench and Mini, are still available to order. Full details can be found on our website, [theradiatorcompany.co.uk](http://theradiatorcompany.co.uk).

# Helpful Advice

## Made to Order

We pride ourselves on having the widest range of sizes, options, colours, and accessories so that you have literally thousands of options to choose from. This means that you can have almost any radiator made to order so that it perfectly suits the space you have available, your interior design and also match your heat requirements.

## Colour Options

Many of our designs are available in a large selection of RAL colours (188 internationally recognised paint colours) and Special Finishes. If you would like a copy of our RAL or Special Finish chart please contact us on **01342 302250**. Please note that due to the printing process and manufacturing tolerances, the colour (including white) of a finished radiator may vary slightly from the colours represented in the brochure and from one colour group to another, as well as from our Special Finish & RAL charts. It should also be noted that if the same type of radiators are ordered and produced, they may also differ in finished colour from any previously ordered.

## Stock

To provide the best possible service, we hold the most popular sizes of white and chrome models in stock. So if you need quick delivery, look in the technical section for models listed with **bold** prices; these can usually be delivered within 48-72 hours.

## How much heat?

We always recommend you choose radiators with a higher output than required, as you can always turn them down & have the reassurance of additional heat in really cold spells.

## How is heat output measured?

There are two recognised measurements for heat output; BTU's (British Thermal Unit) and Watts. Within this brochure you will find both listed in the technical section by each radiator.

## Delta T's

The heat output of a radiator is established using a calculation called a delta T ( $\Delta T$ ), based on the desired room temperature of 20°C and boiler flow and return temperatures; European standards use delta T50°C as a measurement, this is based on a boiler flow temperature of 80°C and a return of 60°C ( $80^\circ\text{C} + 60^\circ\text{C} \div 2 - 20^\circ\text{C} = 50^\circ\text{C}$ ). Some systems using renewable energy sources may have different flow and returns and therefore different delta T's (e.g.  $60^\circ\text{C}/40^\circ\text{C} = \text{delta T}30^\circ\text{C}$ ). If you require outputs based on alternative delta's please contact us on **01342 302250**.

## BS EN442

Our radiators are produced & outputs measured according to BS EN442. This standard uses delta T50 to provide a consistent and comparative output measurement. Some installers may still use the old delta T60 as a measure of output, to convert use the following correction factors;  $\Delta T50$  to  $\Delta T60$  multiply by 1.267,  $\Delta T60$  to  $\Delta T50$  multiply by 0.781.

## How can I find out what heat outputs I need?

Your installer should be able to confirm the exact requirements for each of your rooms, but you can also visit our website ([theradiatorcompany.co.uk](http://theradiatorcompany.co.uk)) and use our online heat calculator or use the following simple calculation as a guide;

1. Find the volume of your room in cubic feet = height x width x length (To convert cubic metres into cubic feet multiply the total figure by 35.31).
2. Multiply the volume by 6 to find the BTU requirement. If you need to know the Watts equivalent, divide your BTU by 3.412.

For example:

A bathroom 6'x8' with 8' ceilings = a volume of 384 cubic feet multiply by 6 = 2304 Btu's

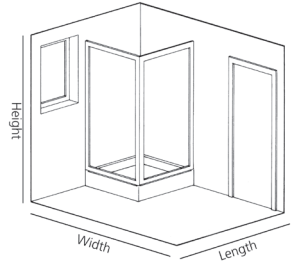

You may need more than 1 radiator in order to ensure an even distribution of heat in a large room, if so divide the required output by the total number of radiators you could sensibly place in the room.

e.g. a lounge 14' x 18' x 8' ceilings = 12096 Btu's.

Two radiators would require an output of = 6048 BTU's each, 3 radiators = 4032 BTU's each

## Do different designs affect output?

By altering the size, shape or number of tubes or columns in a radiator you can adjust the output achieved, as this adds or subtracts surface area, the main contributor to heat output. For example, the multiple columns of our Ancona® range provide huge flexibility in achieving the right output in a limited space.



## Single or double radiators

Using models with additional rows of tubes or multiple columns maximises heat output within the same wall space.

Our Water Lily design comes in single or double versions, as an example of comparative heat outputs:

*Water Lily single 2020mm x 312mm = 2238 BTU's*

*Water Lily double 2020mm x 312mm = 3180 BTU's*



## Horizontal or Vertical;

Many of our designs are available in horizontal or vertical options which means you can maximise the use of ceiling heights and long low spaces, without losing output.

# How to order

## Order your radiator in seven easy steps

- 1. Confirm your heat output requirements for the room where you need the radiator or towel rail;** this ensures the radiators you choose will deliver the heat output you need. Use the BTU (heat output calculator) on our website [theradiatorcompany.co.uk](http://theradiatorcompany.co.uk) then decide how many radiators you need for the relevant room; discuss this and positions with your installer if needed.
- 2. Choose your design;** our range has everything from traditional cast iron to modern feature radiators, even an environmentally friendly aluminium range, with an extensive choice of sizes, colours & outputs.
- 3. Select a size that matches the heat output requirement;** outputs are shown in our technical section & will help you & your installer to find the best match for your needs.
- 4. Choose the colour you want;** with over 200 colours & special finishes you are able to match your colour scheme or introduce an accent colour to create a striking feature.
- 5. Find a valve to complete the look;** Choose from our wide selection of valves and add any accessories that complement your choice.
- 6. Order from your nearest showroom or merchant** to find your nearest branch call us on **01342 302250** or visit [theradiatorcompany.co.uk](http://theradiatorcompany.co.uk)
- 7. Order online from our website [theradiatorcompany.co.uk](http://theradiatorcompany.co.uk)**

*For help in choosing a sectional radiator (modular radiators that can be built by section to achieve a size and/or output requirement), please visit our website to use one of our online radiator builders for Ancona® Steel Multi Column, Cast Iron and Sectional Aluminium.*

## Our Product Range

- All our radiators are produced and outputs measured in accordance with BS EN442 and as such are CE/UKCA approved.
- Radiators are supplied with BOE connections as standard unless otherwise stated. B2 underneath connections can be supplied with selected models. Full technical details can be found from pages 128 to 216 and all details are in accordance with our factory or manufacturing partner's terms of reference at the time of going to print.
- Due to the excessively corrosive nature of chlorine, we do not recommend that radiators & towel rails are placed in swimming pool environments. In addition, radiators should not be located in areas that have long term exposure to high levels of moisture without suitable ventilation.
- When commissioning any radiator (including aluminium) on an indirect/closed system, we recommend using a suitable mixed metal inhibitor in suitable quantities to protect against scale & corrosion. We can provide the water content of our radiators if required to help the installer calculate this if needed.

## Electric / Dual Fuel

Selected towel rails can be converted to work as dual fuel models. An element and T-piece are needed to adapt the towel rail; your installer will need to be aware if you wish to do this in order to adjust pipe centres accordingly. See pages 116 - 117 for our range of elements. If a towel rail is suitable for dual fuel, it will be noted on the product technical page.

## Pipe Centres

We endeavour to ensure all pipe centres are correct, however manufacturing tolerances must be considered. Therefore we strongly recommend that pipe work is not altered or adjusted until your new radiator or towel rail is delivered. The Radiator Company will not accept any responsibility for claims resulting from incorrect pipe centres.

## Delta T's

The heat output of a radiator is established using a calculation called a delta T ( $\Delta T$ ), based on a desired room temperature of 20°C and boiler flow & return temperatures; European standards use delta T50°C as a measurement, this is based on a boiler flow temperature of 80°C and a return of 60°C (80°C + 60°C ÷ 2 - 20°C=50°C). Some systems using renewable energy sources may have different flow and returns and therefore different delta T's (e.g 60°C/40°C = delta T30°C). If you require outputs based on alternative delta's please contact us on **01342 302250**.

## Delivery

Please note that many of our factories close for 2-4 weeks during the holiday periods of July/August and December. This may extend the delivery period quoted for non stock made to order items ordered during July/August & December/January. We will confirm the expected delivery date on our order acknowledgement at the time of order. Unfortunately, delivery to Scotland / Offshore Islands may take longer due to the distances involved. Deliveries will be made to the nearest hard standing area.

## Systems

All radiators and towel rails featured in this brochure are suitable for indirect/closed systems that comply with 'BS5449, section 1 forced circulation hot water systems'. Systems running with low pressures (under 1 Bar), microbore pipework or modern boilers with modulating pumps, may experience flow and heating issues if not accounted for in the system design which could result in radiators not heating fully or noisy pipework.

Direct heating systems use your hot water supply to heat a radiator; usually this will occur in a bathroom. If you have any radiators or towel rails linked to a direct system they should be made from either stainless steel or brass to avoid rusting and contaminating the hot water supply. However it should be noted that these radiators are not suitable for Direct systems fitted with a water softener.

## Powder coat finishes and Painted cast iron

It should be noted that due to the production process colours can vary by +/- 5 to 10% from samples provided and between radiators ordered in the same colour at different times.

All painted cast iron radiators will be checked and tested prior to despatch. Care must be taken when handling and joining painted cast iron radiators on-site to avoid damaging the finish. Cast iron radiators will be supplied with a small bottle of touch up paint in case of damage to the finish during installation, however, it should be noted that this may vary slightly from the standard powder coat finish. As a result of the casting process, cast iron radiators have a rough surface finish with small imperfections which will show after the painting process.

## Terms & Conditions

For a copy of The Radiator Company full Terms & Conditions please call our Customer Services department on **01342 302250** or visit [theradiatorcompany.co.uk](http://theradiatorcompany.co.uk)



Design | Choice | Service

[theradiatorcompany.co.uk](http://theradiatorcompany.co.uk)

Tel. 01342 302250 Fax. 01342 302260 [sales@theradiatorcompany.co.uk](mailto:sales@theradiatorcompany.co.uk)