

**impey**

MERCHANT AND TRADE WETROOM GUIDE | JANUARY 2023

## Contents

Why choose a wetroom?	4
A perfect wetroom in four simple steps	6
Wetroom Floor Formers	8
Waterproofing	14
Underfloor Heating	16
Drainage	18
Wetroom Screens	22
Specifications	28
Contact Us	39



**Impey. The UK's market-leading wetroom brand.**

As a dedicated wetroom manufacturer, our focus at Impey is on technical excellence and unbeatable product quality. Creating practical and innovative solutions for every possible situation.

Part of the Coram Group

# Why choose a wetroom?

Wetrooms add luxury, style and visual appeal to a home, and provide the perfect showering space even in the smallest areas. They create a sense of space, dedicated to luxury and relaxation plus practical level access to the showering area.

Wetrooms can be easily installed anywhere, from a ground floor space to a loft conversion, and their walk-in or walk-through design makes them accessible to everyone. They're easy to clean and maintain, and with Impey WaterGuard your walls and floors are 100% watertight with a lifetime guarantee.

The perfect leak-free, risk-free solution, for any location.



For details please visit our website.



# A perfect wetroom in four simple steps

As the UK's leading wetroom manufacturer we pride ourselves on simple, beautiful solutions born through decades of innovation and product refinement. This has resulted in a wetroom system that is the easiest and quickest to install.

Begin by following these four simple steps.

## Step 1. Floor Former

First select the floor former that's right for the situation. There are a range of 6 solutions to choose from in the Impey range.

## Step 2. Waterproofing

We've made creating a perfect waterproof and leak-free environment simple with our WaterGuard technology, designed and tested for use on both floors and walls.

## Step 3. Underfloor Heating

A highly recommended finishing touch to add real comfort to your wetroom. Aqua-Mat is a highly efficient underfloor heating system fitted under the tiles.

## Step 4. Wetroom Screens

Complete your wetroom with a stylish glass wetroom panel. Wetroom panels help restrict water escaping the showering area.



# Wetroom Floor Formers

Aqua-Dec floor formers are made to the highest level of care and detail - through streamlined manufacturing process and cutting edge technology - we ensure all products are of unparalleled quality and performance.

## Aqua-Dec EasyFit™

The UK's most popular specified and strongest wetroom floor former available. Made for use with wooden floors with joists and concrete floors.

## Aqua-Grade™ and Aqua-Grade Linear™

The quick and easy way to create the perfect gradient for new pour concrete floors.

## Aqua-Dec Linear 2™

Features two gradients to assist flow to the linear drain. The Aqua-Dec Linear 2 is the perfect solution for corner or alcove settings, with no need for diagonal cuts in the tiles.

## Aqua-Dec Linear 3™

3 way uniformed fall featuring an 800mm drain with all sizes. The Aqua-Dec Linear 3 can be fitted not only in corner and alcove settings but also in a walk-through environment.

## Aqua-Dec Linear 4™

Features four gradients to assist flow to the linear drain. The Aqua-Dec Linear 4 offers a unique appearance and is incredibly versatile. The Linear 4 can be fitted in a corner, alcove or walk-through setting.

All Impey Aqua-Dec floor formers are for a tile installation only.

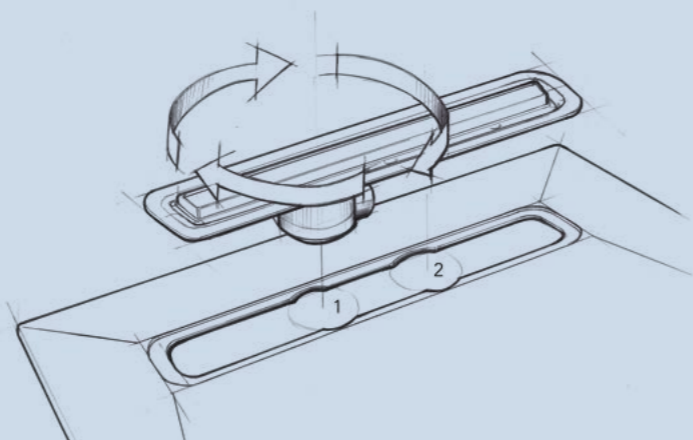
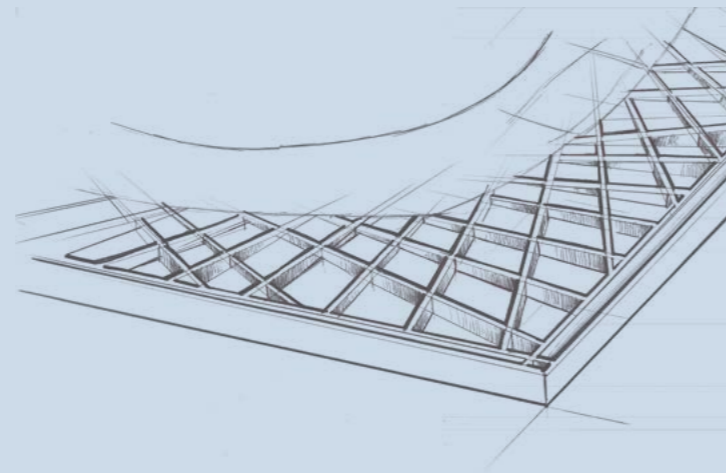
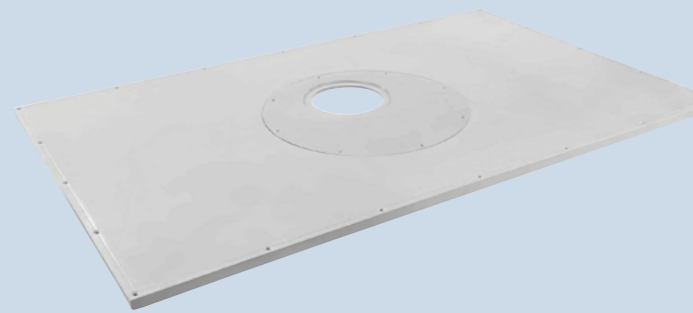

Over **500,000** Impey wetrooms installed throughout the UK and Europe

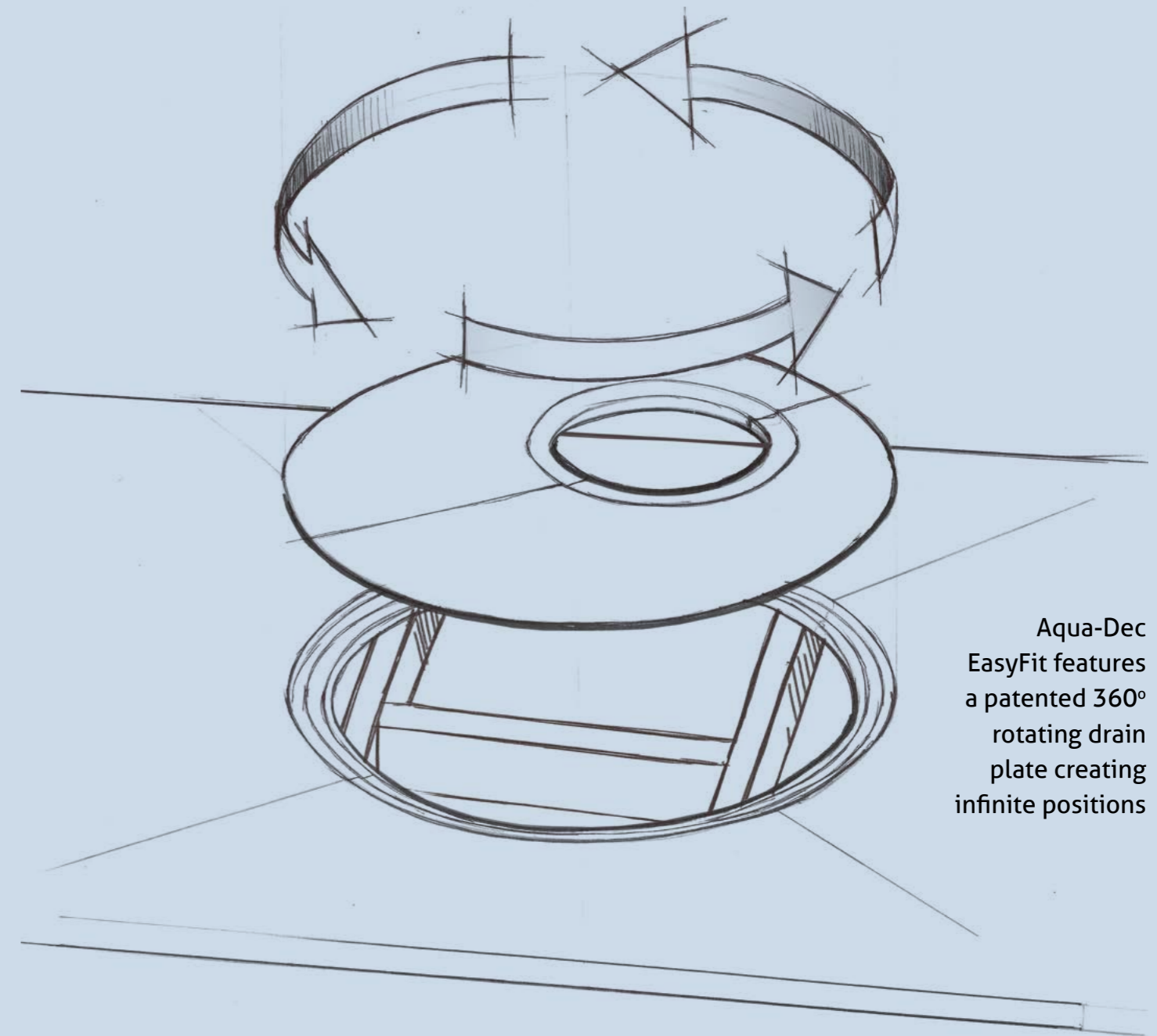

Aqua-Dec EasyFit features a patented 360° rotating drain plate creating infinite positions



### Lifetime Watertight Guarantee

Install our WaterGuard™ system with any Aqua-Dec floor former and receive our Lifetime Watertight Guarantee.

For details please visit our website.



All Impey Aqua-Dec floor formers are designed and made in the UK

## Aqua-Dec EasyFit™

The UK's most popular specified wetroom floor former - for all floor types

Aqua-Dec EasyFit floor formers can be simply installed on wooden floors or concrete.

The Aqua-Dec EasyFit is just 22mm thick at the outer edge, which is the same depth as a standard floorboard. This floor former features a revolutionary patented 360° rotating plate to circumnavigate any underfloor obstructions.

INSTALLATION VIDEO GUIDE  
SCAN BELOW TO WATCH



Trimmable underside cellular structure of the Aqua-Dec EasyFit

### Complete range of sizes

Available in twelve sizes from a compact 800mm square to 1850 x 900mm - to suit any floor space.

### No underfloor boarding required

The floor former is fitted direct to the joist which significantly reduces installation time\*.

### Easily trimmable

Can be cut to help with installation constraints, e.g. bespoke walls or around soil pipes.

### Installation made easier

The drain plate has three locating rings, to provide a superior hold between the floor former and the rotating drain plate.



Floor joists and underfloor pipework regularly interfere with floor formers that have a fixed drain aperture.



Aqua-Dec EasyFit patented rotating drain plate solves this problem by rotating the centre drain disc to a different position.

### Flexible with all flooring

Easily fitted on wood and concrete floors as the underside spoke pattern provides strength and the ideal surface for bonding to concrete.

### Lighter and stronger

Made from strong but lightweight material, Aqua-Dec EasyFit is designed to bear loads of up to 300kg (47 stone).

### Supplied complete with drainage

Aqua-Dec EasyFit floor formers are supplied with a standard UTT01/H tiled floor gully and 'Slot' grate design. Alternative drainage solutions can also be specified.

### Award winning design

Winner at Build-It Awards 2019 for 'Best plumbing or drainage product'.



Install our WaterGuard™ system with any Aqua-Dec floor former and receive our Lifetime Watertight Guarantee.

For details please visit our website.

\*When joists are no more than 415mm centres.

## Aqua-Grade™ and Aqua-Grade Linear™

Recommended for new pour concrete floors

Aqua-Grade provides a quick and easy alternative way of creating the perfect gradient for new pour solid floors. Colour coded modular sections click together to form the matrix – which you then simply fill with screed, reducing installation time by up to 50%. Available in square grate and linear grate versions.

INSTALLATION VIDEO GUIDE  
SCAN BELOW TO WATCH

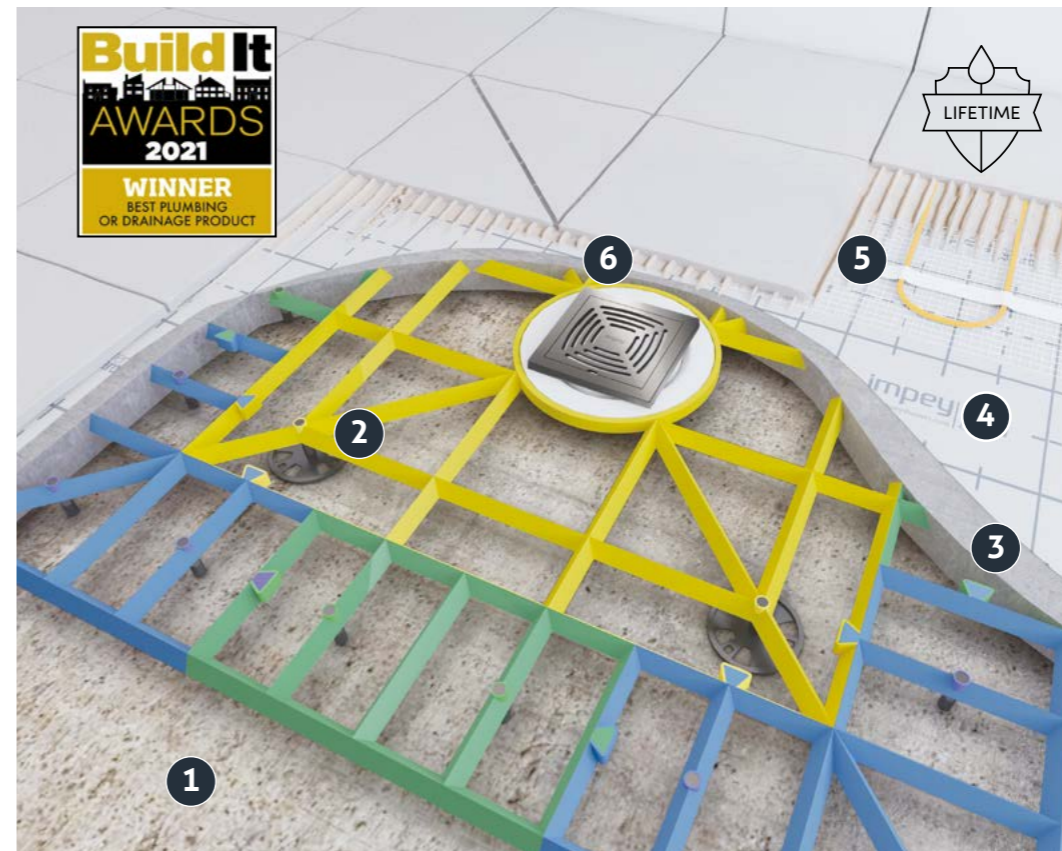

The six elements to creating a wetroom with Impey Aqua-Grade

- 1 Floor substrate
- 2 Aqua-Grade
- 3 Screed fill
- 4 WaterGuard tanking kit
- 5 Aqua-Mat underfloor heating
- 6 Impey drain

### The possibilities are endless...

The Aqua-Grade modular system enables you to build the perfect wetroom floor on any concrete floor, whatever its specific requirements. Each section has the exact gradient built in, so a consistent fall is always achieved - eliminating pooling and saving time. Aqua-Grade is designed to be installed directly onto the sub-floor and is an ideal solution for uneven surfaces as it can be easily levelled by adjusting the individual feet to provide the perfect platform.

Aqua-Grade is available in standard sizes.

### Aqua-Grade



### Aqua-Grade Linear



Aqua-Grade floor formers are supplied with the recommended drain in various square or linear format.

# Aqua-Dec Linear

The UK's market-leading Linear drainage floor former, Aqua-Dec Linear, is available in three models in varying sizes to suit your space requirements and choice.

**Aqua-Dec Linear floor former overview:**

- 22mm thick, equal to most floor boards
- Offset waste position to give multiple drain locations
- High flow rates of up to 40 litres per minute
- Adjustable drain outlet position which can be rotated up to 180°
- Linear Drain with Brushed Stainless Steel drain top as standard (tiled insert available)
- Suitable for concrete and wooden installations
- Full install guides, fixings and screws supplied - install straight out of the box
- Full installation Technical support

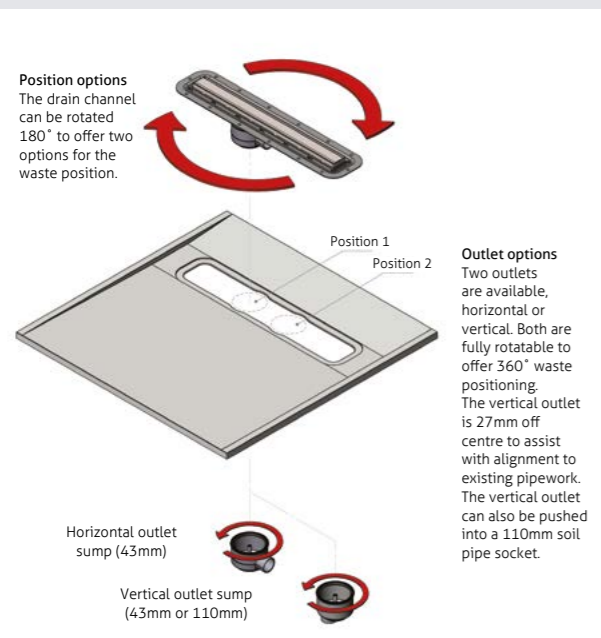

## Aqua-Dec Linear 2™

Features two gradients to assist flow to the linear drain

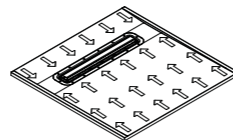

The construction of the Linear 2 wetroom floor former means there is no need to mitre the tiles in the corners. High-quality stainless steel inserts are available to finish the tile edges, which can be either flush to a wall or covered with a wetroom glass panel. The Aqua-Dec Linear 2 is 22mm thick and can be installed on timber or concrete floors, providing flow rates of 40l/min. The Aqua-Dec Linear 2 is supplied with a gravity waste.

**Key Features of Aqua-Dec Linear 2**



- 2 gradients leading to the drain
- No diagonal tile cuts
- 600mm linear drain top
- Ideal for alcove installations
- Linear drain 244mm from the wall
- 3 sizes available
- Not trimmable



Full Technical and Product support available, please call 01460 256080

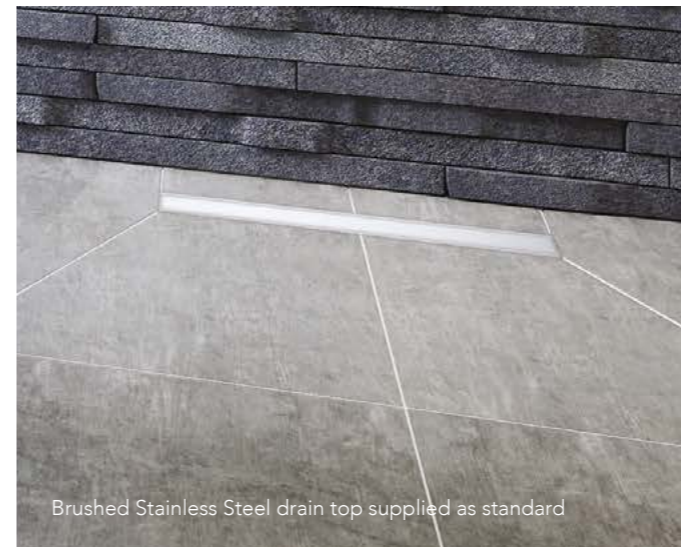

## Aqua-Dec Linear 3™

Features three gradients to assist flow to the linear drain

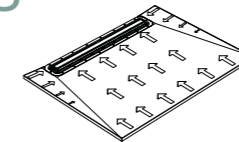

Unlike the Aqua-Dec Linear 2 and 4, the Aqua-Dec Linear 3 can be cut to length within 75mm each side of the drain edge to assist with alcove spaces. Ideal for a minimal 'barely there' look with a compatible walk-through screen. The Aqua-Dec Linear 3 is 22mm thick and can be installed on timber or concrete floors, providing flow rates of 40l/min. The Aqua-Dec Linear 3 is supplied with a gravity waste.

**Key Features of Aqua-Dec Linear 3**



- 3 gradients leading to the drain
- 2 diagonal tile cuts
- 800mm linear drain top
- Ideal for walk-through installations
- Linear drain 50mm from the wall
- 5 sizes available
- Trimmable up to 75mm from central drain



For details on Impey's Lifetime Watertight Guarantee, please visit our website.



## Aqua-Dec Linear 4™

Features four gradients to assist flow to the linear drain

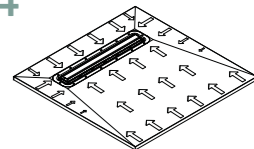

The style of the floor former, with 4 gradients leading down to the drain, draws your eye to the Linear Drain Top and provides a real statement. The broad range of sizes, 2 drainage widths of 600mm and 800mm and balanced design makes this the most versatile Linear floor former. The Aqua-Dec Linear 4 is 22mm thick and can be installed on timber or concrete floors, providing flow rates of 40l/min. The Aqua-Dec Linear 4 is supplied with a gravity waste.

**Key Features of Aqua-Dec Linear 4**



- 4 gradients leading to the drain
- 4 diagonal tile cuts
- 600 or 800mm linear drain tops
- The most versatile Linear option, compatible with walk-through, walk-in, corner and alcove spaces
- Linear drain 194mm from the wall
- 6 sizes available
- Not trimmable



# Waterproofing

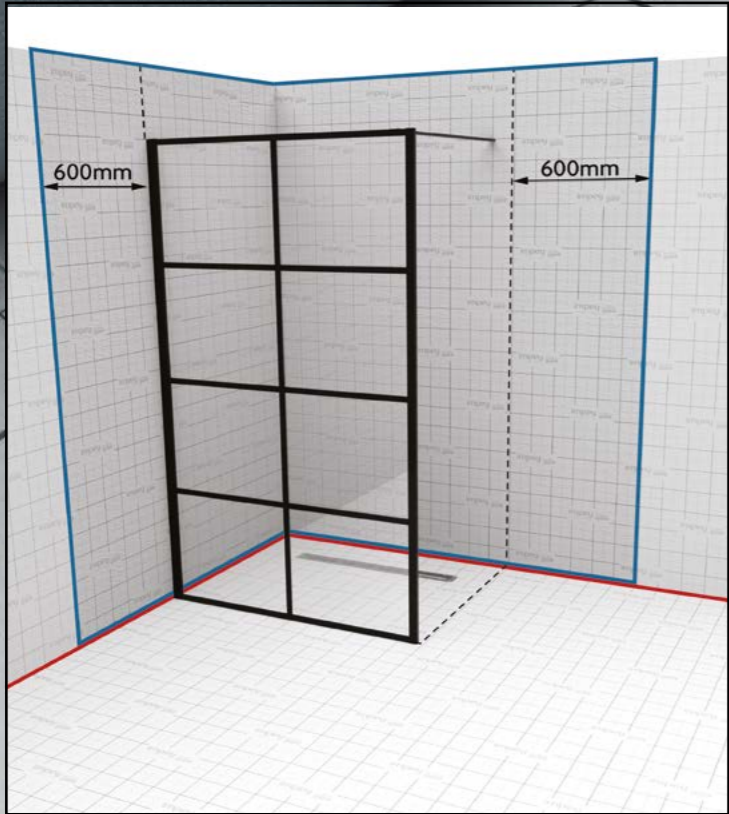

## WATERPROOF ZONING GUIDE

### Mandatory requirement

> **Red zone coverage** - The entire wetroom floor **MUST** be tanked with WaterGuard to qualify for our lifetime guarantee.

### Recommended

> **Red and Blue zone coverage** - The entire floor and walls immediately inside the wet area and extending 600mm beyond should be tanked to stop any water ingress into walls.

### Highly recommended

> **Complete coverage** - WaterGuard tanking throughout the entire wetroom (floors and walls) will create a seamless impenetrable wetroom, providing heat and sound insulation and decoupling throughout.

## Impey WaterGuard™

INSTALLATION VIDEO GUIDE  
SCAN BELOW TO WATCH



### Essential requirement for the wetroom

WaterGuard is a 1mm thick, flexible waterproofing membrane. The complete wetroom sealing solution - not just for floors but also for walls. When correctly installed across the entirety of a wetroom floor, it provides an impenetrable barrier against leaks, guaranteed for life. WaterGuard is the perfect application for waterproofing walls, tested for use on Plasterboard, Cementboard and Plyboard. WaterGuard can safely support vertical loads of 30kg/m<sup>2</sup>.

This unique system provides the ultimate watertight wetroom with its market-leading membrane design. WaterGuard is fully compatible with all Impey products and is fully compatible to use with Aqua-Mat underfloor heating. Adding WaterGuard to your wetroom gives you the peace of mind with Impey's Lifetime Watertight Guarantee.

Image shows 5m<sup>2</sup>  
WaterGuard Kit for floors



### Features:

Complete waterproof solution for floors and walls including pre-made corners

Butyl rubber backed self-adhesive sealing membrane supplied on a roll

Can tile directly after laying

Polypropylene fleece

Can be used with epoxy and solvent based sealers

Highly elastic de-coupling properties

Maximum wall load bearing 30kg/m<sup>2</sup>

Can withstand temperatures of 60°C

### Benefits:

Everything you will need to tank your wetroom, saving time and cost

A clean material which is easy to handle and very quick to apply with no curing time

Reduces installation time dramatically

Provides an excellent bond with tile adhesive

A reliable membrane to use in all situations

No need to buy an additional decoupler

Works well with heavy wall tiles

Compatible with Impey Aqua-Mat underfloor heating



Install our WaterGuard™ system with any Aqua-Dec floor former and receive our Lifetime Watertight Guarantee. For details please visit our website.



# Underfloor Heating



## | Aqua-Mat™

Increased comfort and faster drying time in the wetroom

Impey's Aqua-Mat underfloor heating is the finishing touch to make the most of your wetroom. Aqua-Mat offers unrivalled warmth, exceptionally fast drying times, and complete comfort underfoot. Aqua-Mat is 100% compatible with all Impey wetroom products.

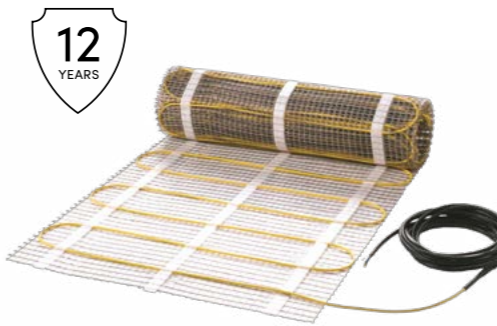

The finishing touch to make the most of your new wetroom. Impey Aqua-Mat underfloor heating is fully compatible with both WaterGuard membrane systems and the complete range of Impey wetroom floor formers. Manufactured to the most stringent of European standards with highly efficient running costs, Aqua-Mat offers unrivalled warmth, exceptionally fast wetroom drying times and complete comfort underfoot.

- Strong self-adhesive mesh
- Only 4mm in depth
- 100% aluminium earth sheath
- 100% compatible with Impey floor formers
- Twin Conductor
- 12 year warranty
- Available in:
  - 100W for concrete and timber flooring
  - 150W for concrete subfloors

## | Thermostats

Now with touch screen technology



### DEVreg Touch

For control with just a simple touch, the DEVreg Touch is an easy to use yet sophisticated looking combined thermostat timer. A clean, sharp design and a sensitive touch screen makes control of your floor heating accurate and effortless. The thermostat has built-in intelligence to automatically calculate the pre-heat time required to give you a warm floor exactly when you want and keeping running costs to a absolute minimum.

#### Features:

- 2" Backlit touch screen
- 7 day programmable
- Simple 7 step set up wizard
- Both floor and air sensor
- Reduce energy waste by up to 12%
- 5 year non quibble warranty

# Drainage



Shortlisted:  
Best plumbing  
and drainage  
product  
Build-It Awards  
2020

## Gravity Drainage Supplied as Standard

Aqua-Dec EasyFit, Aqua-Grade and Aqua-Dec Linear floor former options are supplied with a gravity waste with a horizontal outlet (vertical outlet available on request).

The Gravity Drain is the most common drain type to be used. Compatible with all Aqua-Dec floor formers within the existing floor structure or easily incorporated into a new build. All drains have been specifically designed to secure the WaterGuard membrane into place using a clamp, guaranteeing a secure watertight seal at the drainage point. The patented height adjustment technology allows for a variance of 6 - 26mm in tile depths.

The Gravity Drain for Aqua-Dec EasyFit has a flow rate of up to 36l/min, depending on drain top chosen. The Gravity Drain for Aqua-Dec Linear range is up to 39l/min, depending on drain top chosen. Included with this drain option is a specially designed hook and removable bucket, allowing for easy cleaning. The Gravity Drain features a 50mm water seal to prevent odours escaping from the drainage system and feature a 43mm solvent weld pipe connection.

### Features:

- Gravity fed
- 100% WaterGuard compatible
- Laser cut high grade stainless steel
- Removable components for easy cleaning
- Complements Impey wetroom screen range
- Flush fitting to floor surface
- Patented telescopic height adjustment technology (6 - 26mm or 14 - 24mm depending on drain top)
- Easily handles high flow rates from power showers
- 50mm water seal
- Long lasting finish
- 43mm solvent weld pipe connection
- Available with horizontal or vertical outlet



## Alternative Square Drainage

Drainage solutions for various wetrooms spaces and installation scenarios are available to purchase. In some situations, a certain drain type will be required due to the setting it is being placed in.

Slim+ and Pumped Drainage are compatible with Aqua-Dec EasyFit and Aqua-Grade at an additional charge.



### Slim+ Waste

At just 40mm deep, the Slim+ Drain is the most compact gravity waste on the market, designed to reduce the overall depth of the waste. Manufactured with a bi-injected pre-assembled seal, it is completely leak-proof with no tolerance for movement and less single components. The new smart membrane technology means no odours escape the drainage system, no back-siphoning, it eliminates noises in the pipes, it creates natural ventilation within the pipes as well as ease to remove and clean. The new hair trap has been designed to not impact the membrane when removed providing extra efficiency. Both the smart membrane technology and the new hair trap can be retro-fitted to existing models.



### Pumped Waste

The Pumped Drain is the ideal solution for unbreachable floors as it evades any limitations that a floor structure may bring. The Pumped Drain must be used with a shower waste pump to discharge showering water in areas gravity drainage is not an option, and is fully compatible with Whale pumps.

## Whale Shower Waste Pumps

Whale Shower Waste Pumps are wall mounted systems and can easily be concealed within a vanity unit, or cupboard up to 2m away from the shower drain. **Whale shower waste pumps are fully compatible with Impey's Pumped Waste.**

Both options are fully automated with shower control and have been designed to minimise suction noise at drain.



### Instant Match Premium

The choice of shower waste pump for showers with flow rates not exceeding, or regulated up to 12l/min. Whale's quietest shower drainage pump to date built on 20 years of experience with over 300,000 kits installed throughout the UK.



### Dry Deck 20

When you want a shower waste pump that can handle a bit more volume, the Dry Deck 20 is suitable for showers with a flow rate of up to 20l/min. Designed to minimise drainage suction noise by precisely matching the pump flow rate to the shower flow rate.

For support and advice on Whale Shower Waste Pumps, please contact our Technical Team.

## NEW Tiled Insert for Aqua-Dec EasyFit™

Design and engineered to work directly with the award-winning Aqua-Dec EasyFit™ wetroom floor former, our Design team took the opportunity to refine some of the existing drainage components.

As with every Impey wetroom product, the focus was around ease of installation and ensuring a seamless finish for every tiled wetroom.



### Tiling Aid

- Easy to mark out tile cuts, using intergrated central crosshair ribs
- Tile height indication
- Provides a consistent edge for grouting
- Prevents any debris falling down the drain



### Quad Tiling Frame Base

- Consistent grout lines every time
- Impact tested
- Flow rate of up to 33l/min



### Quad Height Adjustment

- Patented telescopic technology
- 10mm adjustment range (14mm - 24mm)
- Suitable for tiles up to 10mm
- Fine adjustment after tiling

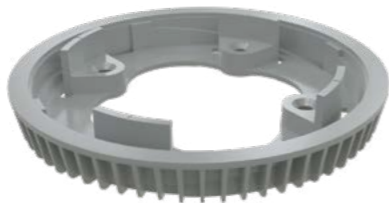

### Quad WaterGuard Clamp

- Specifically designed for WaterGuard
- Provides a water tight seal with WaterGuard



### Quad Outer Frame and Quad Tile Tray

- 2mm thick high grade
- 304 stainless steel
- Tile size: 107mm x 107mm
- Ease of assembly and installation being the final components installed

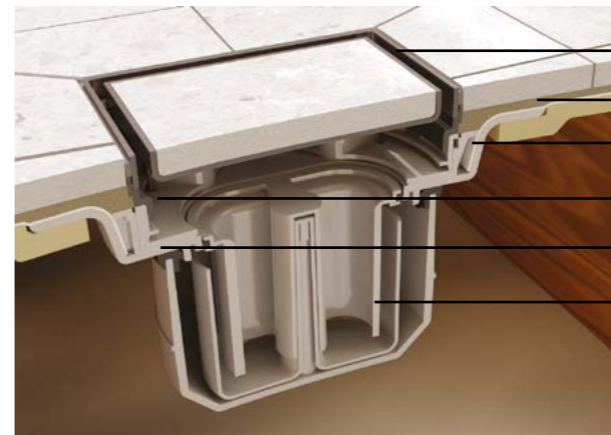

- Tile (up to 10mm), tile tray, outer frame
- Aqua-Dec EasyFit floor former
- WaterGuard
- Patented height adjustment (14mm-24mm)
- WaterGuard membrane clamping ring
- Removable diptube and bucket

## Tiled Insert for Linear Drain

The Linear Tiled Insert Top is an alternative option from the Element Brushed Stainless Steel top which is supplied as standard with any of our Aqua-Dec Linear and Aqua-Grade Linear floor formers. The Tiled Insert option is designed to be used with tiles, simply by inserting the chosen tile into the frame. Drains with the Tiled Insert drain top include a WaterGuard clamp, for guaranteed watertightness, and a removable diptube and bucket alongside a lifter tool for ease of cleaning.

### Linear Tiled Insert 13mm\*

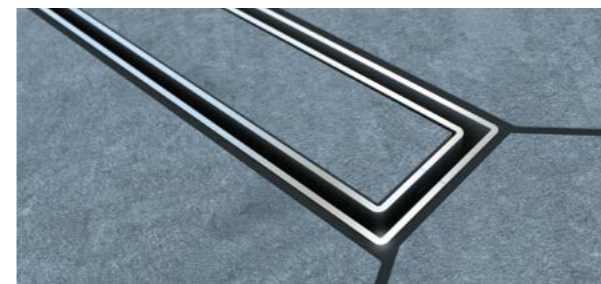

Available in 400mm, 600mm and 800mm, depending on floor former variant and size.

\*13mm fixed height from the floor former to the top of the tiling frame

### Linear Tiled Insert 24mm\*\*

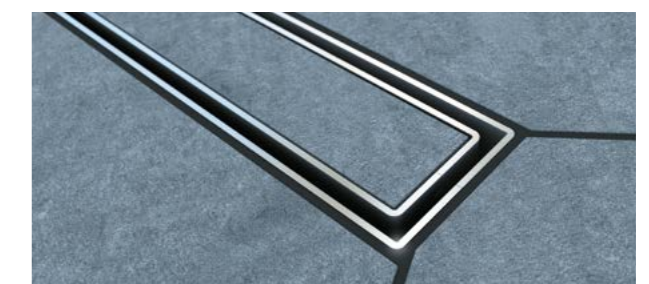

Available in 600mm and 800mm, depending on floor former variant and size.

\*\*24mm fixed height from the floor former to the top of the tiling frame

# Wetroom Screens



## Soho®

The Soho wetroom screen marries high-specification functionality with on-trend aesthetics to offer a unique, design-led option for wetrooms and shower areas.

Inspired by urban industrial partitioning, the high-quality aluminium-framed screen is powder coated in jet black boasting 8mm toughened safety glass; exposed frames on the outside of the unit, and visible screws to enhance the screen's authentic appeal. As part of Impey's complete wetroom solutions portfolio, 'Soho' is available in a variety of sizes and configurations to create your perfect showering situation. A wetroom system combined with Soho offers the ideal opportunity to add style and appeal to your bathroom.

**The Soho range is designed to be installed on an Impey wetroom floor former and cannot be installed on a traditional shower tray.**



Toughened glass









Stay clean glass

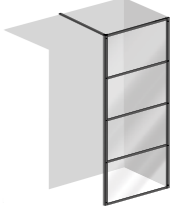

Guarantee

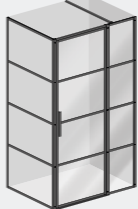
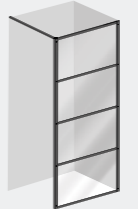
Example applications and the required product types (right hand configurations shown)

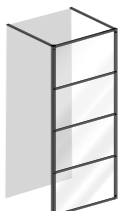
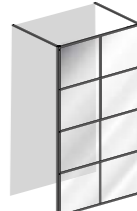
	Hinged		Walk-in / Walk-through	
Alcove 3 walls	 <ul style="list-style-type: none"> <li>• Hinged door</li> </ul>	 <ul style="list-style-type: none"> <li>• Hinged door with in-line panel</li> </ul>	 <ul style="list-style-type: none"> <li>• Horizontal panel</li> </ul>	
Corner 2 walls	 <ul style="list-style-type: none"> <li>• Hinged door</li> <li>• Side panel</li> </ul>	 <ul style="list-style-type: none"> <li>• Hinged door with in-line panel</li> <li>• Side panel</li> </ul>	 <ul style="list-style-type: none"> <li>• Horizontal panel</li> </ul>	 <ul style="list-style-type: none"> <li>• Vertical panel</li> </ul>
1 wall	N/A		 <ul style="list-style-type: none"> <li>• Horizontal panel</li> <li>• Additional bracing bar</li> </ul>	 <ul style="list-style-type: none"> <li>• Vertical panel</li> <li>• Additional bracing bar</li> </ul>

# Coram Showers Premier 8 Wetroom Screen

Always seen as an impressive feature, this design draws the eye to boast an expansive room whilst also fashioning the spacious shower enclosure itself. Standing at 2000mm high, this semi-frameless design comes in a variety of widths and configurations.

Bottom chrome trim provided as standard.

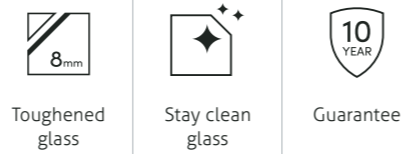

## Configurations

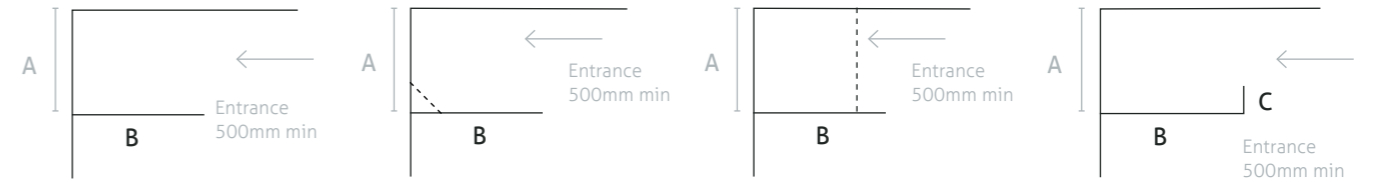

### Single panel

A	Fixing bracket depth: 1200mm max
B	Panel size options: 700, 800, 900

### Single panel with angled Bracing Bar

A	Fixing bracket depth: 1200mm max
B	Panel size options: 700**, 800**, 900**, 1000, 1100 and 1200

### Single panel with straight Bracing Bar

A	Fixing bracket depth: 1200mm max
B	Panel size options: 700**, 800**, 900**, 1000, 1100 and 1200

### Single panel with fixed Return Panel

A	Fixing bracket depth: 1200mm max
B	Panel size options: 700**, 800**, 900**, 1000, 1100 and 1200
C	Return Panel options: 200 or 300

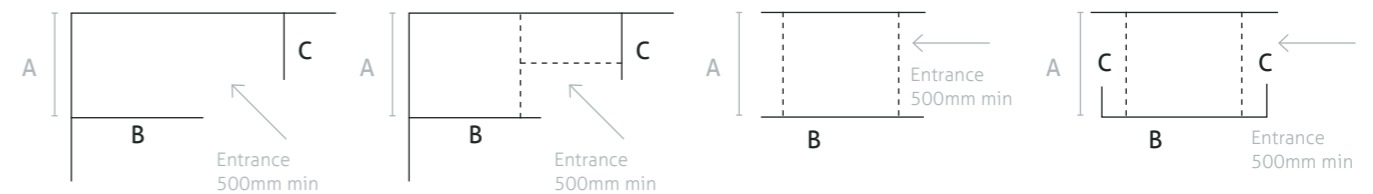

### Two fixed panels

A	Fixing bracket depth: 1200mm max
B + C	Panel size options: 700**, 800**, 900**, 1000, 1100 and 1200

### Two fixed panels with T-Bar\*\*\*

A	Fixing bracket depth: 1200mm max
B + C	Panel size options: 700**, 800**, 900**, 1000, 1100 and 1200

### Walk-through

A	Fixing bracket depth: 1200mm max
B	Panel size options: 1000*, 1100* and 1200*

### Walk-through with fixed Return Panels



A	Fixing bracket depth: 1200mm max
B	Panel size options: 1000*, 1100* and 1200*
C	Return Panel options: 200 or 300

\*Please note for walk-through panel sizes of 1000, 1100 or 1200 you will need an additional Bracing Bar.  
 \*\*Other formats are available to suit your specific requirements. These are just a few of the possible configurations.  
 \*\*\*Please note 700, 800 and 900mm Glass Screens are not sold with a Bracing Bar.  
 \*\*\*\*T-Bar to be purchased separately.

# Coram Showers Column Wetroom Screen

The 8mm glass panel is supported by a floor-to-ceiling chrome column using our Tigerfix fitting. The top section of the column is telescopic, which means it can be adjusted in height from 2027mm to 2700mm. This panel can be configured as a walk-in or walk-through, to suit your needs.

TigerFix is included.

 <b>8mm</b>	 <b>Stay clean glass</b>	 <b>10 YEAR</b> <b>Guarantee</b>
Toughened glass	Stay clean glass	Guarantee

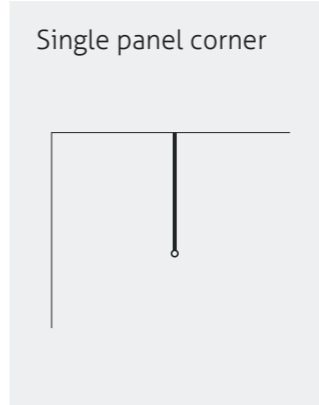
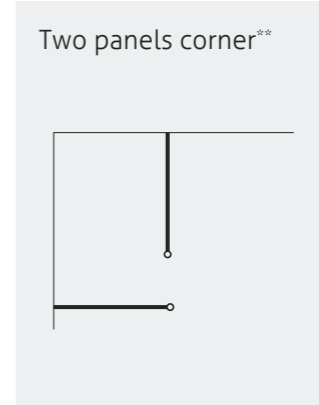
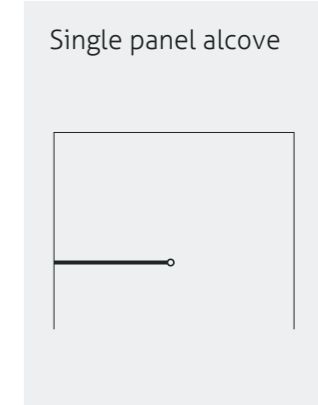

## Configurations

<p>Walk-through*</p> 	<p>Single panel corner</p> 	<p>Two panels corner**</p> 	<p>Single panel alcove</p> 
--	--	--	--

\* Requires purchase of additional pole.  
 \*\* Recommended 500mm for ease of access.



## What is TigerFix?

Included with the Column wetroom screen, TigerFix is an innovative adhesive solution that allows you to easily install Glass Screens without the need for drilling or fixing.

# Specifications

## Wetroom Floor Formers

Aqua-Dec Linear 2™	30
Aqua-Dec Linear 3™	30
Aqua-Dec Linear 4™	30
Aqua-Dec EasyFit™	31
Aqua-Grade™	32
Aqua-Grade Linear™	33

## Drainage

Tiled Floor Drain – Gravity	34
Tiled Floor Drain – Pumped	34
Tiled Floor Drain – Slim+	34
Vinyl Floor Drain – Gravity	34
Linear Floor Drain – Gravity	35

## Underfloor Heating

Aqua-Mat™	35
Thermostats	35

## Waterproofing

WaterGuard™ Tanking Kits	36
--------------------------	----

## Wetroom screens

Soho®	37
Premier 8	38
Column	38



# Aqua-Dec Linear™



All Aqua-Dec Linear floor formers are supplied with linear drain as shown, horizontal outlet and brushed stainless steel top.

All Aqua-Dec Linear floor formers are 22mm thick at the outer rim to be the same depth as most commonly used flooring materials.

NB: Trimming the edges is only possible on the Aqua-Dec Linear 3 range, except for the 1200mm x 900mm which cannot be trimmed.

Linear drain requires a minimum 95mm clearance below the Aqua-Dec.

Vertical waste available upon request.

Element Stainless Steel drain top comes as standard. 600mm and 800mm Tiled Insert options available on request.

## Aqua-Dec Linear 2

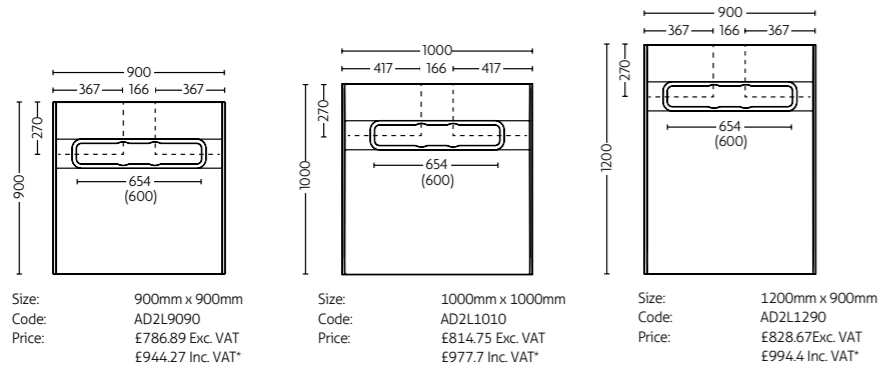

High flow rates of up to 40 litres per minute depending on the room layout and the size of Aqua-Dec Linear 2. Under boarding required.

## Aqua-Dec Linear 3

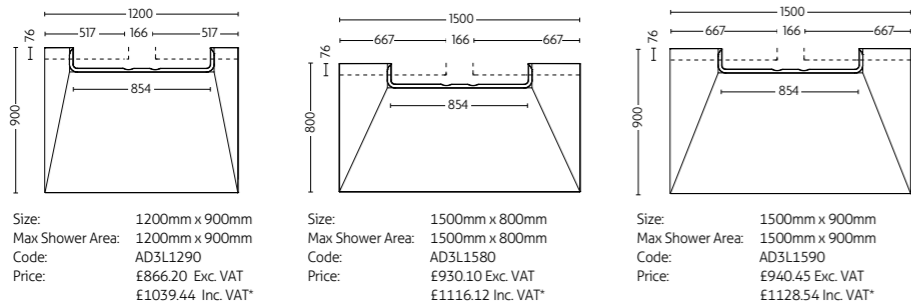

High flow rates of up to 40 litres per minute depending on the room layout and the size of Aqua-Dec Linear 3. Under boarding required.  
The sides may be trimmed up to 75mm from the central waste.

## Aqua-Dec Linear 4

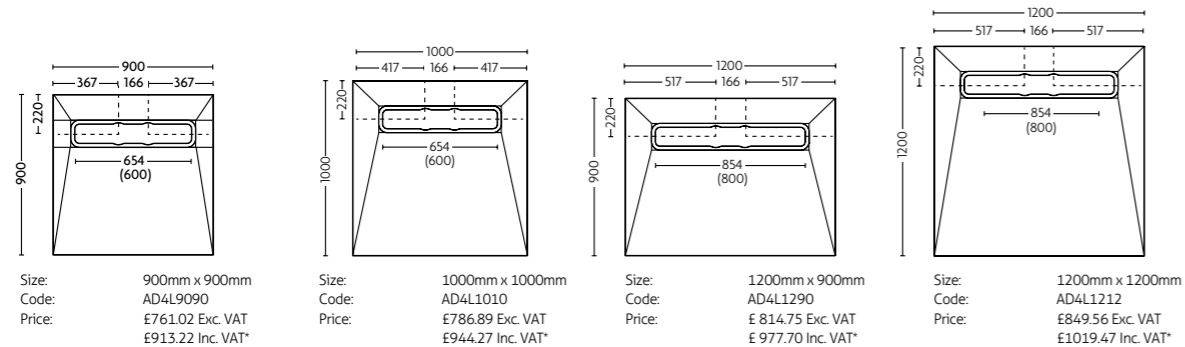

## Aqua-Dec Linear 4 cont.

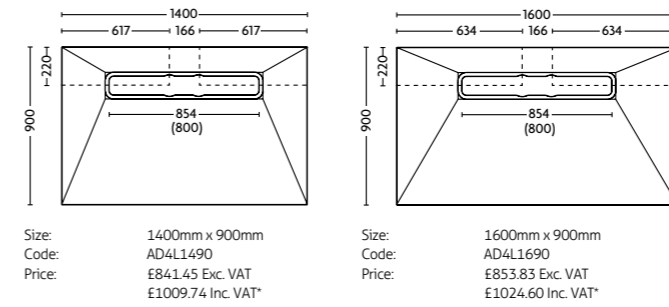

High flow rates of up to 40 litres per minute depending on the room layout and the size of Aqua-Dec Linear 4. Under boarding required.

# Aqua-Dec EasyFit™

All Aqua-Dec EasyFit floor formers are supplied with brushed stainless steel grate as shown and a UTTO1/H Tiled Floor Gully horizontal outlet as standard. No under boarding required.

Alternative drainage solutions and drain top available on request.

Slot drain top supplied as standard. Tiled Insert option available on request.



22 I

All Aqua-Dec EasyFit floor formers are 22mm thick at the outer rim to be the same depth as most commonly used flooring materials.

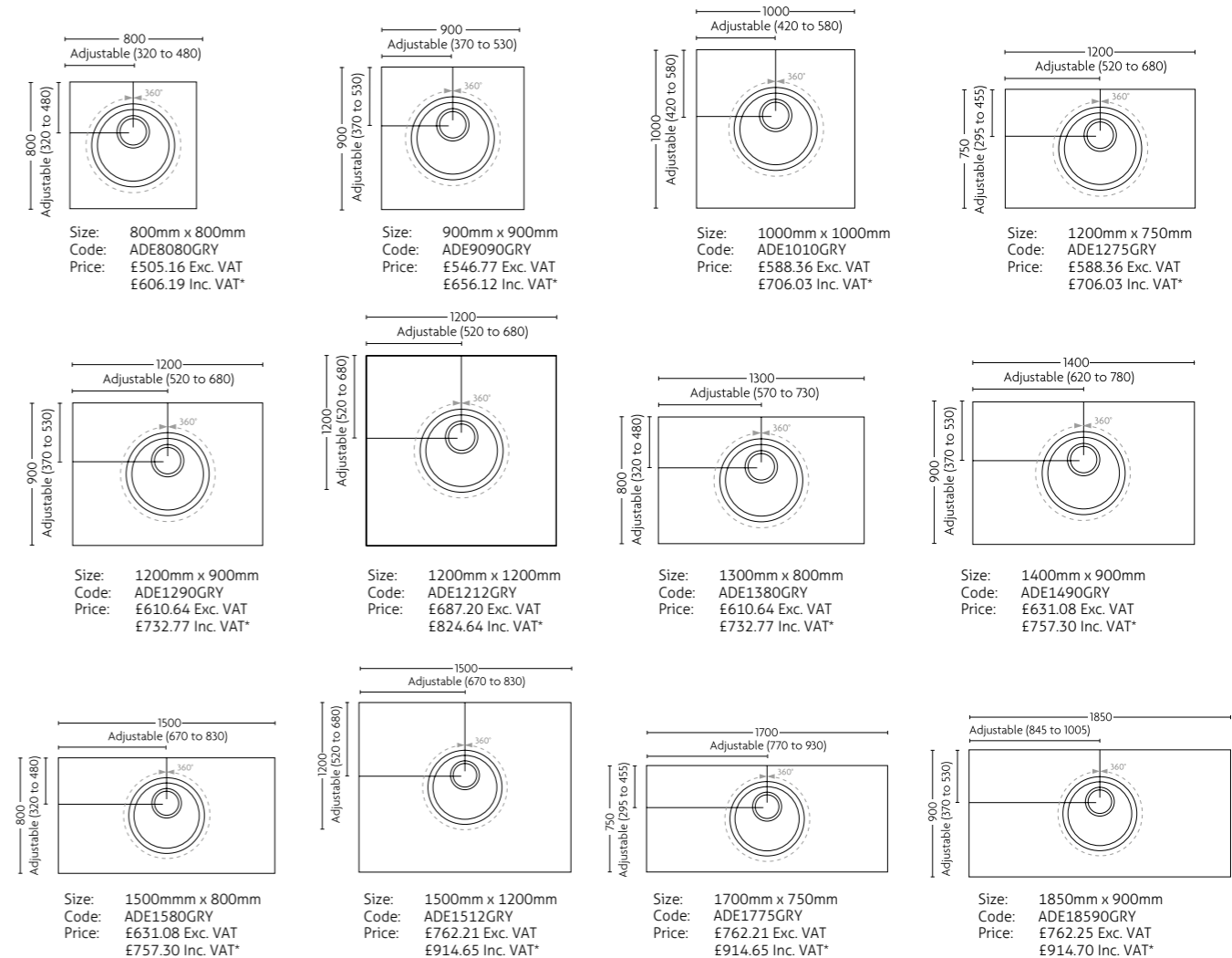

\*VAT at 20%, correct at time of going to print.

Can be installed directly onto floor joists at 415mm centres with no additional support or bedded into screeded floors.

\*VAT at 20%, correct at time of going to print. † For joists under 415mm - centre to centre spacing.



# Aqua-Grade™ System

Aqua-Grade provides a quick and easy alternative way of creating the perfect gradient for new pour solid floors. Colour coded modular sections click together to form any size of matrix - which you then simply fill with screed, reducing installation time by up to 50%. Available in centre drain and linear versions.

## Aqua-Grade



All Aqua-Grades are supplied with brushed stainless steel grate as shown and a UTTO1/H Tiled Floor Gully horizontal outlet as standard.

For alternative drainage and grate options for tiled and vinyl floors see page 30.

Foot mounting plates for mounting on insulation are available (if required). Pack of 25

Code: SCR/IMP/25 Price: £16.81 Exc. VAT £20.17 Inc. VAT\*

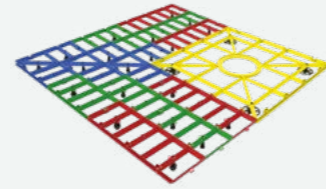

### One Wall - Three Falls

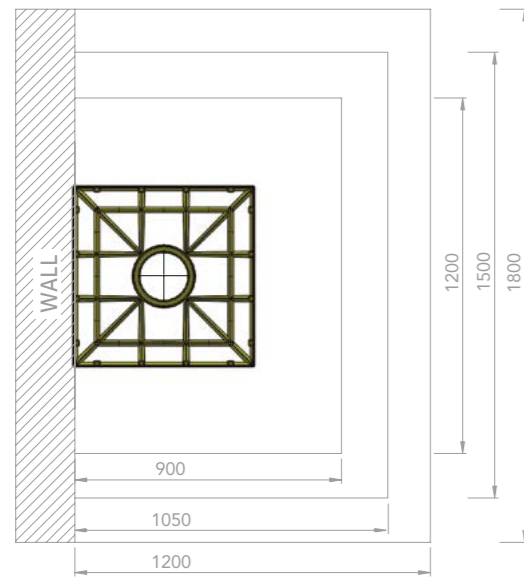

### Two Walls - Two Falls

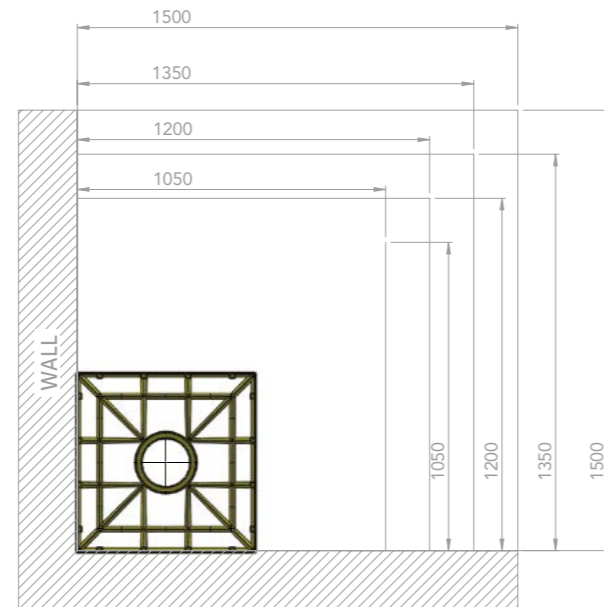

### No Wall - Four Falls

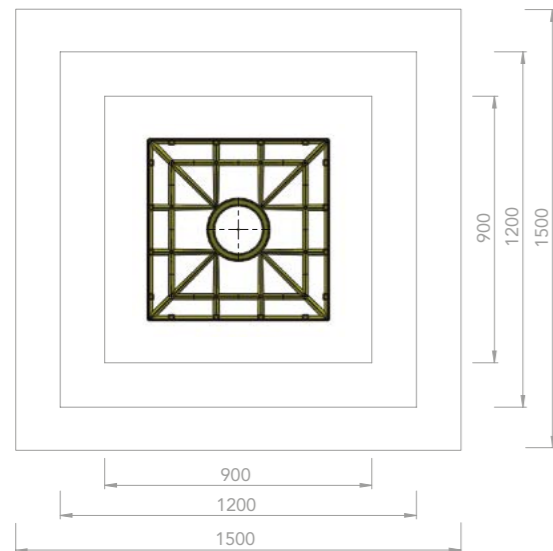

Aqua-Grade Square - One Wall - Three Falls			
Size: 1500mm x 1050mm	Code: AG150105/3F	Price: £407.08 Exc. VAT	£488.50 Inc. VAT*
1200mm x 900mm	Code: AG12090/3F	Price: £313.38 Exc. VAT	£376.06 Inc. VAT*
1800mm x 1200mm	Code: AG180120/3F	Price: £526.24 Exc. VAT	£631.49 Inc. VAT*

Aqua-Grade Square - Two Walls - Two Falls			
Size: 1050mm x 1050mm	Code: AG105105/2F	Price: £318.59 Exc. VAT	£382.31 Inc. VAT*
1200mm x 1200mm	Code: AG120120/2F	Price: £359.67 Exc. VAT	£431.60 Inc. VAT*
1350mm x 1350mm	Code: AG135135/2F	Price: £468.17 Exc. VAT	£561.80 Inc. VAT*
1500mm x 1500mm	Code: AG150150/2F	Price: £556.43 Exc. VAT	£667.72 Inc. VAT*

Aqua-Grade Square - No Wall - Four Falls			
Size: 900mm x 900mm	Code: AG9090/4F	Price: £259.47 Exc. VAT	£311.36 Inc. VAT*
1200mm x 1200mm	Code: AG120120/4F	Price: £379.52 Exc. VAT	£455.42 Inc. VAT*
1500mm x 1500mm	Code: AG150150/4F	Price: £533.54 Exc. VAT	£640.25 Inc. VAT*

\*VAT at 20%, correct at time of going to print.

Looking for installation advice? Call the technical team on: 01460 256080

## Aqua-Grade Linear



All Aqua-Grade Linear floor formers are supplied with linear drain, horizontal outlet and brushed stainless steel top.

Foot mounting plate is available (if required).

Pack of 25

Code: SCR/IMP/25

Price: £16.81 Exc. VAT £20.17 Inc. VAT\*

Alternative drainage solutions and drain top available on request.

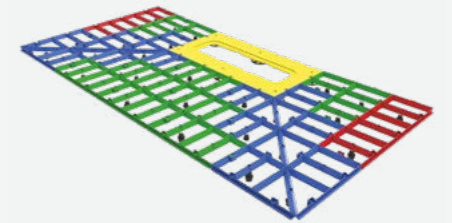

### 400mm Linear

Aqua-Grade 400mm Linear - Two Falls			
Size: 1200mm x 900mm	Code: AG40L12090/2F	Price: £531.12 Exc. VAT	£637.34 Inc. VAT*
1350mm x 1050mm	Code: AG40L135105/2F	Price: £446.69 Exc. VAT	£536.03 Inc. VAT*
1500mm x 1200mm	Code: AG40L150120/2F	Price: £525.10 Exc. VAT	£630.12 Inc. VAT*

Aqua-Grade 400mm Linear - Three Falls			
Size: 1500mm x 750mm	Code: AG40L15075/3F	Price: £600.41 Exc. VAT	£720.49 Inc. VAT*
1800mm x 900mm	Code: AG40L18090/3F	Price: £616.29 Exc. VAT	£739.55 Inc. VAT*

Aqua-Grade 400mm Linear - Four Falls			
Size: 1200mm x 900mm	Code: AG40L12090/4F	Price: £520.29 Exc. VAT	£624.35 Inc. VAT*
1500mm x 1200mm	Code: AG40L150120/4F	Price: £653.59 Exc. VAT	£784.31 Inc. VAT*

### 600mm Linear

Aqua-Grade 600mm Linear - One Fall			
Size: 900mm x 900mm	Code: AG60L9090/1F	Price: £498.12 Exc. VAT	£597.74 Inc. VAT*
1200mm x 900mm	Code: AG60L12090/1F	Price: £553.39 Exc. VAT	£664.07 Inc. VAT*
1350mm x 900mm	Code: AG60L13590/1F	Price: £545.70 Exc. VAT	£654.84 Inc. VAT*
1500mm x 900mm	Code: AG60L15090/1F	Price: £518.05 Exc. VAT	£621.66 Inc. VAT*

Aqua-Grade 600mm Linear - Two Falls			
Size: 1350mm x 750mm	Code: AG60L13575/2F	Price: £531.25 Exc. VAT	£637.50 Inc. VAT*
1500mm x 900mm	Code: AG60L15090/2F	Price: £534.77 Exc. VAT	£641.72 Inc. VAT*
1650mm x 1050mm	Code: AG60L165105/2F	Price: £670.83 Exc. VAT	£805.00 Inc. VAT*

Aqua-Grade 600mm Linear - Three Falls			
Size: 1800mm x 750mm	Code: AG60L18075/3F	Price: £605.60 Exc. VAT	£726.72 Inc. VAT*

Aqua-Grade 600mm Linear - Four Falls			
Size: 1500mm x 900mm	Code: AG60L15090/4F	Price: £590.59 Exc. VAT	£708.71 Inc. VAT*
1800mm x 1200mm	Code: AG60L180120/4F	Price: £751.64 Exc. VAT	£901.97 Inc. VAT*

### 800mm Linear

Aqua-Grade 800mm Linear - One Fall			
Size: 1050mm x 1050mm	Code: AG80L105105/1F	Price: £666.85 Exc. VAT	£800.22 Inc. VAT*
1200mm x 1050mm	Code: AG80L120105/1F	Price: £620.10 Exc. VAT	£744.12 Inc. VAT*
1350mm x 1050mm	Code: AG80L135105/1F	Price: £630.24 Exc. VAT	£756.29 Inc. VAT*
1500mm x 1050mm	Code: AG80L150105/1F	Price: £701.43 Exc. VAT	£841.72 Inc. VAT*

Aqua-Grade 800mm Linear - Two Falls			
Size: 1500mm x 750mm	Code: AG80L15075/2F	Price: £681.97 Exc. VAT	£818.36 Inc. VAT*

Aqua-Grade 800mm Linear - Three Falls			
Size: 1950mm x 750mm	Code: AG80L19575/3F	Price: £692.15 Exc. VAT	£830.58 Inc. VAT*

Aqua-Grade 800mm Linear - Four Falls			
Size: 1650mm x 900mm	Code: AG80L16590/4F	Price: £625.19 Exc. VAT	£750.23 Inc. VAT*

### No Walls - Four Falls

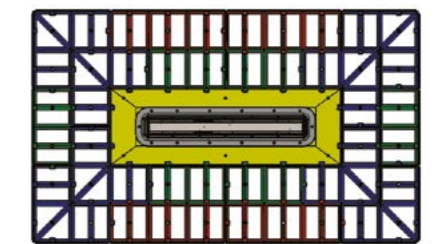

Available as 400mm, 600mm and 800mm

### One Wall - Three Falls

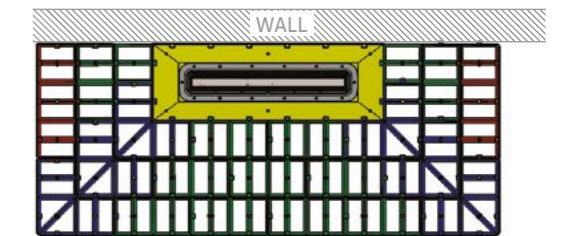

Available as 400mm, 600mm and 800mm

### Two Walls - Two Falls

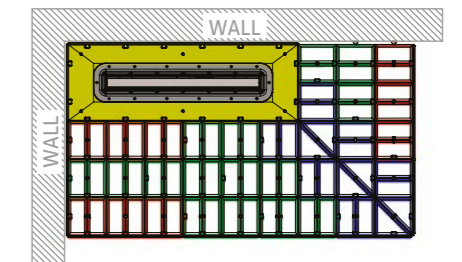

Available as 400mm, 600mm and 800mm

### Three Walls - One Fall

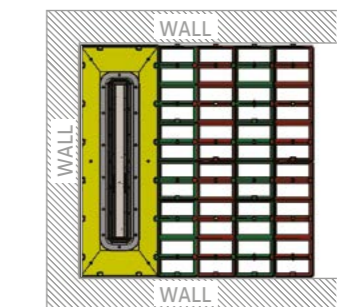

Available as 600mm and 800mm

\*VAT at 20%, correct at time of going to print.

# Drainage

## Impey Universal system

The Impey Universal Trap comprises a set of interchangeable components which are combined to make a range of drain products. The range includes both linear and wet floor drains for use in corresponding Impey floor former systems, as well as standalone linear drains for use in a concrete screeded floor.

The term 'Universal Trap' is used in reference to the trap and sump components which are shared across all drain configurations.

## Square Drainage

### Tiled Floor Drain - Gravity

All Aqua-Dec EasyFit and Aqua-Grade floor formers are supplied with a UTT01/H tiled floor gully with a horizontal outlet - a high quality water tray featuring a 50mm water seal and fixed 43mm outlet\*. A vertical outlet, or alternative drainage solutions are available on request. All drainage solutions come complete with a stainless steel drain top.

\*\*As a 1:40 fall

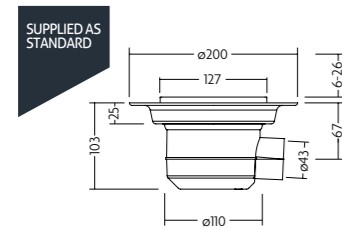

Quad Gravity Drain Slot - Horizontal Outlet

Code: UTT01/H  
Price: £171.62 Exc. VAT £205.94 Inc. VAT\*

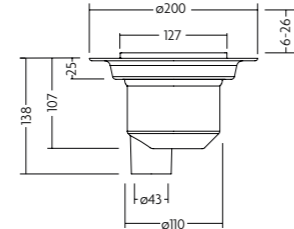

Quad Gravity Drain Slot - Vertical Outlet

Code: UTT01/V  
Price: £171.62 Exc. VAT £205.94 Inc. VAT\*

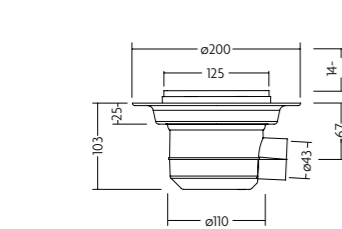

Quad Gravity Drain Tiled Insert 14mm - Horizontal Outlet

Code: QUADT14/H

When purchased separately as a standalone drain:

Price: £246.62 exc. VAT Price: £295.94 inc. VAT\*

Available as an upgrade ONLY when purchasing a floor former:

Price: £75.00 exc. VAT Price: £90.00 inc. VAT\*

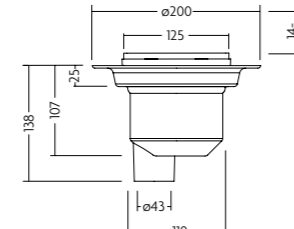

Quad Gravity Drain Tiled Insert 14mm - Vertical Outlet

Code: QUADT14/V

When purchased separately as a standalone drain:

Price: £246.62 exc. VAT Price: £295.94 inc. VAT\*

Available as an upgrade ONLY when purchasing a floor former:

Price: £75.00 exc. VAT Price: £90.00 inc. VAT\*

## Alternative drainage options for tiled or vinyl floors

### Tiled Floor Drain - Pumped

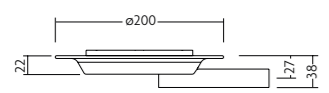

Tiled Floor Gully - For Pumped Waste

Code: DSS2  
Price: £162.86 Exc. VAT £195.43 Inc. VAT\*

For support and advice on Whale Shower Waste Pumps, please contact our Technical Team.

### Tiled Floor Drain - Slim+

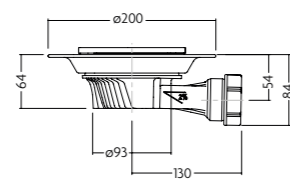

Tiled Drain Slim+ Horizontal Slot

Code: SLW2T01/H  
Price: £250.00 Exc. VAT £300.00 Inc. VAT\*

### Vinyl Floor Drain - Gravity

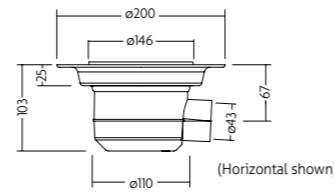

Vinyl Floor Gully - Horizontal Outlet

Code: UTVC01/H(CHROME)  
Price: £123.25 Exc. VAT £147.90 Inc. VAT\*

### Vinyl Floor Gully - Vertical Outlet

Code: UTVC01/V(CHROME)  
Price: £123.25 Exc. VAT £147.90 Inc. VAT\*

\*VAT at 20%, correct at time of going to print.

# Linear Floor Drain - Gravity | Aqua-Mat™

All Aqua-Dec Linear and Aqua-Grade Linear come with a Gravity drain with horizontal outlet and Element Drain Top as standard. These drains feature a 50mm water seal and 43mm outlet\*\*.

\*\*As a 1:40 fall

## Element Brushed Stainless Steel

Drains with the Element drain top include a WaterGuard clamp, for guaranteed watertightness, and a removable diptube and bucket alongside a lifter tool for ease of cleaning. The Element drain top is height adjustable from 6mm - 26mm, to suit varying tile depths and use with underfloor heating.

When bought separately as a standalone linear drain:

400mm LNR40S/H or V	Price: £294.60 Exc. VAT	£353.52 Inc. VAT*
600mm LNR60S/H or V	Price: £320.59 Exc. VAT	£384.71 Inc. VAT*
800mm LNR80S/H or V	Price: £346.58 Exc. VAT	£415.90 Inc. VAT*

## Tiled Insert 13mm

Drains with the Tiled Insert 13mm drain top include a WaterGuard clamp, for guaranteed watertightness, and a removable diptube and bucket alongside a lifter tool for ease of cleaning. The Tiled Insert 13mm Drain top has a fixed height of 13mm from the floor former to the top of the tiling frame.

When purchased separately as a standalone linear drain:

400mm LNR40T8/H or V	Price: £357.01 exc. VAT	£428.41 inc. VAT*
600mm LNR60T8/H or V	Price: £386.22 exc. VAT	£463.46 inc. VAT*
800mm LNR80T8/H or V	Price: £412.21 exc. VAT	£494.65 inc. VAT*

Available as an upgrade ONLY when purchasing a Linear floor former:

400mm LNR40T8/H or V	Price: £23.52 exc. VAT	£28.22 inc. VAT*
600mm LNR60T8/H or V	Price: £43.40 exc. VAT	£52.08 inc. VAT*
800mm LNR80T8/H or V	Price: £52.08 exc. VAT	£62.50 inc. VAT*

## Tiled Insert 24mm

Drains with the Tiled Insert 24mm drain top include a WaterGuard clamp, for guaranteed watertightness, and a removable diptube and bucket alongside a lifter tool for ease of cleaning. The Tiled Insert 24mm Drain top has a fixed height of 24mm from the floor former to the top of the tiling frame.

When purchased separately as a standalone linear drain:

600mm LNR60T24/H or V	Price: £396.53 exc. VAT	£475.84 inc. VAT*
800mm LNR80T24/H or V	Price: £442.06 exc. VAT	£530.47 inc. VAT*

Available as an upgrade ONLY when purchasing a Linear floor former:

600mm LNR60T24/H or V	Price: £75.95 exc. VAT	£91.14 inc. VAT*
800mm LNR80T24/H or V	Price: £95.48 exc. VAT	£114.58 inc. VAT*

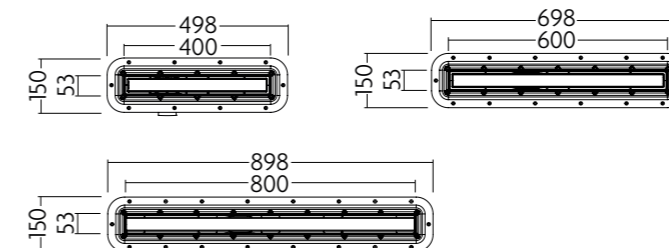

## Aqua-Mat 100W Size Options - suitable for wooden and concrete floors

Area to be Warmed m <sup>2</sup>	Heating Load Watts	Product Code	Retail Price Exc. VAT	Retail Price Inc. VAT*
1.0	100	AM1.0/V2	£81.66	£97.99
1.5	150	AM1.5/V2	£93.37	£112.04
2.0	200	AM2.0/V2	£108.63	£130.36
2.5	250	AM2.5/V2	£127.94	£153.53
3.0	300	AM3.0/V2	£143.19	£171.83
3.5	350	AM3.5/V2	£160.11	£192.13
4.0	400	AM4.0/V2	£176.25	£211.50
5.0	500	AM5.0/V2	£199.50	£239.40
6.0	600	AM6.0/V2	£227.99	£273.59
7.0	700	AM7.0/V2	£254.96	£305.95
8.0	800	AM8.0/V2	£278.91	£334.69
9.0	900	AM9.0/V2	£293.31	£351.97
10.0	1000	AM10.0/V2	£303.11	£363.73
12.0	1200	AM12.0/V2	£376.58	£451.90

## Aqua-Mat 150W Size Options - suitable for concrete floors

Area to be Warmed m <sup>2</sup>	Heating Load Watts	Product Code	Retail Price Exc. VAT	Retail Price Inc. VAT*
1.0	150	AM1.0/150V2	£90.93	£109.12
1.5	225	AM1.5/150V2	£105.63	£126.76
2.0	300	AM2.0/150V2	£128.60	£154.32
2.5	375	AM2.5/150V2	£165.25	£198.30
3.0	450	AM3.0/150V2	£183.71	£220.45
3.5	525	AM3.5/150V2	£193.81	£232.57
4.0	600	AM4.0/150V2	£202.09	£242.51
5.0	750	AM5.0/150V2	£248.01	£297.61
6.0	900	AM6.0/150V2	£284.76	£341.71
7.0	1050	AM7.0/150V2	£321.48	£385.78
8.0	1200	AM8.0/150V2	£358.24	£429.89
9.0	1350	AM9.0/150V2	£394.98	£473.98
10.0	1500	AM10.0/150V2	£431.72	£518.06
12.0	1800	AM12.0/150V2	£473.06	£567.67

## DEVireg Touch Thermostat

Product Code	Retail Price Exc. VAT	Retail Price Inc. VAT*
DMTBLACK	£154.05	£184.86
DMTWHITE	£154.05	£184.86

\*VAT at 20%, correct at time of going to print.

# WaterGuard™ Tanking Kit

WaterGuard provides the complete leak-proof sealing solution - not just for floors but also to walls thanks to Impey's unique and market-leading design.

INSTALLATION VIDEO GUIDE  
SCAN BELOW TO WATCH



Floor Kit Contents	Product Code	Retail Price Exc. VAT	Retail Price Inc. VAT*
<b>5m² of Impey WaterGuard membrane</b> with 500ml BAL primer, 15m jointing tape, 5 x internal corners, 1 x external corner, Butyl sealant	WG5.	£318.88	£382.66
<b>10m² of Impey WaterGuard membrane</b> with 500ml BAL primer, 20m jointing tape, 5 x internal corners, 1 x external corner, Butyl sealant	WG10.	£491.00	£589.20
<b>Wall Kit Contents</b>			
<b>10m² of Impey WaterGuard wall membrane</b> with 500ml BAL primer, 10m jointing tape, Butyl sealant	WG10W.	£399.87	£479.84
<b>Floor &amp; Wall Kit Contents</b>			
<b>5m² of Impey WaterGuard floor membrane and 10m² Impey WaterGuard wall membrane</b> with 15m jointing floor tape, 10m jointing wall tape, 5 x internal corners, 1 x external corner, 2 x Butyl sealant, 2 x 500ml BAL primer	WG15WF	£700.85	£841.02
<b>10m² of Impey WaterGuard floor membrane and 10m² Impey WaterGuard wall membrane</b> with 20m jointing floor tape, 10m jointing wall tape, 5 x internal corners, 1 x external corner, 2 x Butyl sealant, 2 x 500ml BAL primer	WG20WF	£849.34	£1019.21
<b>Additional components if required</b>			
<b>10m jointing tape</b>	WGJT10	£65.90	£79.08
<b>Internal corner</b>	WGIPC	£12.14	£14.57
<b>External corner</b>	WGIPC	£12.14	£14.57
<b>Butyl sealant</b>	WGJS	£12.83	£15.40
<b>500ml BAL primer</b>	WGPR	£28.01	£33.61

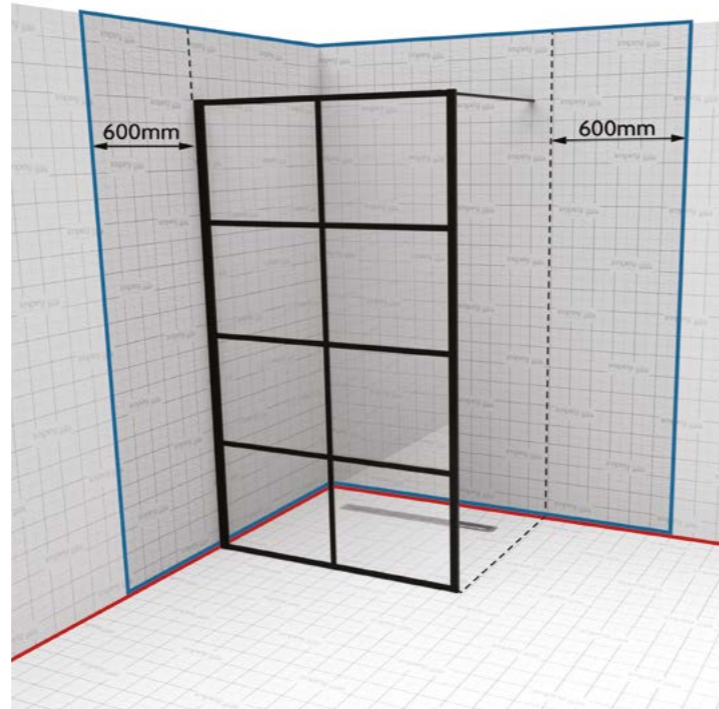

## WATERPROOF ZONING GUIDE

### Mandatory requirement

> **Red zone coverage** - The entire wetroom floor **MUST** be tanked with WaterGuard to qualify for our lifetime guarantee.

### Recommended

> **Red and Blue zone coverage** - The entire floor and walls immediately inside the wet area and extending 600mm beyond should be tanked to stop any water ingress into walls.

### Highly recommended

> **Complete coverage** - WaterGuard tanking throughout the entire wetroom (floors and walls) will create a seamless impenetrable wetroom, providing heat and sound insulation and decoupling throughout.

Install our WaterGuard™ system with any Aqua-Dec floor former and receive our Lifetime Watertight Guarantee. For further details please visit our website: [www.impeyshowers.com](http://www.impeyshowers.com)



\*VAT at 20%, correct at time of going to print.

# Soho® Wetroom Screen

Soho by Impey is a specialist wetroom product especially designed to be installed on our market leading wetroom floor formers.

**Note: Soho cannot be installed on a shower tray.**

## PANEL COMBINATIONS

Product Type	Size (mm)	Handing	Product Code	exc VAT	inc VAT*
Hinged door	800	Left	AH24SC01-80 LEFT	£885.70	£1062.84
	800	Right	AH24SC01-80 RIGHT	£885.70	£1062.84
	900	Left	AH24SC01-90 LEFT	£924.34	£1109.21
	900	Right	AH24SC01-90 RIGHT	£924.34	£1109.21
Hinged door with in-line panel	1200	Left	AH24SC01-120 LEFT	£1094.69	£1313.63
	1200	Right	AH24SC01-120 RIGHT	£1094.69	£1313.63
	1400	Left	AH24SC01-140 LEFT	£1150.66	£1380.79
	1400	Right	AH24SC01-140 RIGHT	£1150.66	£1380.79
Side panel	800	N/A	AH24SP02-80	£602.49	£722.99
	900	N/A	AH24SP02-90	£630.42	£756.50
Walk-in/walk-through horizontal panel	900	N/A	AW24SC01-N1-90	£717.78	£861.34
	1000	N/A	AW24SC01-N1-100	£739.61	£887.53
Walk-in/walk-through vertical panel	1200	N/A	AW24SC01-N1-120	£832.48	£998.98
	1400	N/A	AW24SC01-N1-140	£898.70	£1078.44
	Additional accessories				
Additional bracing bar	N/A	AH24-BAR100	£81.51	£97.81	
Angled bracing bar kit	N/A	AH24-BA01-KIT	£46.34	£55.61	
Ceiling bracing bar	N/A	AH24-BC01-KIT	£81.51	£97.81	
Additional profile	N/A	AH24-SP-KIT	£25.42	£30.50	



\*VAT at 20%, correct at time of going to print.

## Coram Showers Premier 8 Screen



Width (mm)	Height (mm)	Adjustment per profile (mm)	Adjustment range (mm)	Retail price (exc VAT)	Retail price (inc VAT)	Product code
700	2000	20	680 - 700	£321.71	£386.05	SP70C
800	2000	20	780 - 800	£350.10	£420.12	SP80C
900	2000	20	880 - 900	£369.03	£442.84	SP90C
1000	2000	20	980 - 1000	£397.42	£476.90	SP10C
1100	2000	20	1080 - 1100	£406.87	£488.24	SP11C
1200	2000	20	1180 - 1200	£425.80	£510.96	SP12C

Add on product	Retail price (exc. VAT)	Retail price (inc. VAT)	Product code
200mm - Return Panel pack / chrome / plain glass	£169.02	£202.82	SP02C
300mm - Return Panel pack / chrome / plain glass	£214.68	£257.62	SP03C
Additional 1.2m Bracing Bar for Premier 8 range / chrome	£99.25	£119.10	SPAB
Additional T Bar chrome	£71.78	£86.14	SPTB

## Coram Showers Column Screen



Width (mm)	Height (mm)	Adjustment per profile (mm)	Adjustment range (mm)	Retail price (exc VAT)	Retail price (inc VAT)	Product code
700	2000	20	716 - 736	£669.86	£803.83	ASC70CUC.
800	2000	20	816 - 836	£757.08	£908.50	ASC80CUC.
900	2000	20	916 - 936	£777.30	£932.76	ASC90CUC.
1000	2000	20	1016 - 1036	£832.92	£999.50	ASC10CUC.
1200	2000	20	1216 - 1236	£883.47	£1060.16	ASC12CUC.

Add on product	Retail price (exc. VAT)	Retail price (inc. VAT)	Product code
Additional floor to Ceiling Pole - for walk-through configuration	£159.51	£191.41	IASCT2000



### Contact Us

We have a dedicated Customer Services and Technical team who are on hand to offer a personalised solution to any queries regarding the Impey product range or installations.

Our opening hours are: 8:30am to 5pm Monday - Friday

Tel: 01460 256080

General enquiries or sales: [salesorders@impeyshowers.com](mailto:salesorders@impeyshowers.com)

Technical Support: [technical.support@impeyshowers.com](mailto:technical.support@impeyshowers.com)

Website: [www.impeyshowers.com](http://www.impeyshowers.com)

Head Office: Impey, Conquest House, Conquest Business Park, Cad Road, Ilton, Somerset TA19 9EA

Impey is part of Coram UK Holding Ltd



### The Coram International bathroom group

A Dutch family owned business with over 500 employees. Offices in the Netherlands, Belgium, United Kingdom, Poland & Norway. Exporting to more than 70 countries worldwide.



**Coram Showers:** A leading brand of shower enclosures, bath screens and shower trays with over 70 years of operation in the UK with very strong presence in plumbers merchant and bathroom retail sectors. Coram enclosures are designed to meet the highest aesthetic and functional standards expected whilst maintaining the reputation as a stylish and hassle-free range to install and maintain. Style with Standards.



**Tiger:** Founded in 1950, Tiger specialised in a manufacturing a wide range of plastic products for different applications. From bicycle handles to soap dishes. Tiger quickly became very successful in the Netherlands and in 1957 a start was made on exploring the international market. The Tiger brand grew quickly into international playing field with a wide range of bathroom accessories. The brand is recognised for it's design and innovation.

### Displays

For new or replacement wetroom display needs, please email our team via [displays@impeyshowers.com](mailto:displays@impeyshowers.com) who can offer advice and support on displaying wetrooms.

### Training Opportunities

Training available both online and in person. Visit [www.impeyshowers.com/for-installers/wet-room-installer-training](http://www.impeyshowers.com/for-installers/wet-room-installer-training) for details and to book your place.

### Quick Access

For instant navigation for Technical Datasheets, Installation Guides and Installation Videos, simply scan one of the below to be directed to the relevant webpage on our Impey website.



IMPEY TECHNICAL DATASHEETS



IMPEY INSTALLATION GUIDES



IMPEY INSTALLATION VIDEOS

01460 256080  
impeyshowers.com

---

@impeyshowers



ISO 9001:2015 ISO 14001:2015

Printed with biodegradable laminate:  
✓ protecting the environment from single use plastics  
✓ reducing negative impact on the environment.

Whilst every care has been taken to ensure that the information included in this document was accurate at the time of printing, we reserve the right to change product specifications at any time without prior notice. The photographs reproduced in this document publication are within the constraints of the printing process and are not to be used for matching purposes. All photographs are used for approximate representation only and may not show the actual products on offer. Errors and Omissions Excepted.

Full terms and conditions available at [www.impeyshowers.com](http://www.impeyshowers.com)